

# ***Advances in Vehicle Dynamics, Simulators, Safety and Controls***

***Hocine Imine***

*Email: [hocine.imine@univ-eiffel.fr](mailto:hocine.imine@univ-eiffel.fr)*

COSYS-PICSL, Perceptions, Interactions, Behaviors & Simulations **Lab**

for road and street users

*University Gustave Eiffel, France*

VEHICULAR 2020, The Ninth International Conference on Advances in  
Vehicular Systems, Technologies and Applications

## Short Bio

Imine received his Master Degree and his PhD in Robotics and Automation from Versailles University, France, respectively in 2000 and 2003. He received Accreditation to Supervise Research (Habilitation à Diriger des Recherches, HDR) on March 2012 from University of Valenciennes et du Hainaut Cambresis, France. In 2005, he joined IFSTTAR (Today University Gustave Eiffel), where he is currently Research Director. He is involved in different French and European projects. His research interests include Intelligent Transportation Systems, vehicle modeling and stability, diagnosis, nonlinear observation, nonlinear control. He published 2 books, over 80 technical papers, and several industrial technical reports.



# Summary

- *Introduction/Motivation*
- *Road characteristics*
- *Vehicle dynamics*
  - ✓ *States estimation*
  - ✓ *Impact forces identification*
- *Vehicle safety study*
  - ✓ *Rollover risk*
- *Experimental results*
- *Actual and future works*

# Context

The road accident can be caused by several factors

## Some data

- 92 % caused by driver (speed, presence of alcohol, fatigue ,..)
- **46% related to Infrastructure**
- 29% related to Vehicle
- 8% related to divers causes (Weather, Warning,..)

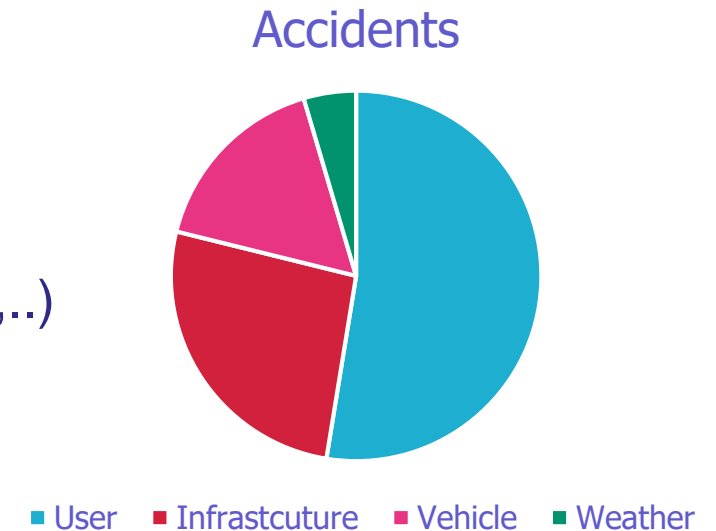

Different types of accidents:

- Lane departure (Transverse instability)
- Rollover (Roll instability)
- Jackknifing, implied especially in Heavy vehicle accidents (Yaw instability)

# Road characteristics

Geometric and surface characteristics of the road have a direct effect on the forces generated in the tire contact footprint, under the action of applied commands.

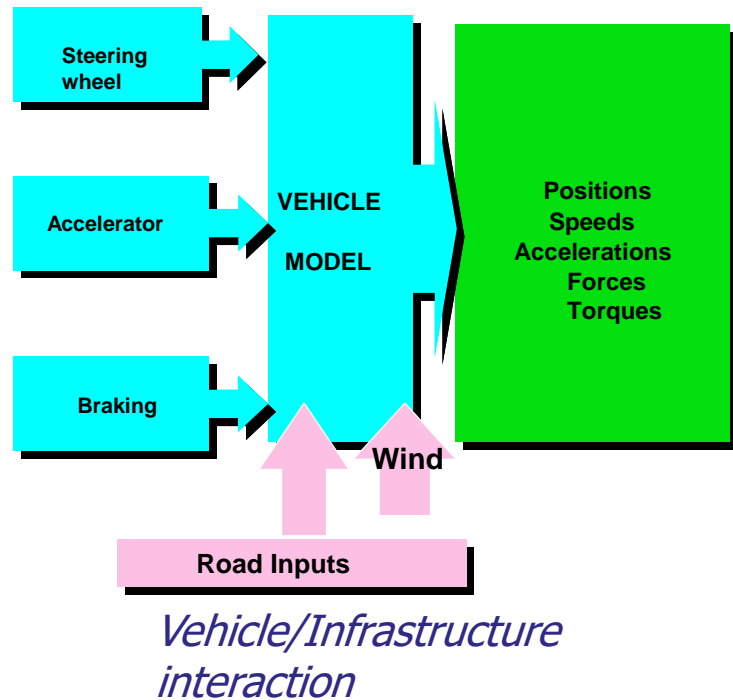

- Road Profile → Vertical deformation of the road
- Road adhesion → Skid resistance is a friction to prevent a tire from sliding along the pavement surface
- Longitudinal and lateral slope
- Radius of curvature

# Road characteristics

The radius of curvature, the longitudinal and lateral slopes are measured using Véhicule d'Analyse d'Itinéraire (VANI\*).

VANI was realized by the Regional Laboratory of Lyon, France.

It is equipped with different sensors : Gyrometers, GPS, laser sensors,...



\* G. Gratia, "VANI (Véhicule d'Analyse d'Itinéraire): Un matériel multifonction pour les études de sécurité," in *Bull. Liaison Lab. Ponts Chaussées*, Dec. 1994, no. Spécial 17, pp. 69–74.

# Road profile and Road adhesion in vehicle dynamics

- Road Profile → can cause rollover and control loss of the vehicle

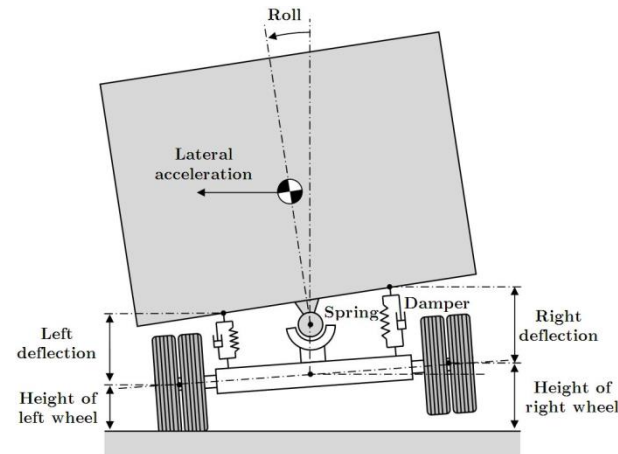

- Road adhesion → sliding and control loss, lane departure of the vehicle



# Road profile

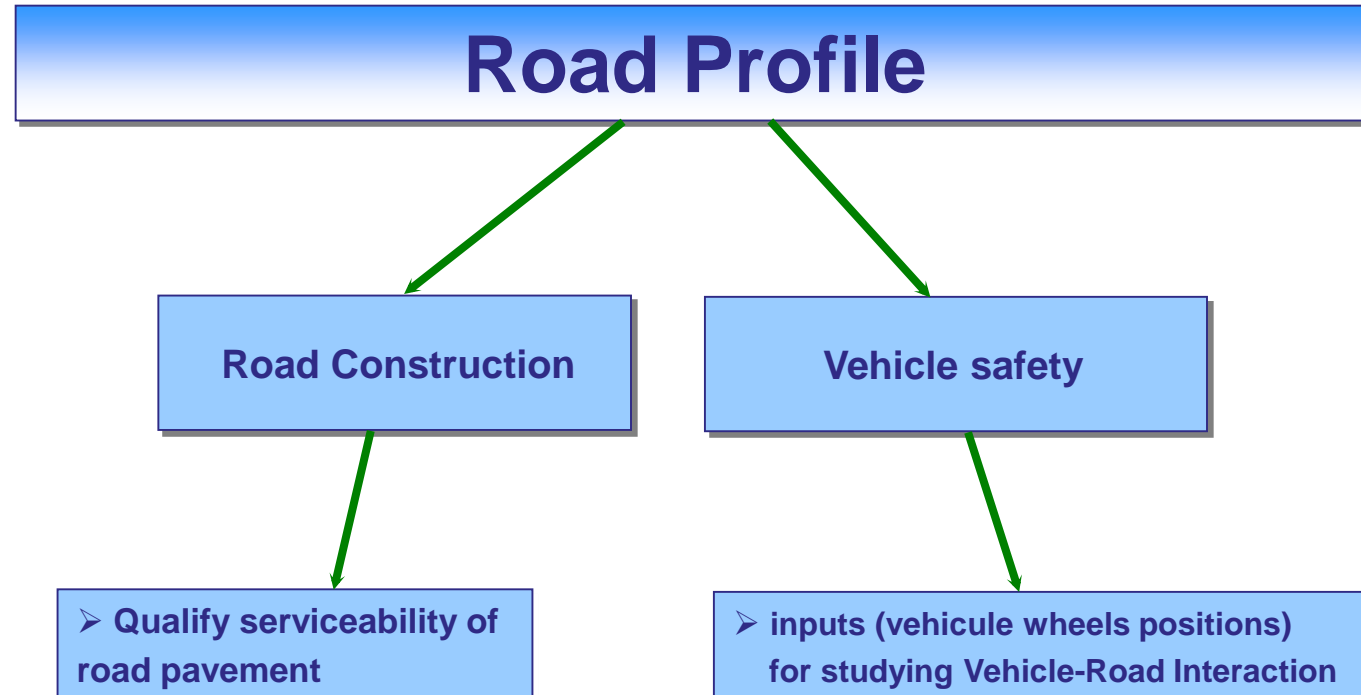

Several profiles ⇒ **road surface**



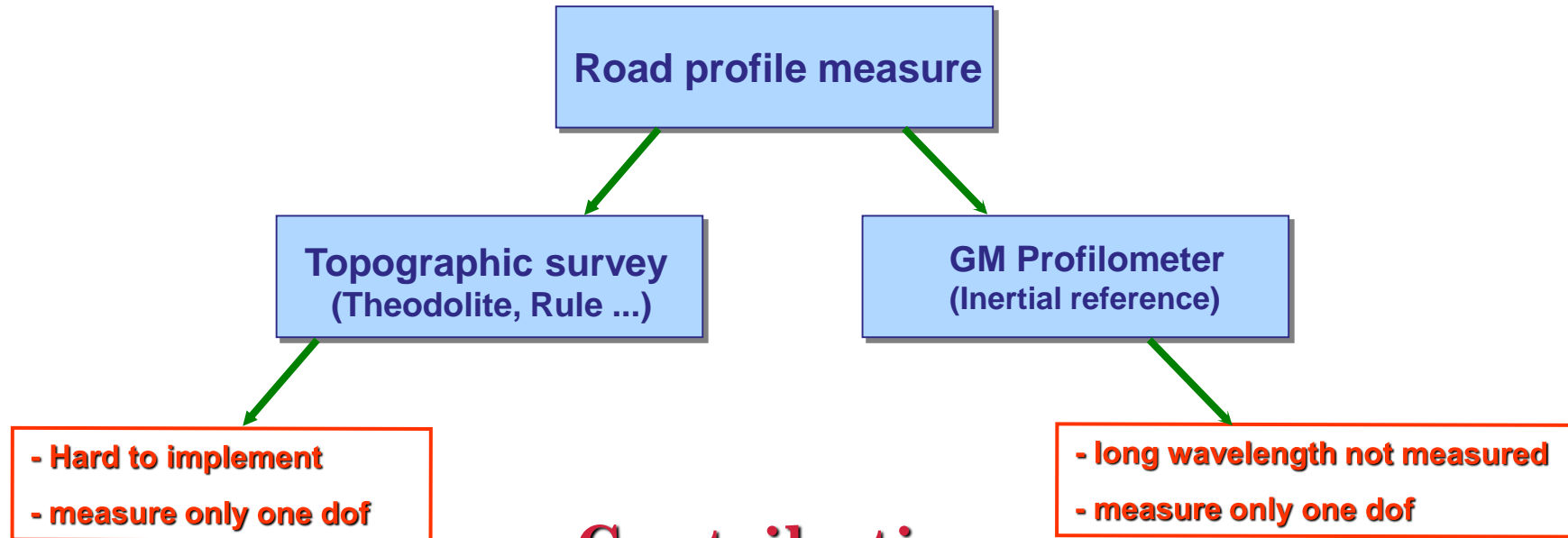

## Contribution

Develop an easily implemented method

- Based on non lineare observers
- Take into account a vehicle dynamic

# Reconstruction Methods



**Measured by  
Longitudinal Profile Analyser (APL\*)**

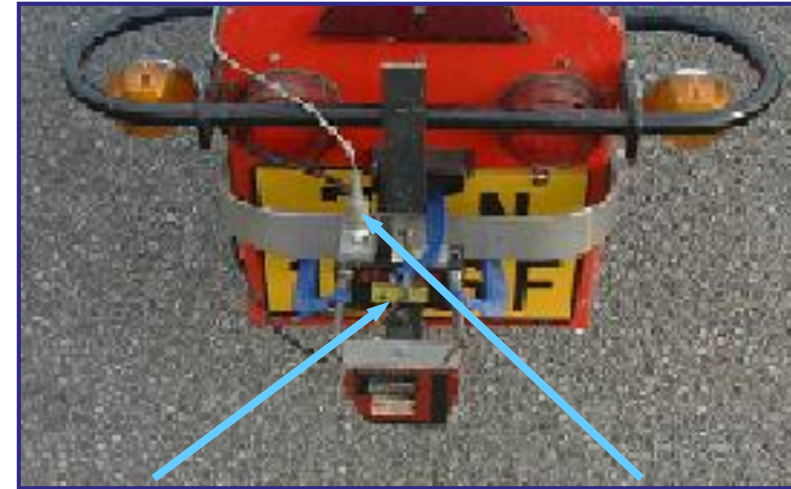

**Reconstruction by  
Inertial Method (GMR)**

\*H. Imine, Y. Delanne, and N. K. M'Sirdi, "Road profiles inputs estimation in vehicle dynamics simulation," *Int. J. Veh. Syst. Dyn.*, vol. 44, no. 4, pp. 285-303, 2006.

# APL measure

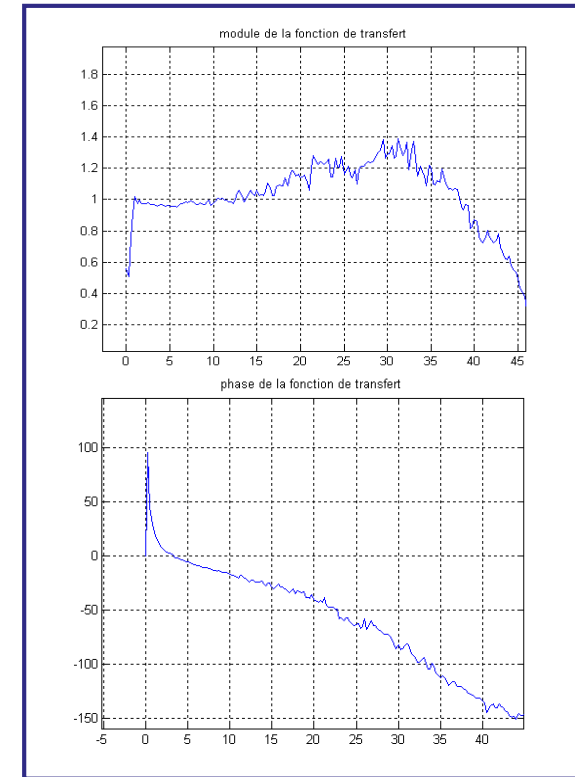
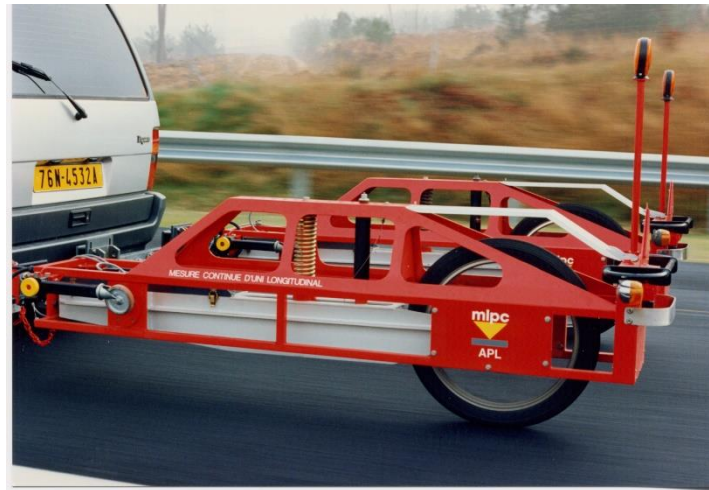
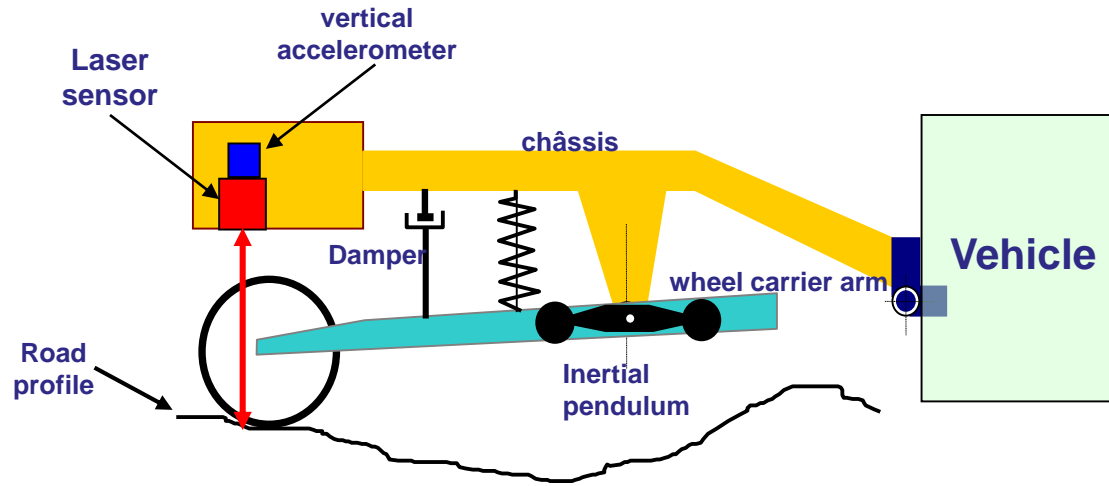

Transfert function

$$H(z) = K \frac{(1 - z^{-1})^3 (1 + z^{-1})^2}{(1 - p_0 z^{-1})(1 - p_1 z^{-1})(1 - p_1^* z^{-1})(1 - p_2 z^{-1})(1 - p_2^* z^{-1})}$$

# Inertial Method

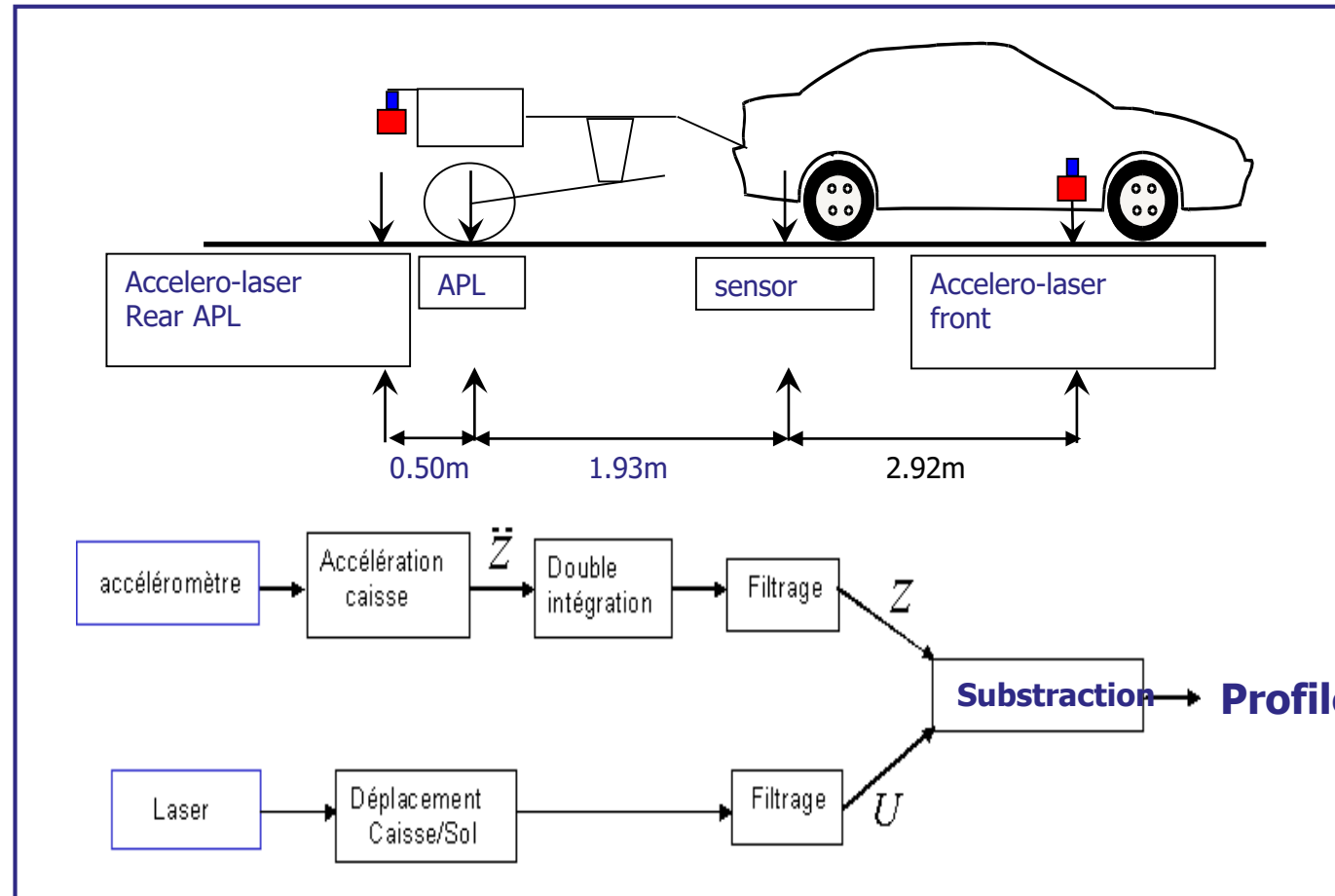

**Profile = Z - U**

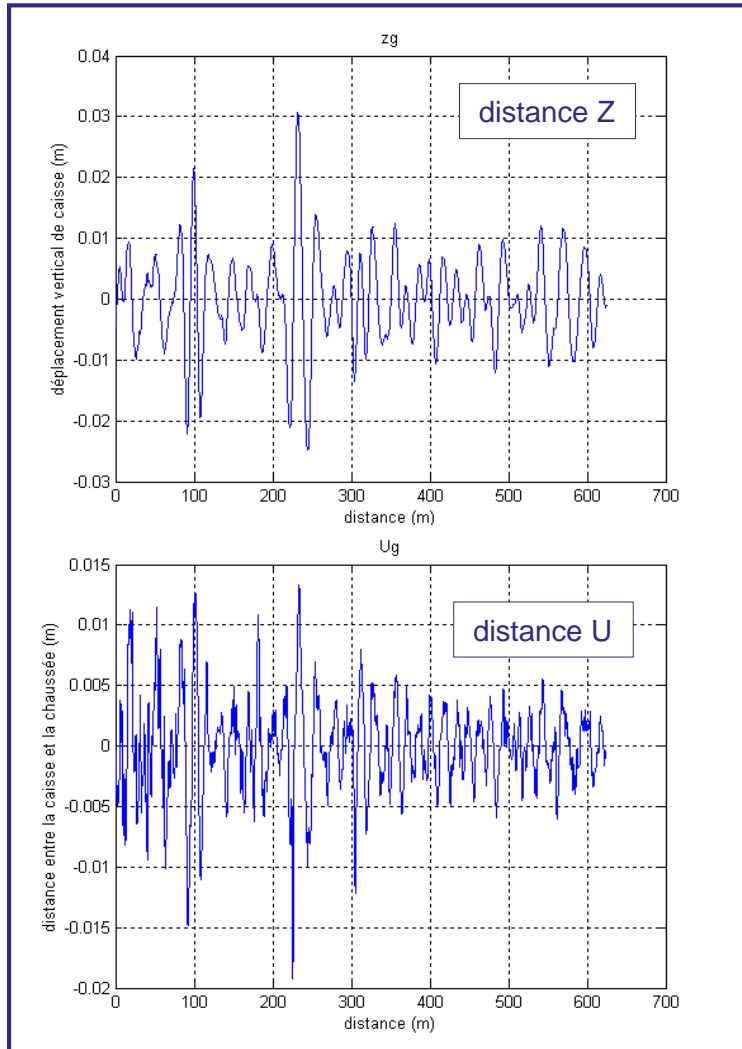

## Profile : APL and inertial method

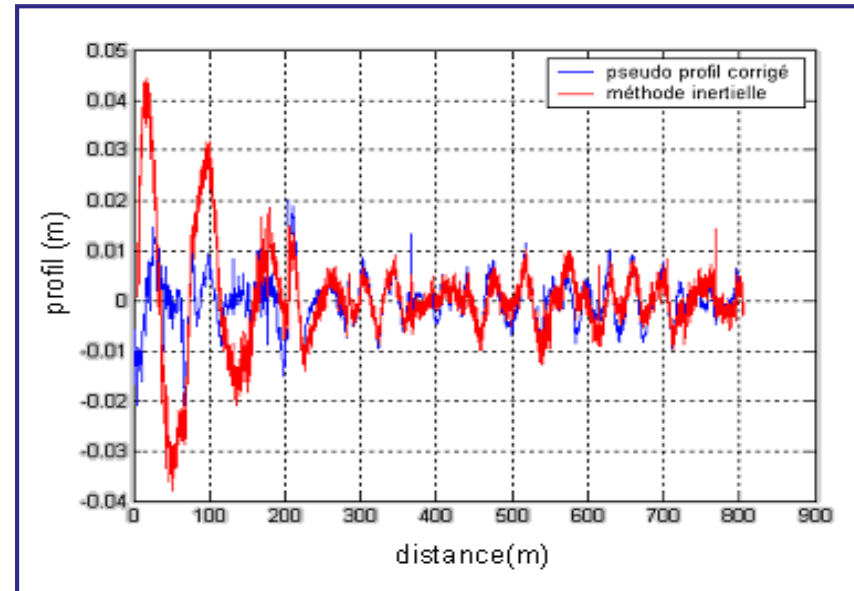
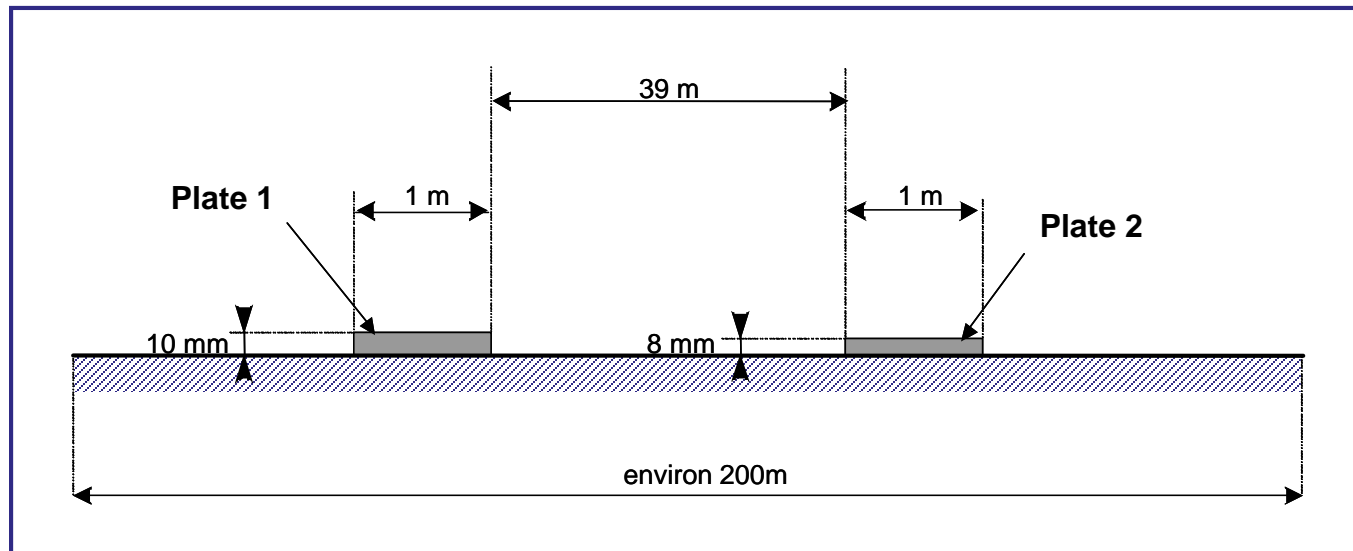

Plate on the track



Position of the plates on the track



## Reconstruction of the two plates

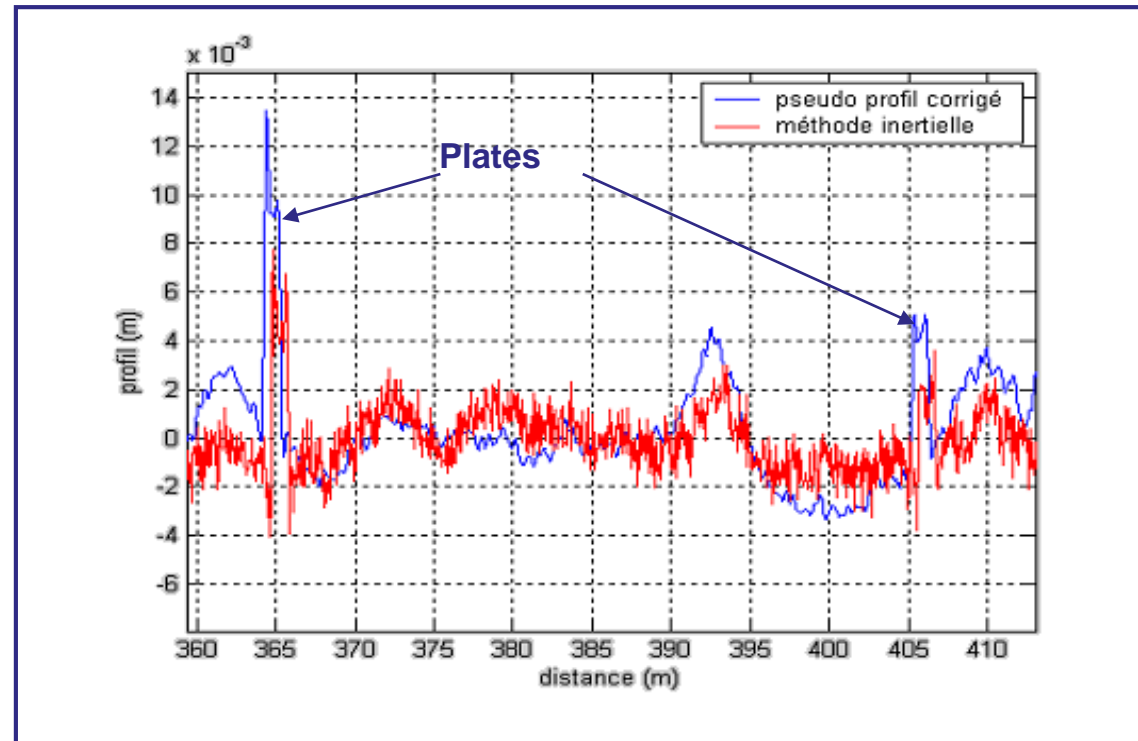

# Road adhesion

The road adhesion depends on the characteristics of the tire (type, quality, wear, inflation pressure, temperature) and the condition of the road (wet, dry, ice ..)

$\mu \Rightarrow 0$       The road is icy

$\mu \Rightarrow 0.3$       The road is sliding

$\mu \Rightarrow 0.6$       The road is wet

$\mu \Rightarrow 1$       The adhesion is maximum and the tire / ground contact is considered excellent

*Inadequate skid resistance will lead to higher risks of accidents*



The transversal friction coefficient (CFT) of the road surface is measured by the Sideway Force Coefficient Routine Investigation Machine (SCRIM\*)

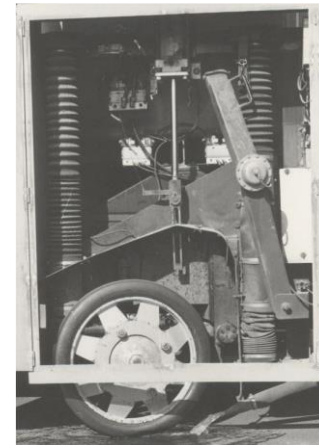

Continuous measurement of a CFT with:

- a step of 10 m
- a speed of 60 km/h

\*Certu - *Instruction sur les conditions techniques d'aménagement des voies rapides urbaines (ICTAVRU)*, 1991.

# Vehicle modeling

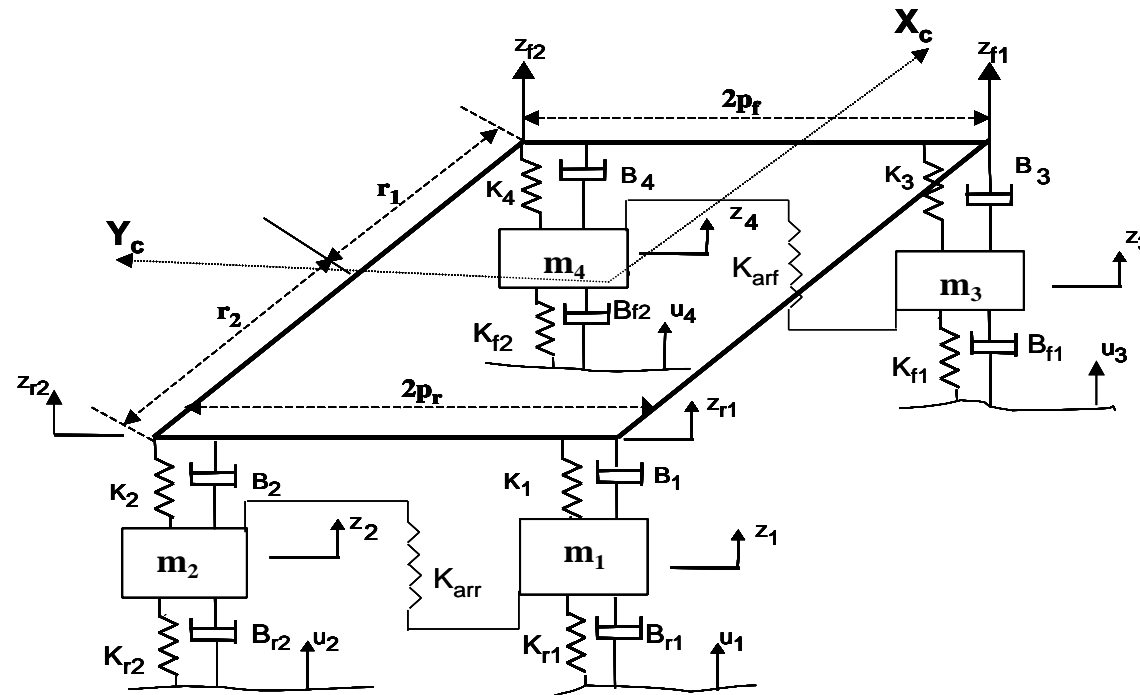
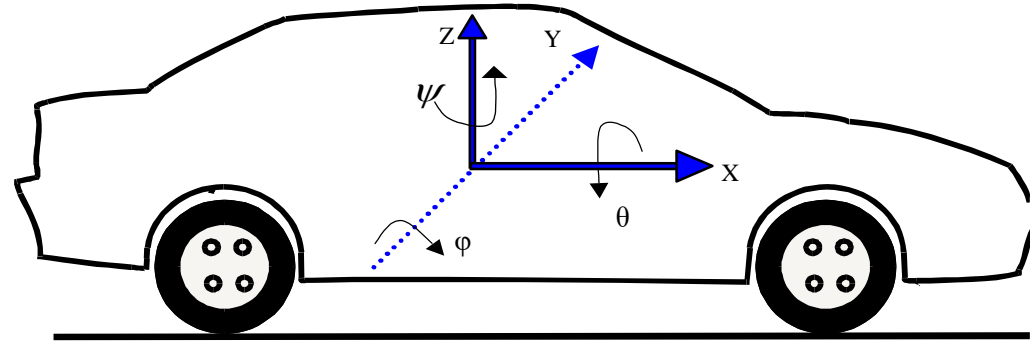

# Vehicle model

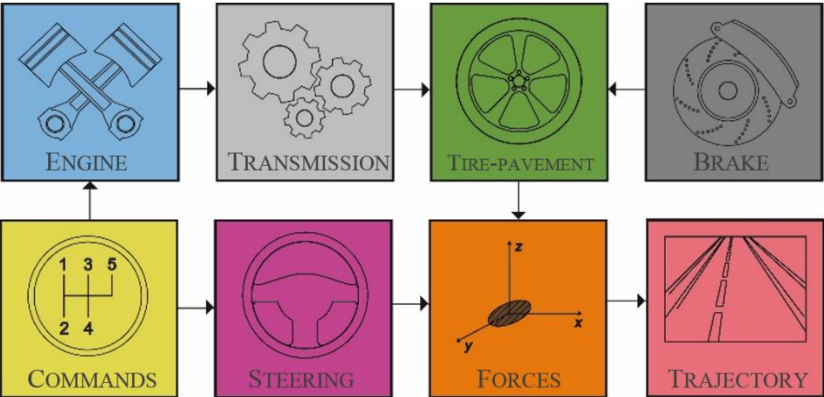
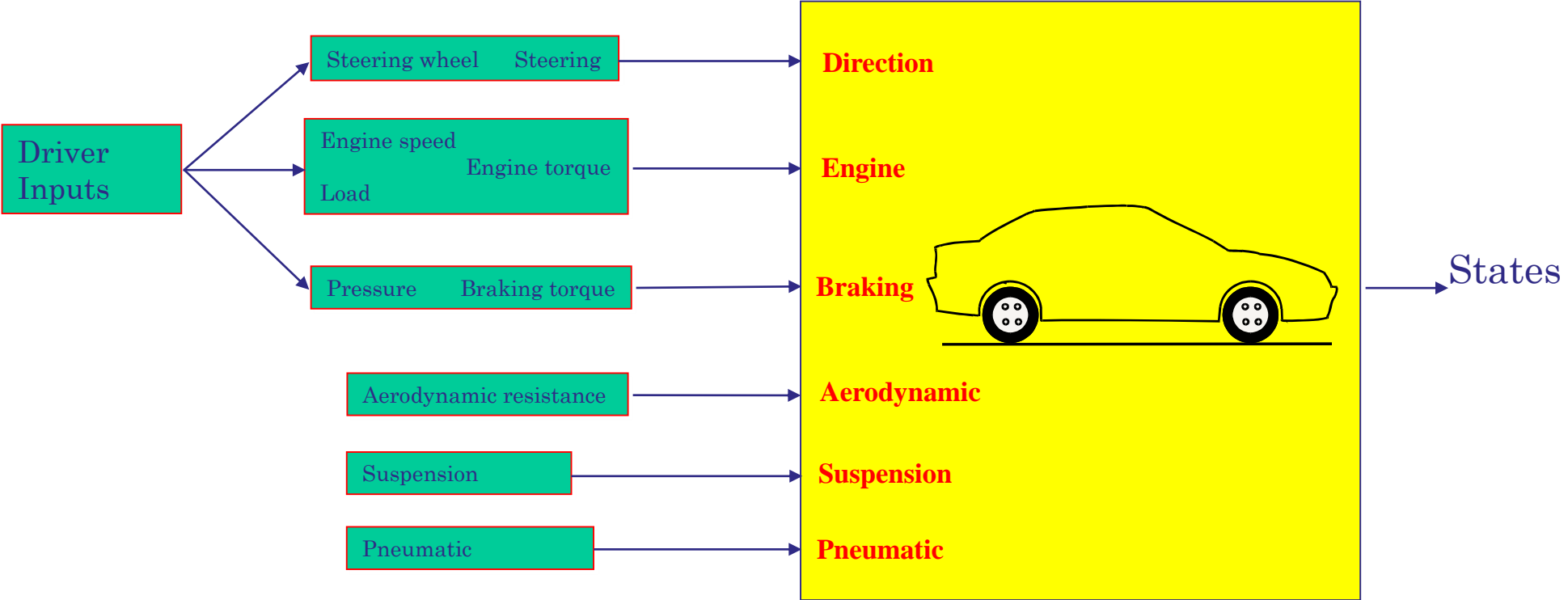

# Steering wheel

The angle at the steering wheel is usually measured

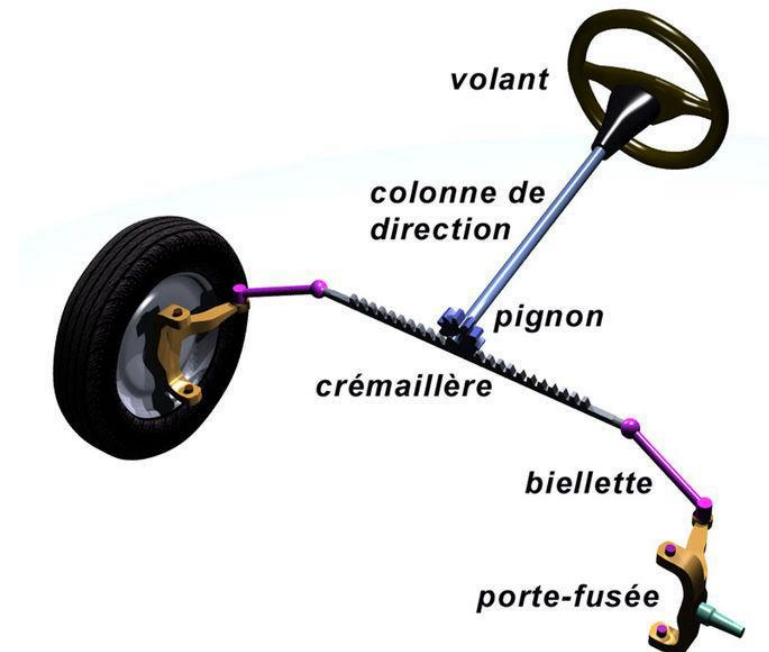

# Engine torque

In order to obtain the engine torque, the engine field map is used.



Peugeot 406, type de moteur : Essence

Régime (tr/min)						Charge (%)						corr.	Servit.
	0.0	1.5	22.0	36.0	41.0	50.0	60.0	70.0	80.0	90.0	100.0		
200	0.0	2.00	5.50	6.40	8.60	9.40	9.60	9.80	10.00	9.50	10.70	1.05	0.0
1000	0.0	1.30	5.00	6.20	8.50	9.00	9.50	9.90	10.00	10.00	10.30	1.07	0.0
1500	-1.50	1.30	4.60	6.00	7.50	9.00	9.00	9.00	9.10	9.50	10.10	1.13	0.0
2000	-3.50	2.00	4.00	6.50	7.50	9.50	10.00	10.30	10.30	10.90	11.40	1.03	0.0
3000	-4.00	1.00	4.00	7.00	7.30	9.50	11.50	12.20	11.50	13.40	13.50	0.92	0.0
4000	-4.50	0.0	3.00	4.00	5.80	7.50	9.00	9.80	10.00	12.40	13.00	0.98	0.0
5000	-5.00	-1.00	1.20	3.00	4.50	5.70	7.20	9.20	9.70	11.00	12.00	1.04	0.0
5500	-5.50	-2.00	0.0	1.80	3.20	4.00	5.40	6.10	6.70	9.00	11.00	1.02	0.0
5750	-6.00	-3.00	-2.00	0.0	1.50	2.50	3.00	3.50	5.00	7.00	9.00	1.03	0.0
correc.	1.20	1.00	0.99	1.00	1.00	1.00	1.01	1.00	1.02	1.01	1.00	1.25	1.00

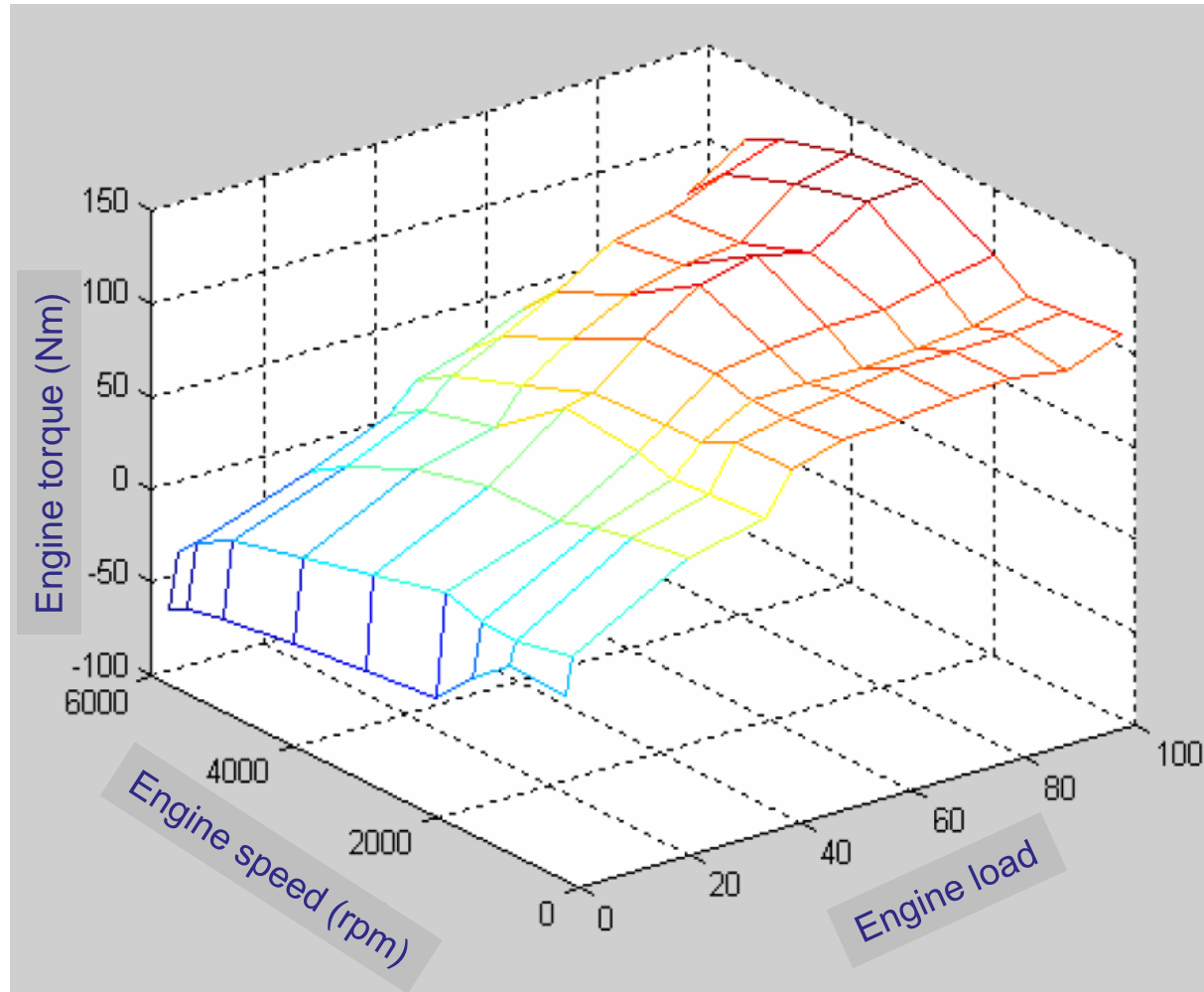

Engine map

# Braking torque

Use pressure measurements to calculate braking torques according to the table:



										Correc.
Pression (bar)	0.0	15.00	30.00	45.00	60.00	75.00	90.00	105.00	120.00	1.00
Couple train 1 gauche (m.daN)	0.0	50.00	100.00	150.00	200.00	250.00	300.00	350.00	400.00	0.57
Couple train 1 droite (m.daN)	0.0	50.00	100.00	150.00	200.00	250.00	300.00	350.00	400.00	0.65
Couple train 2 gauche (m.daN)	0.0	10.00	20.00	30.00	40.00	50.00	60.00	70.00	80.00	0.70
Couple train 2 droite (m.daN)	0.0	10.00	20.00	30.00	40.00	50.00	60.00	70.00	80.00	0.70

Braking torque related to pressure

# Dynamic chassis behavior

## 3 translation movements

- Longitudinal
- Transversal
- Vertical

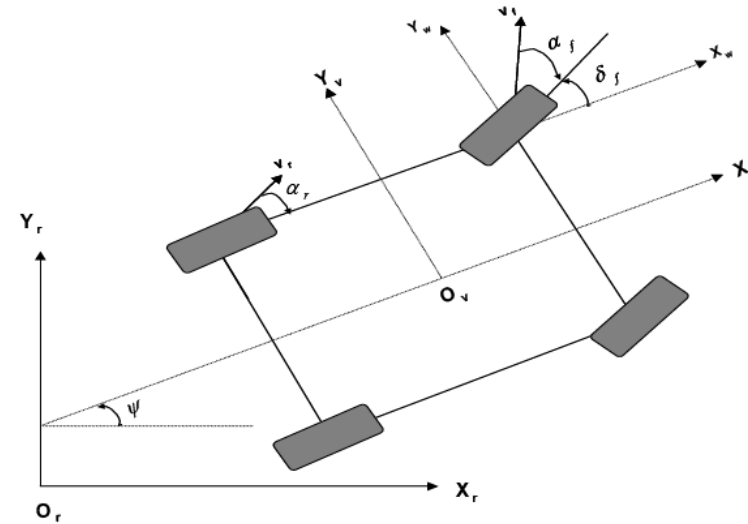

## 3 rotational movements

- Roll
- Pitch
- Yaw

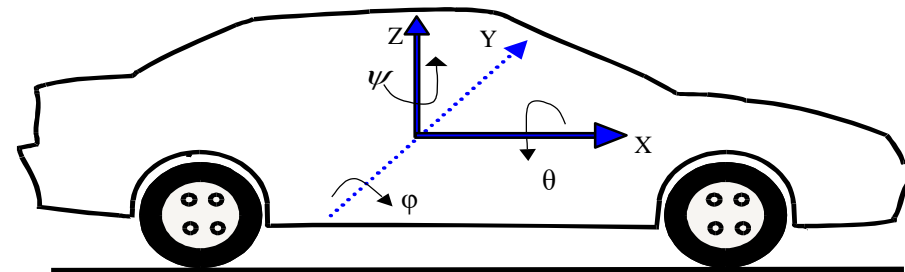



Roll

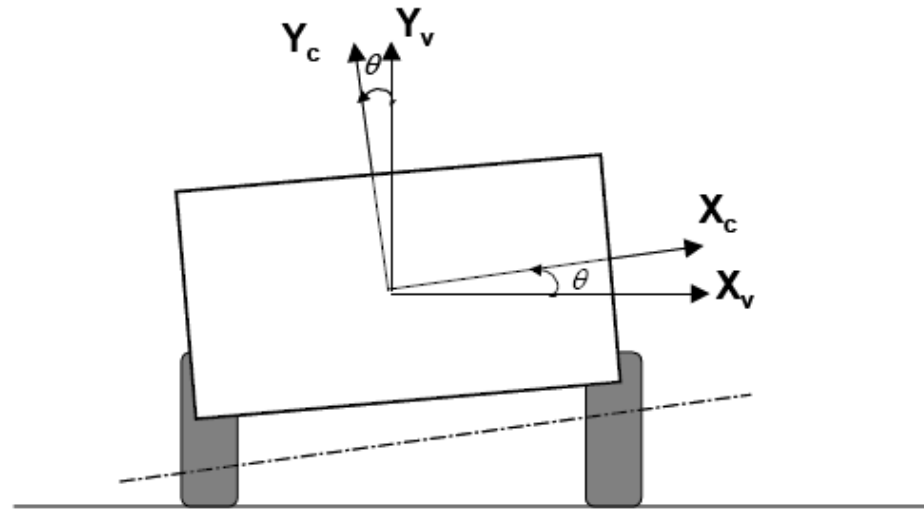

Pitch

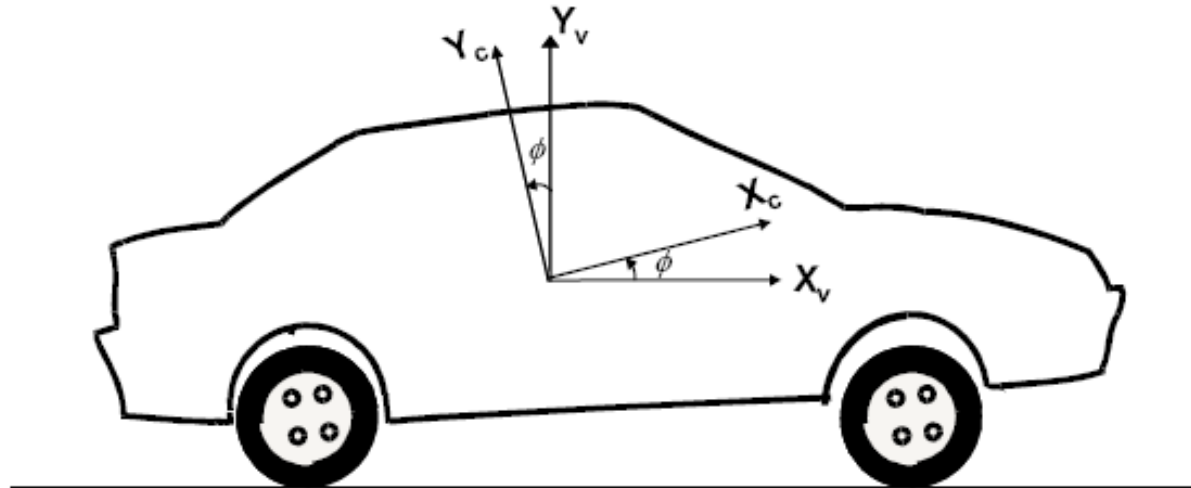

$$m \begin{bmatrix} \dot{v}_x \\ \dot{v}_y \\ \dot{v}_z \end{bmatrix} = T_r \begin{bmatrix} F_{xf1} + F_{xf2} + F_{xr1} + F_{xr2} \\ F_{yf1} + F_{yf2} + F_{yr1} + F_{yr2} \\ F_{zf1} + F_{zf2} + F_{zr1} + F_{zr2} \end{bmatrix}$$

$$T_r = \begin{bmatrix} \cos \theta \cos \psi & \sin \theta \sin \phi \cos \psi & \cos \theta \sin \phi \cos \psi + \sin \theta \sin \phi \\ \cos \phi \cos \psi & \sin \theta \sin \phi \sin \psi + \cos \theta \cos \psi & \cos \theta \sin \theta \sin \phi - \sin \theta \cos \psi \\ -\sin \psi & \sin \theta \cos \phi & \cos \theta \cos \phi \end{bmatrix}$$

$$J \begin{bmatrix} \ddot{\theta} \\ \ddot{\phi} \\ \ddot{\psi} \end{bmatrix} = \begin{bmatrix} (F_{zf1} - F_{zf2})p_f + (F_{zr1} - F_{zr2})p_r \\ -(F_{zf1} + F_{zf2})r_1 + (F_{zr1} + F_{zr2})r_2 \\ [(F_{yf1} + F_{yf2})r_1 - (F_{yr1} + F_{yr2})r_2 + \\ (F_{xf2} - F_{xf1})p_f + (F_{xr2} - F_{xr1})p_r] \end{bmatrix}_{\mathfrak{R}_C}$$

# Suspension modeling

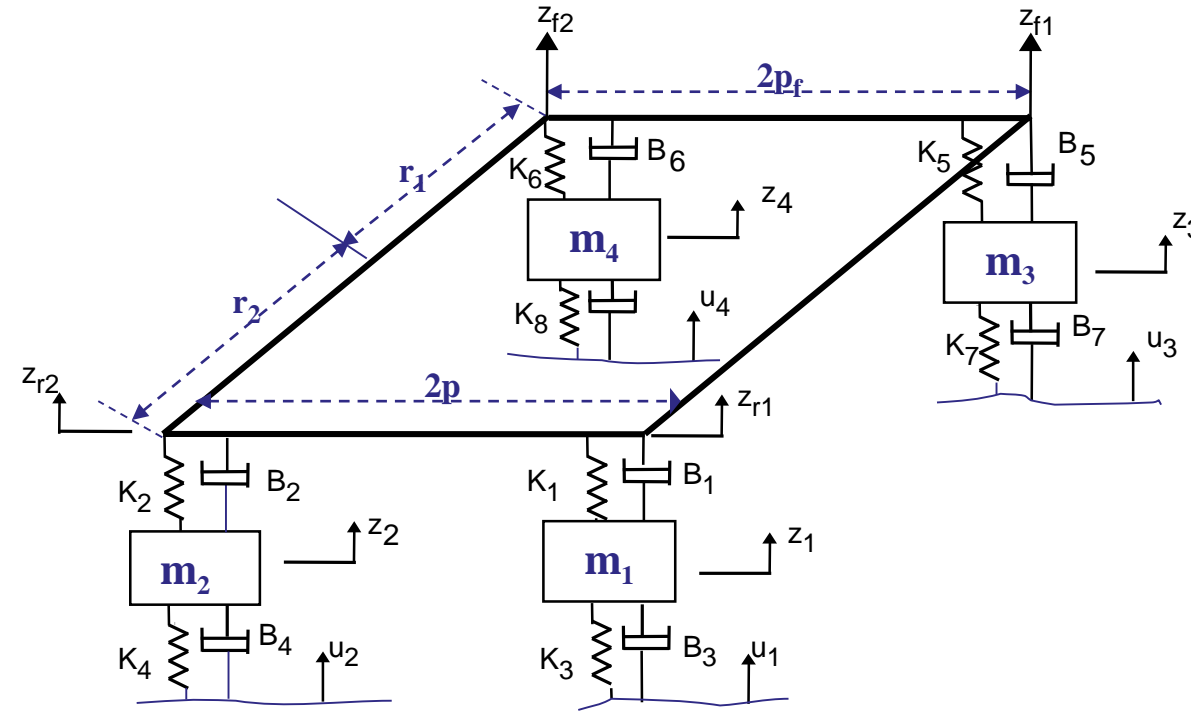

$$\ddot{z}_i = \frac{1}{m_i} (-F_{kri} - F_{cri} + k_{ri}(u_i - z_i) + B_{ri}(\dot{u}_i - \dot{z}_i))$$

# Dynamic behavior of the tire

The resulting force and torque under each wheel depends on:

- the mechanical properties of the tires,
- surface texture (microtexture and pavement macrottexture),
- local deformations of the megatexture domain,
- the operating conditions.

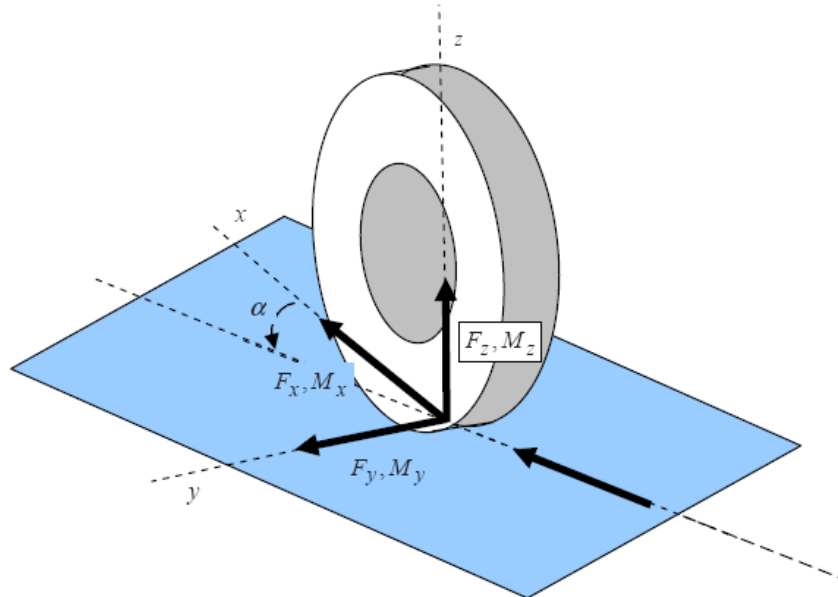

$F_x$  : longitudinal force  
 $F_y$  : transverse force  
 $F_z$  : normal force (vertical)

## Wheel road vertical modeling

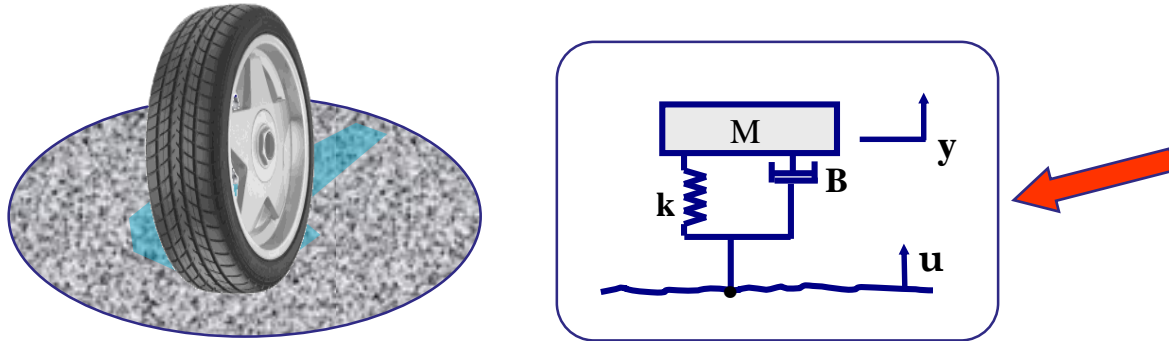

$$\begin{cases} F_{zri} = k_{ri}(z_{ri} - u_i) + B_{ri}(\dot{z}_{ri} - \dot{u}_i) ; & i = 1, 2 \\ F_{zfi} = k_{fi}(z_{fi} - u_j) + B_{fi}(\dot{z}_{fi} - \dot{u}_j) ; & j = 3, 4 \end{cases}$$

# Longitudinal modeling

$$f_{xi} = \mu f_{ni}, i = 1..4$$

$f_{xi}$  Longitudinal force

$f_{ni}$  Normal force

$\mu$  Road adhesion coefficient

**Longitudinal Force in function  
of  $f_n$  at given Velocity**

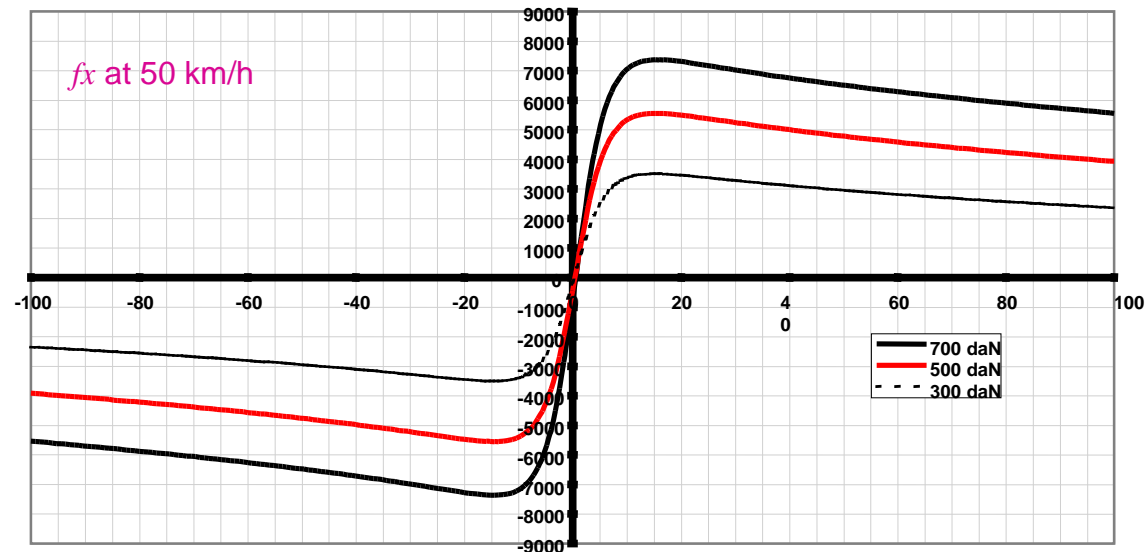

In the acceleration or braking phases, a driving or braking torque is applied to the tire → a longitudinal force is generated at the contact surface.

The relative speed of the tire with respect to the ground defines a longitudinal slip.

$$\lambda = 100 \times \left| \frac{v_x - rw}{\max(v_x, rw)} \right|$$

$$\left\{ \begin{array}{l} \lambda = \frac{rw}{v_x} - 1 \text{ si } v_x > rw \Rightarrow \text{braking} \\ \lambda = 1 - \frac{rw}{v_x} \text{ si } v_x < rw \Rightarrow \text{acceleration} \end{array} \right.$$

$v_x$  : Vehicle speed

$rw$  : Wheel speed

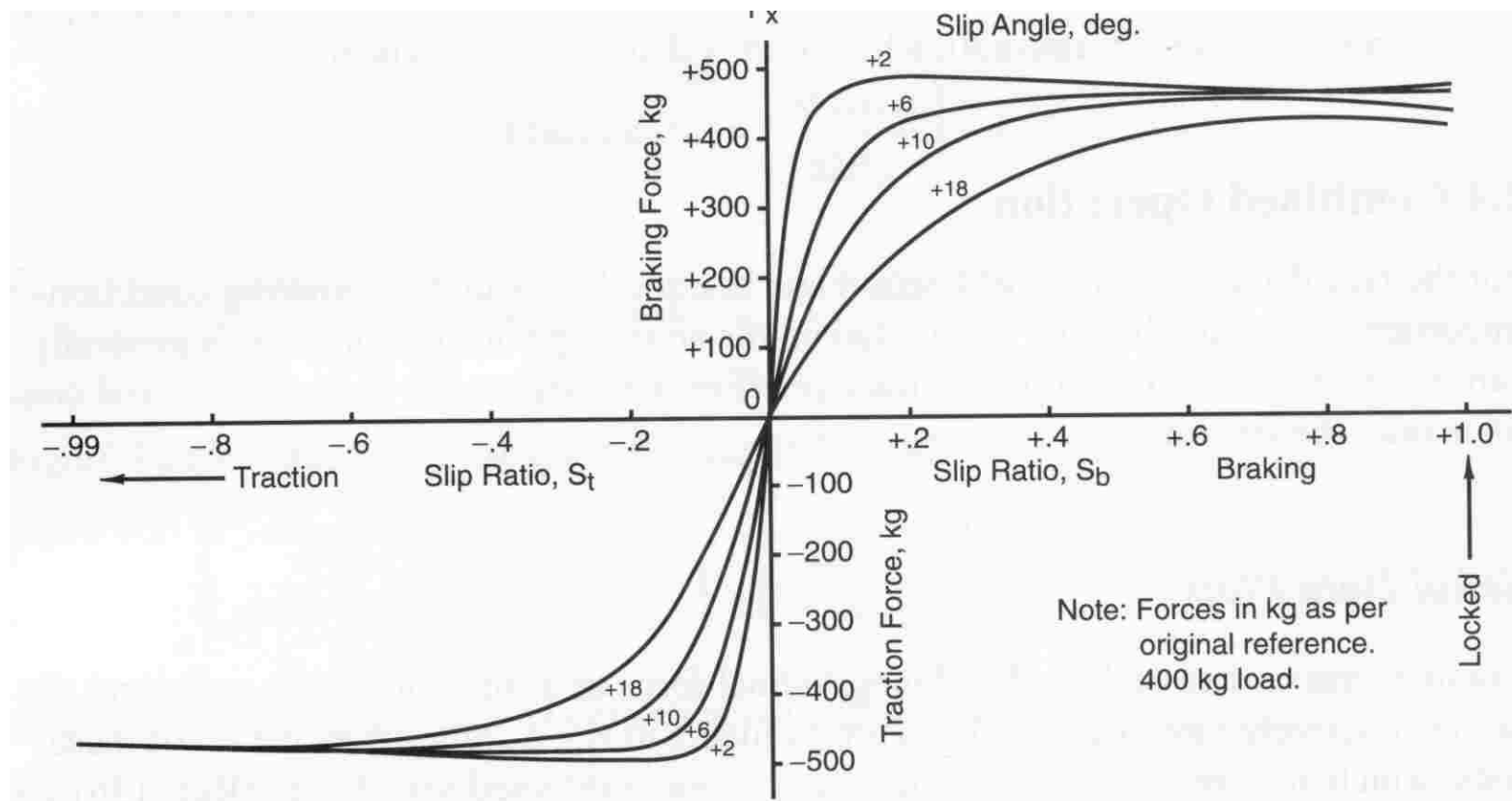



# Lateral modelling

$$\text{Pseudo sliding} \Rightarrow \begin{cases} F_{yf} = C_y \alpha_f \\ F_{yr} = C_y \alpha_r \end{cases}$$

$F_y$  : Lateral force

$\alpha_{f,r}$  : Slip angle

$C_y$  : Stiffness coefficient

$\delta_f$  : Side slip angle

$\dot{\psi}$  : Yaw speed

$$\begin{cases} \alpha_f = \delta_f - \beta - \dot{\psi} r_1 / v \\ \alpha_r = -\beta - \dot{\psi} r_2 / v \end{cases}$$

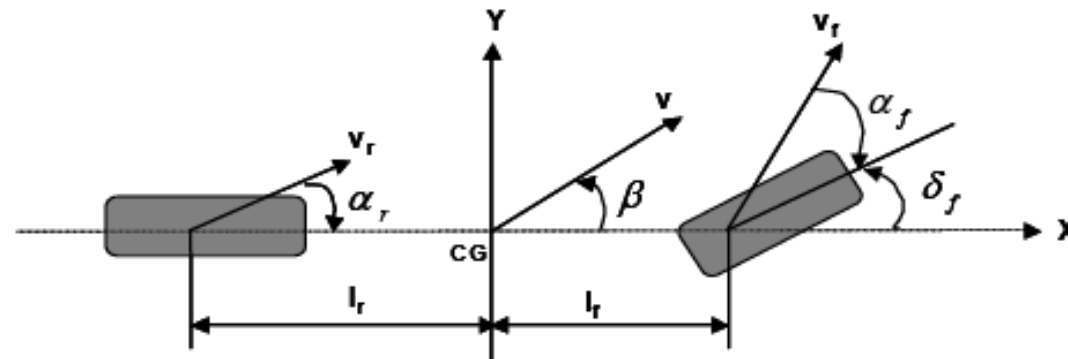

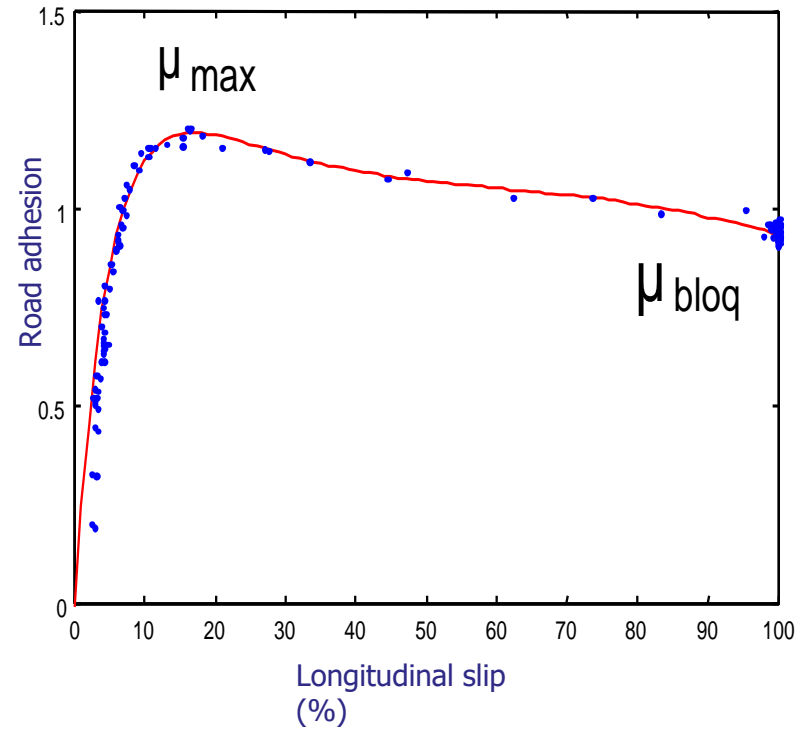
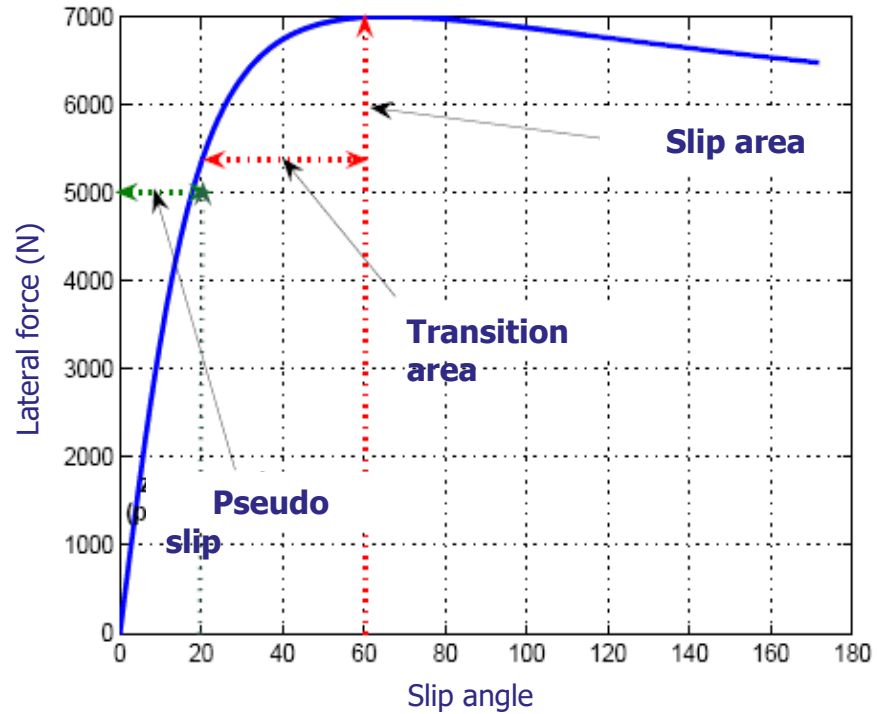

In the case of small slip angles (pseudo slip area) :

$$\mu = C_1(1 - e^{-C_2\lambda}) - C_3\lambda \quad (\text{Burckhardt Model*})$$

In case of higher slip angles, the behavior of the tire is often described by empirical formula proposed by Bakker and Pacejka\*:

$$Y(X) = y(x) + S_v$$

$$y(x) = D \sin(C \arctan(Bx - E(Bx - \arctan(Bx))))$$

$$x = X + S_h$$

Y and X → longitudinal force and longitudinal slip  
Or lateral force and slip angle

Other models of:

- Kiencke and Daiss
- Lugre
- Dugoff
- Guo
- Brosse and Gim

\* H. Pacejka & E. Bakker. *The magic Formula Tyre Model*. In *Proceedings, 1st International Colloq on Tyre models for vehicle dynamics analysis*, pp. 1-18, 1991.

# Wheel's rotational movement

$$J\dot{w} = \tau - rF_x$$

$w$  : Speed of wheel

$\tau$  : Engine torque

$F_x$  : Longitudinal force

$r$  : Radius of wheel

$J$  : Inertia of wheel

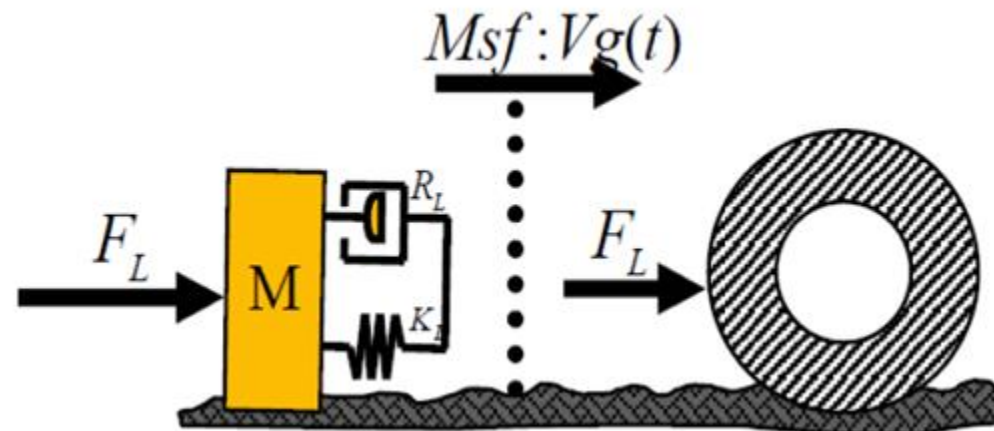
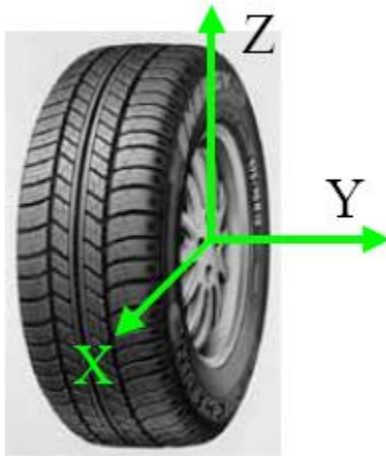

# Model simulation

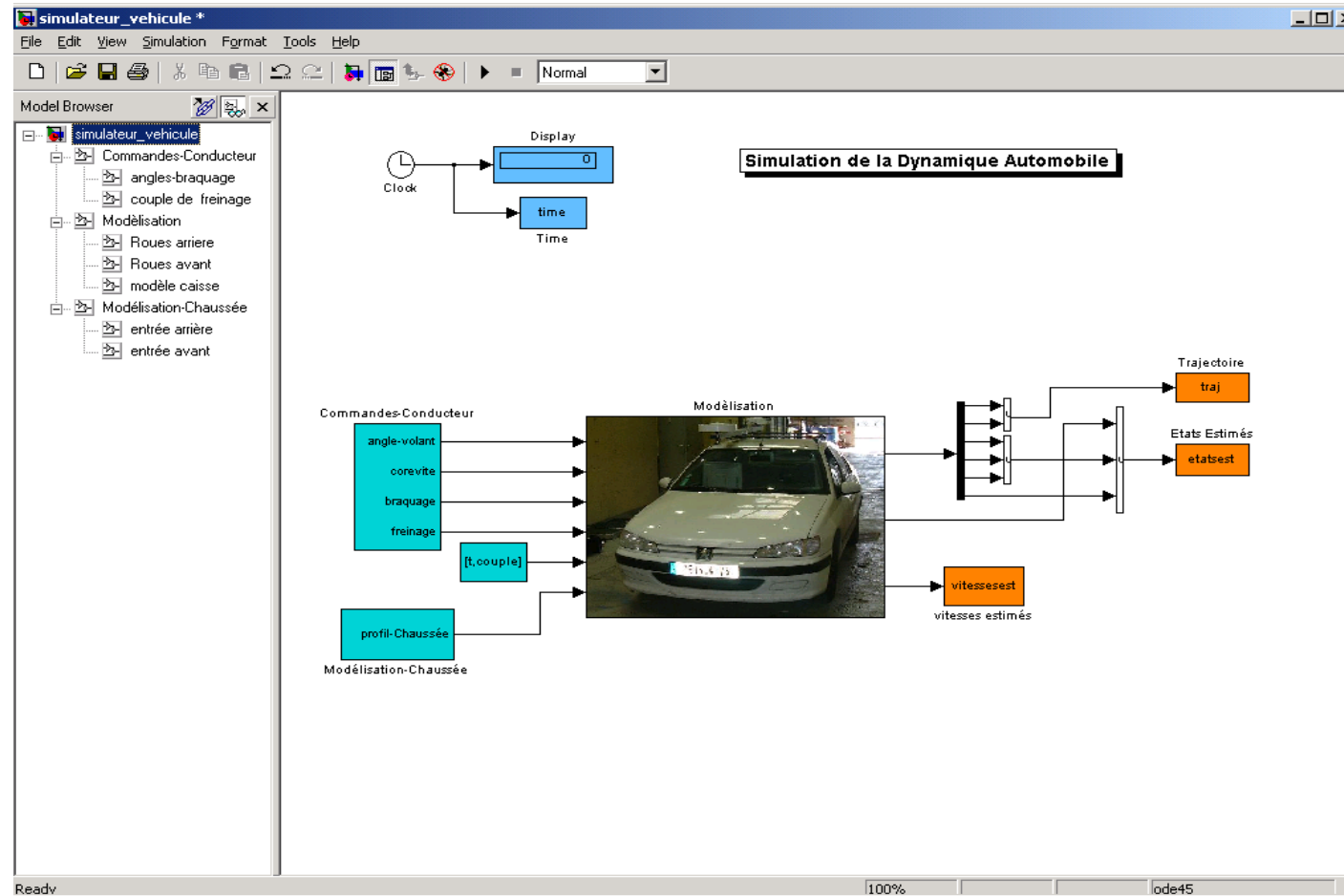

# *Experimentation*

The vehicle is equipped with 39 sensors at a spatial frequency of 5 cm, in order to validate the developed models



# Control sensors

- Steering wheel control
- Brake control (brake pressure)
- Throttle control (throttle opening)
- Gearbox control
- Handbrake control
- Clutch control







- Vertical, transverse and longitudinal accelerometers
- Vertical wheels accelerometers
- Vertical, transverse and longitudinal gyrometers (roll, pitch and yaw)
- Suspension displacements sensors



Accelerometers and gyrometers box

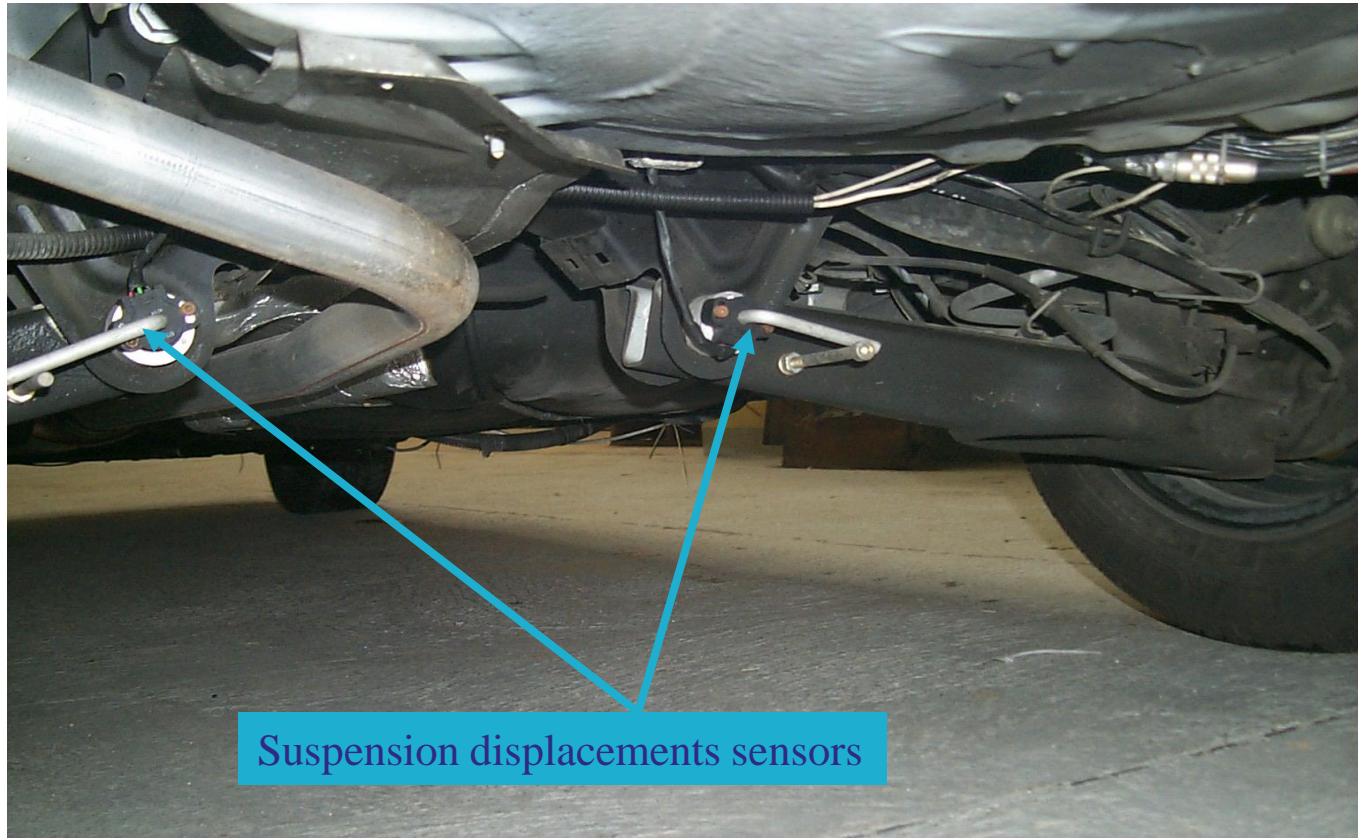

Suspension displacements sensors





GPS



# Validation

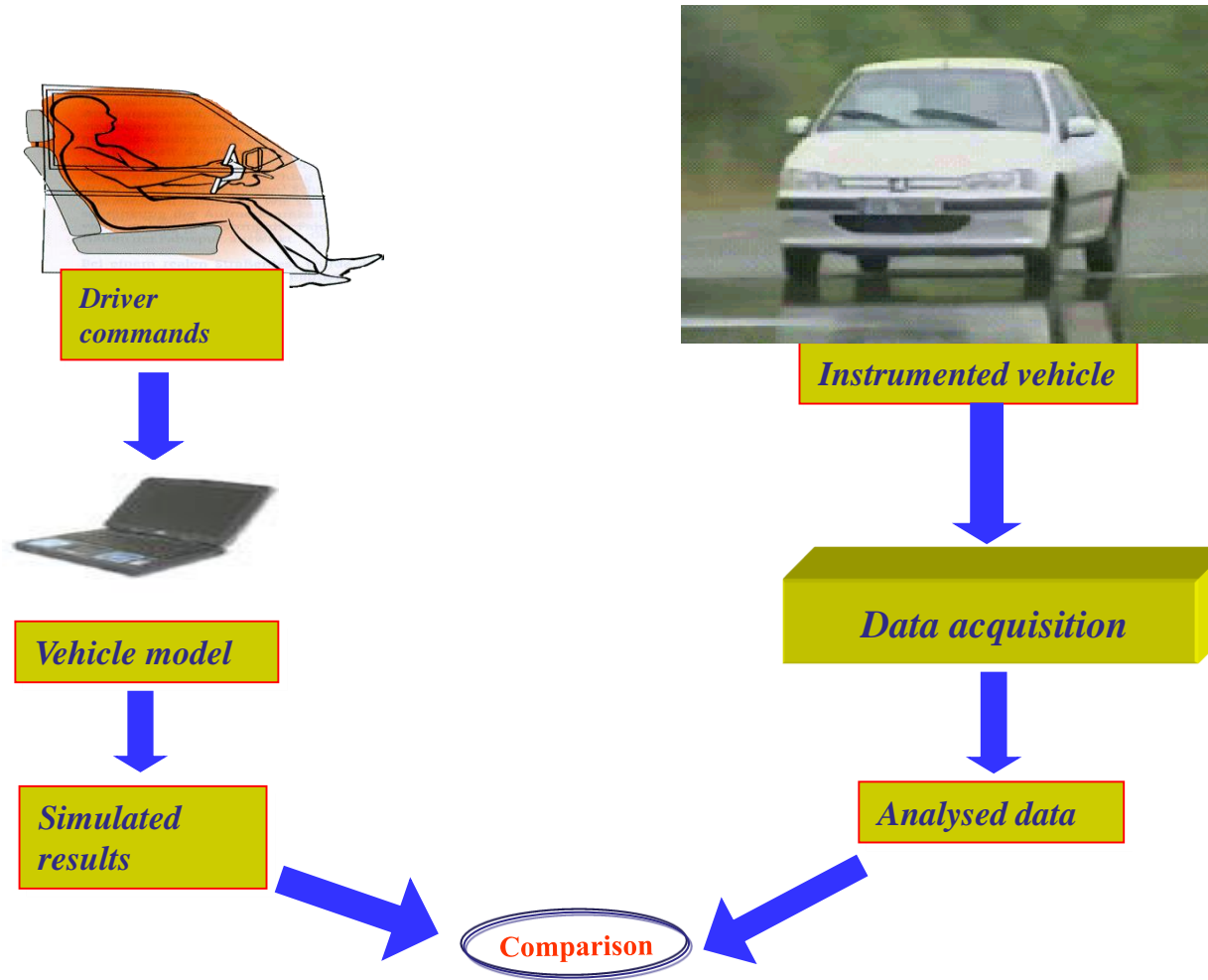



# Validation results

## Vertical displacements of wheels

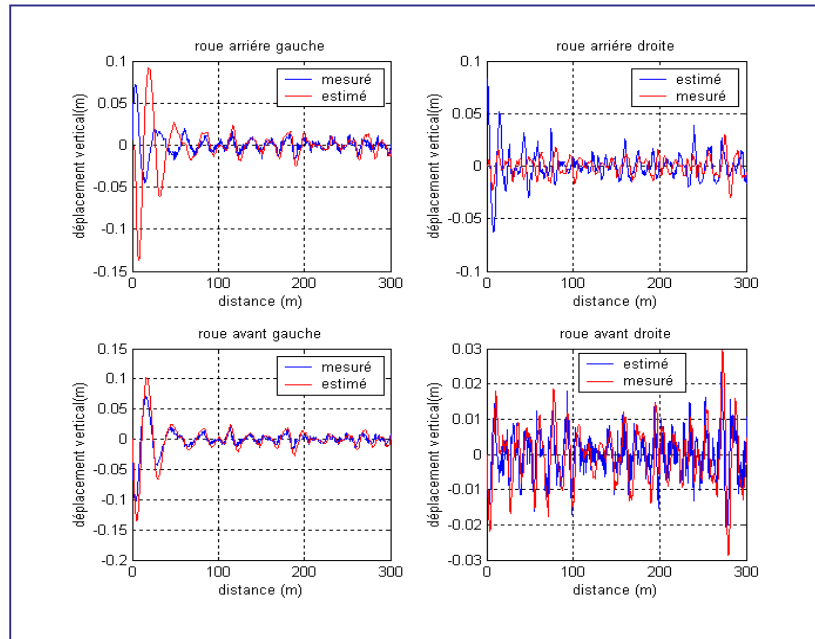

## Wheels speeds

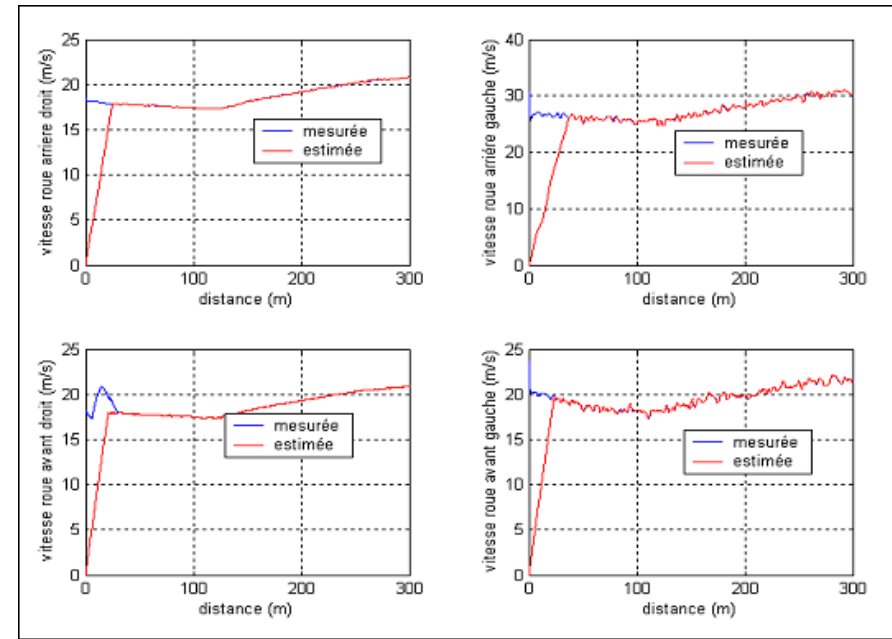

## Vertical displacements of chassis

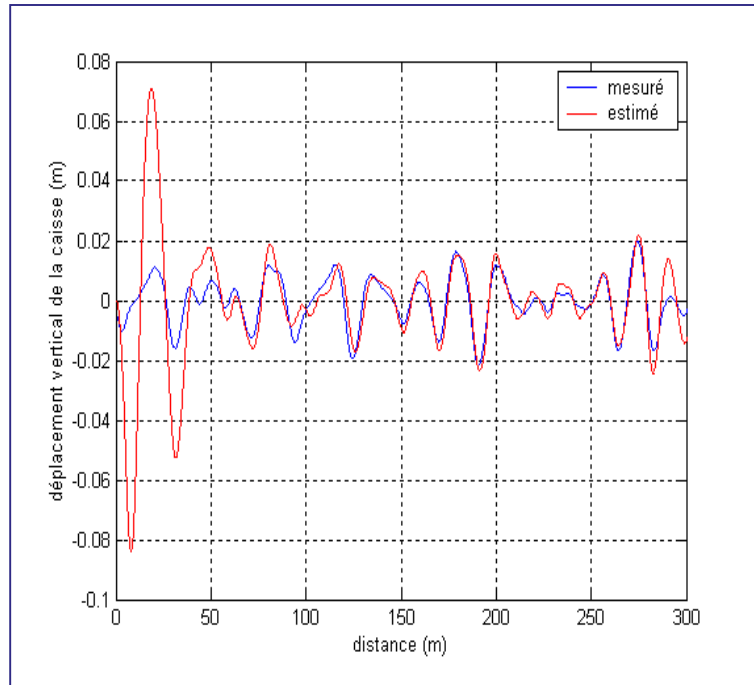

## Vertical acceleration of chassis

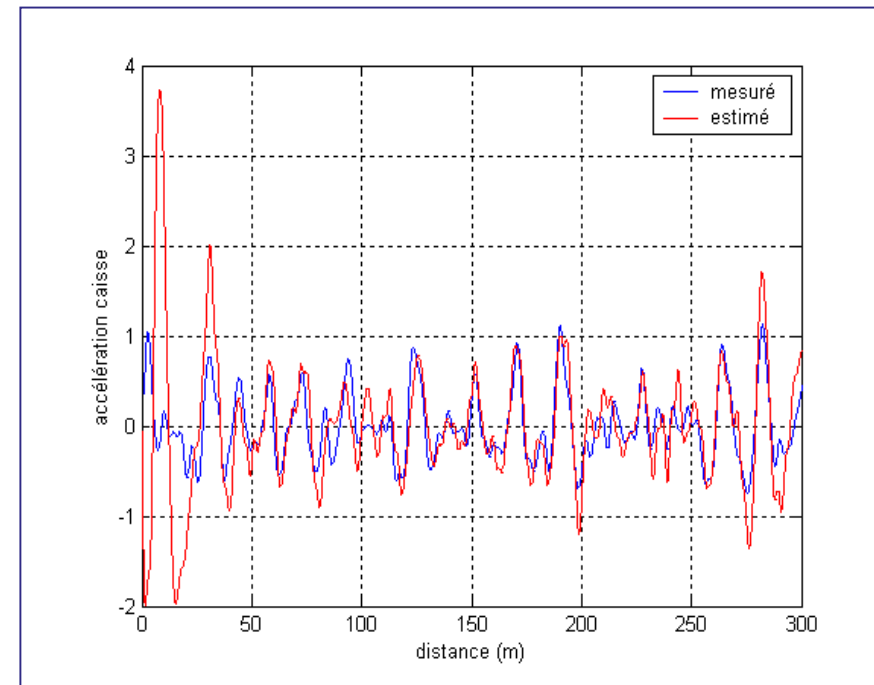

## Impact forces identification

→ Estimate on-board the tyre forces for monitoring the behavior of the vehicle and to control the load.

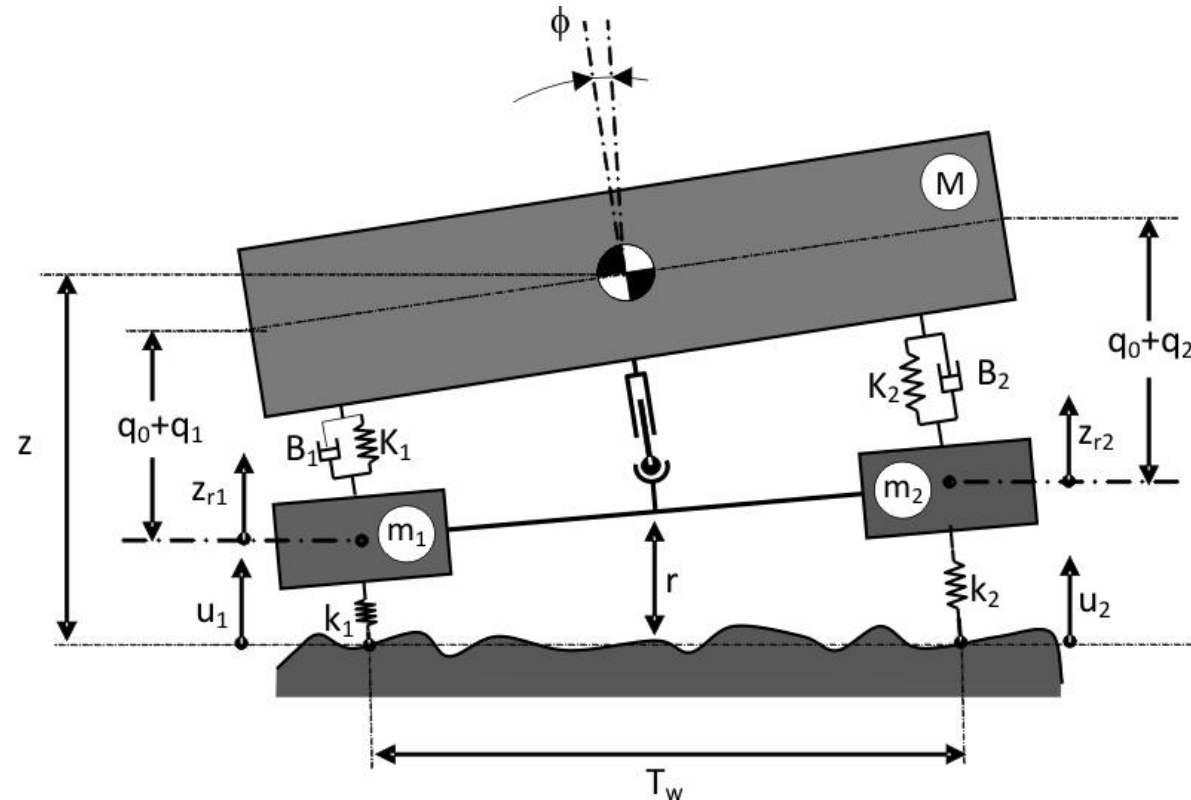

**→ Developing a precise and low-cost system for on-board evaluation of vertical forces**

### **Main objectives**

- Improving the road safety (rollover avoidance).**
- Protecting infrastructure by stabilizing the variations of vertical forces.**

## State of the art

The mainly existing works consist of

- 1) Estimating the forces through the observation of dynamic variables of the vehicle (centre height of gravity).
  - ➔ This method involves knowing accurately the parameters of the vehicle and the pneumatic and also the road profile.
- 2) Estimating the forces by use of strain gauges in a hub
  - ➔ A precise but expensive solution and it is limited to straight constant speed maneuvers and doesn't suite to cornering maneuvers with large lateral forces.
- 3) Measuring by use of dynamo wheel sensor
  - ➔ A precise method but very expansive and not practical

# Methodology

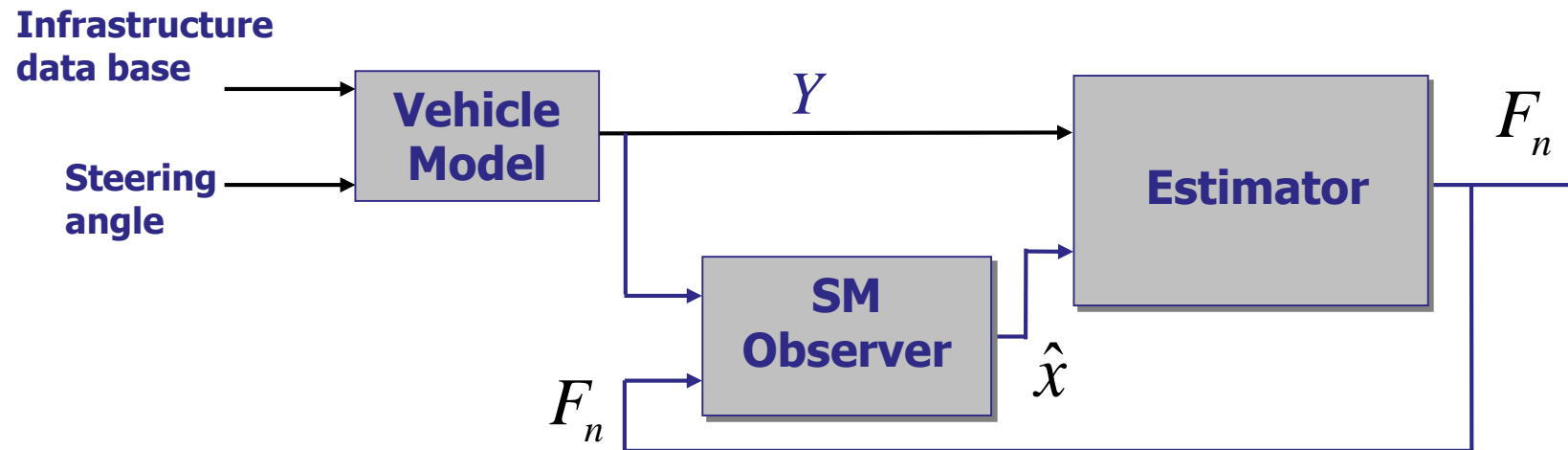

**System (S)**  
$$\begin{cases} \dot{x}_1 = x_2 \\ \dot{x}_2 = M^{-1}(F_g - C(x_1, x_2)x_2 - K(x_1)) \\ y = x_1 \end{cases}$$

$$y = q = [q_1, q_2, q_3, q_4, \theta]$$

$y$  is the measured outputs (suspensions deflections, roll angle)

**Vertical displacements wheels**  
$$\begin{cases} z_{r1} = z - q_1 + \frac{T}{2} \sin(\theta) - r \\ z_{r2} = z - q_2 - \frac{T}{2} \sin(\theta) - r \end{cases}$$

$$z_{ri} = f(q, \dot{q}, \ddot{z}_{ri}), i = 1..4$$

**Vertical forces**  
$$F_{ni} = F_{ci} + k_i(u_i - z_{ri}), i = 1..4$$

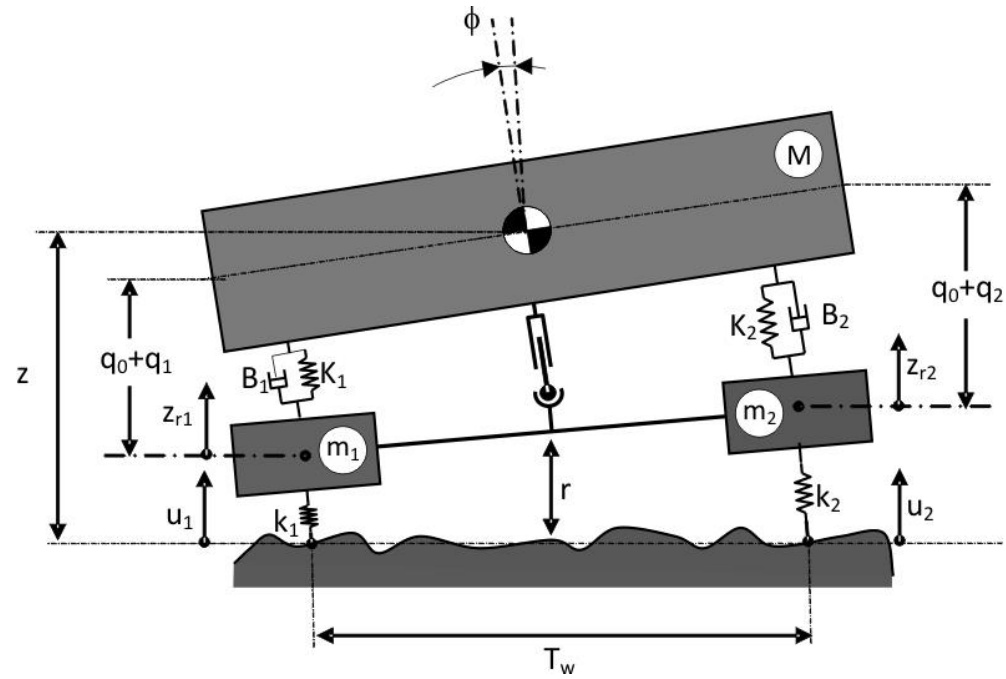

$$\left\{ \begin{array}{l} \ddot{z}_{r1} = (B_1 \dot{q}_1 + K_1 \frac{T_w}{2} \sin(\phi) + B_1 \frac{T_w}{2} \cos(\phi) \dot{\phi} \\ \quad + K_1 q_1 - k_1 z_{r1} + k_1 u_1) / m_1 \\ \ddot{z}_{r2} = (B_2 \dot{q}_2 - K_2 \frac{T_w}{2} \sin(\phi) - B_2 \frac{T_w}{2} \cos(\phi) \dot{\phi} \\ \quad + K_2 q_2 - k_2 z_{r2} + k_2 u_2) / m_2 \end{array} \right.$$

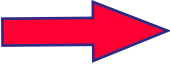

# Second order sliding mode observer

Observer  
$$\begin{cases} \dot{\hat{x}}_1 = \hat{x}_2 + Z_1 \\ \dot{\hat{x}}_2 = f(\hat{x}_1, \hat{x}_2, u) + Z_2 \end{cases}$$

$$\begin{cases} Z_1 = \lambda |\tilde{x}_1|^{1/2} \text{sign}(x_1 - \hat{x}_1) \\ Z_2 = \alpha \text{sign}(\tilde{x}_1) \end{cases} \quad \begin{cases} \tilde{x}_1 = x_1 - \hat{x}_1 \\ \tilde{x}_2 = x_2 - \hat{x}_2 \end{cases}$$

## Dynamic states errors:

$$\begin{cases} \dot{\tilde{x}}_1 = \tilde{x}_2 - Z_1 \\ \dot{\tilde{x}}_2 = F(x_1, x_2, \hat{x}_2) - Z_2 \end{cases}$$

$$F(x_1, x_2, \hat{x}_2) = f(x_1, x_2, u) - f(\hat{x}_1, \hat{x}_2, u)$$

## Convergence analysis

$$|F(x_1, x_2, \hat{x}_2)| = |f(x_1, x_2, u) - f(\hat{x}_1, \hat{x}_2, u)| < f^+$$

$$f^+ = 2\text{Max}|x_2|$$

$$\alpha > f^+$$

$$\lambda > \sqrt{\frac{2}{\alpha - f^+}} \frac{(\alpha + f^+)(1 + p)}{1 - p}; \quad 0 < p < 1$$

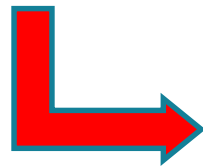

$$(\hat{x}_1, \hat{x}_2) \rightarrow (x_1, x_2)$$

$$\rightarrow \begin{cases} \dot{\tilde{x}}_1 = \tilde{x}_2 - Z_1 \rightarrow 0 \\ \dot{\tilde{x}}_2 = F(x_1, x_2, \hat{x}_2) - Z_2 \rightarrow 0 \end{cases}$$

## **Suspension deflections and speeds convergence**

**→ Convergence of vertical displacements of wheels**

**→ Estimation of vertical forces**

# Experimental results

## 1. Vehicle excited in vertical way

The instrumented vehicle



- 1. Hydraulic jack
- 2. Vehicle
- 3. LVDT sensor

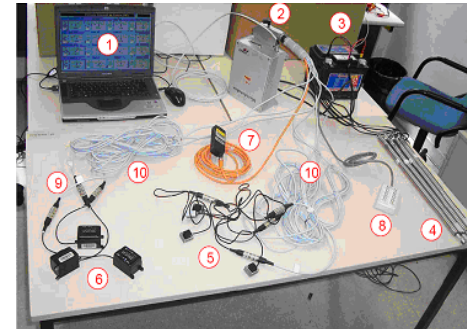

- 1. Control desk software
- 2. Micro-AutoBox
- 3. Battery
- 4. LVDT sensors
- 5. Accelerometers
- 6. Gyrometers
- 7. Laser sensor
- 8. BNC connectors



The acquisition material



The installed sensors

# Test bench



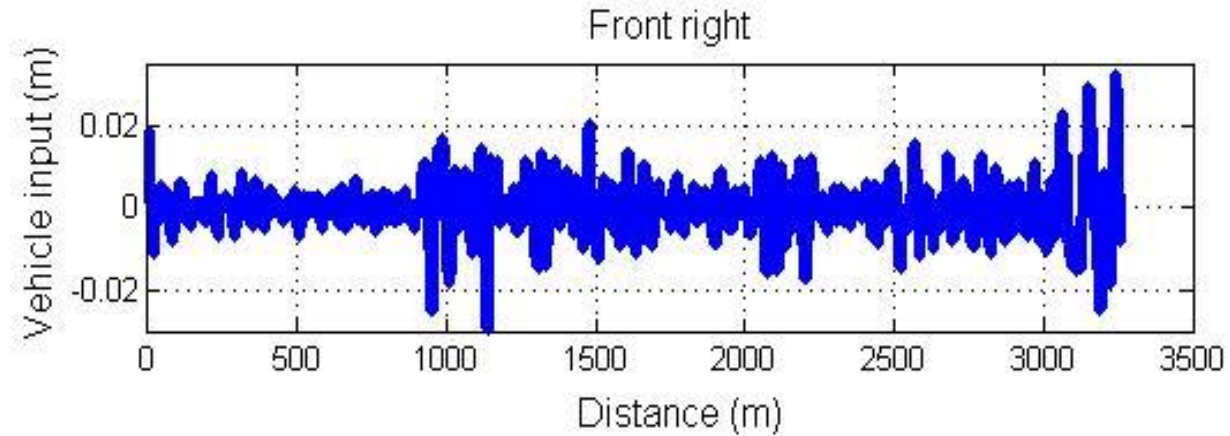
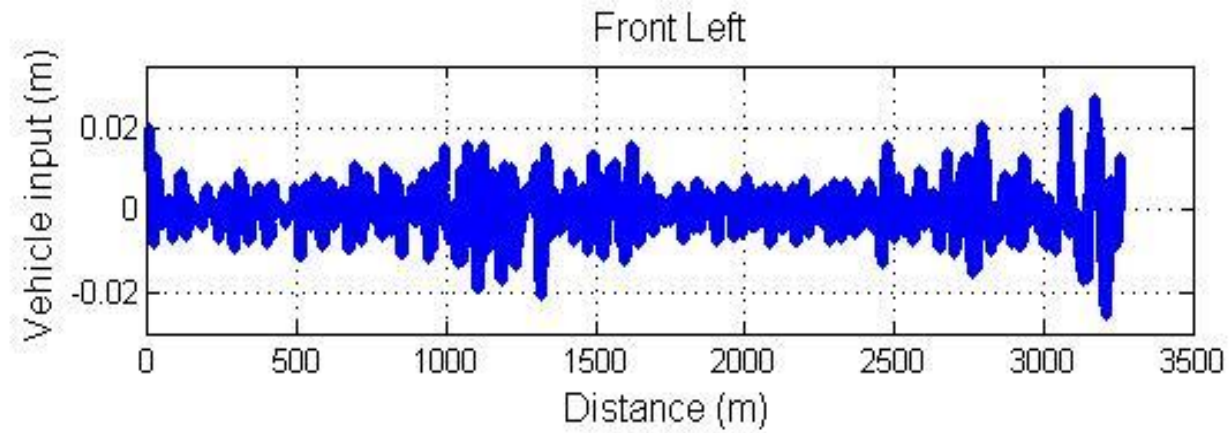

Vehicle inputs (road profile)

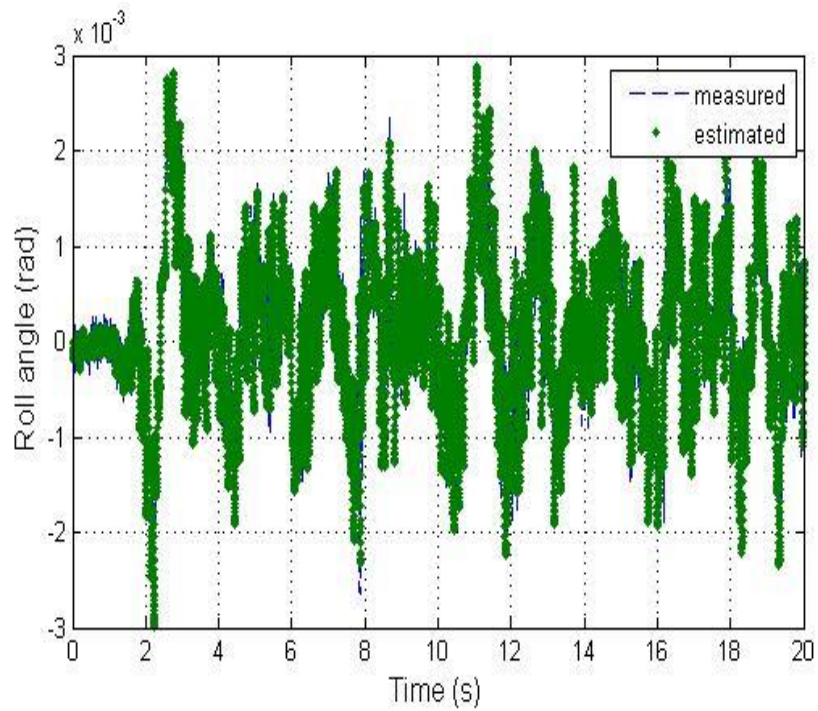

Roll angle estimation

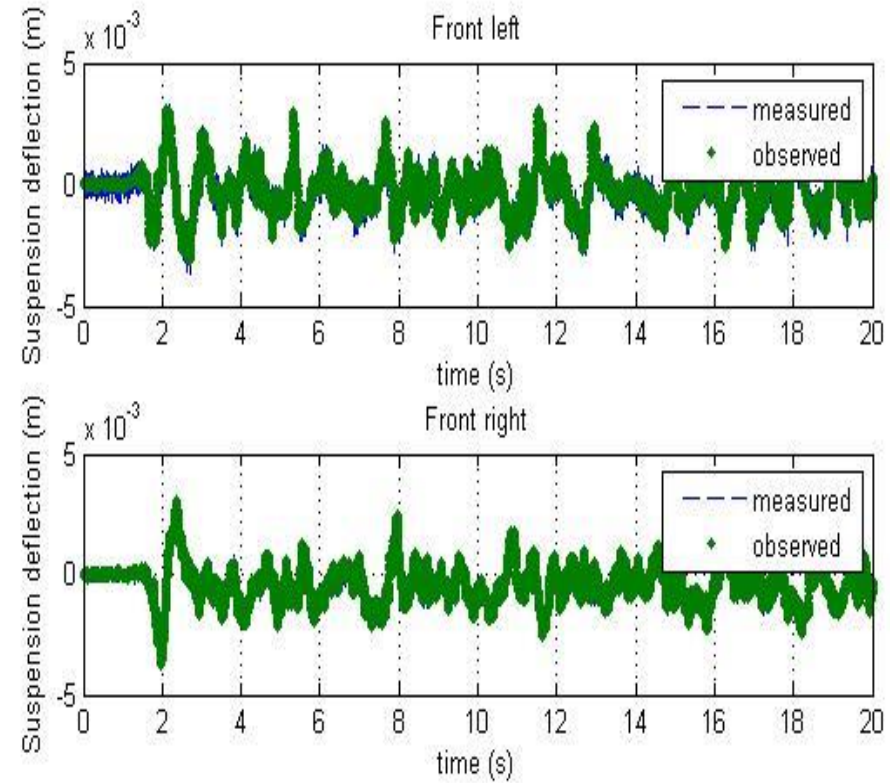

Suspension deflection estimation

### Front left wheel

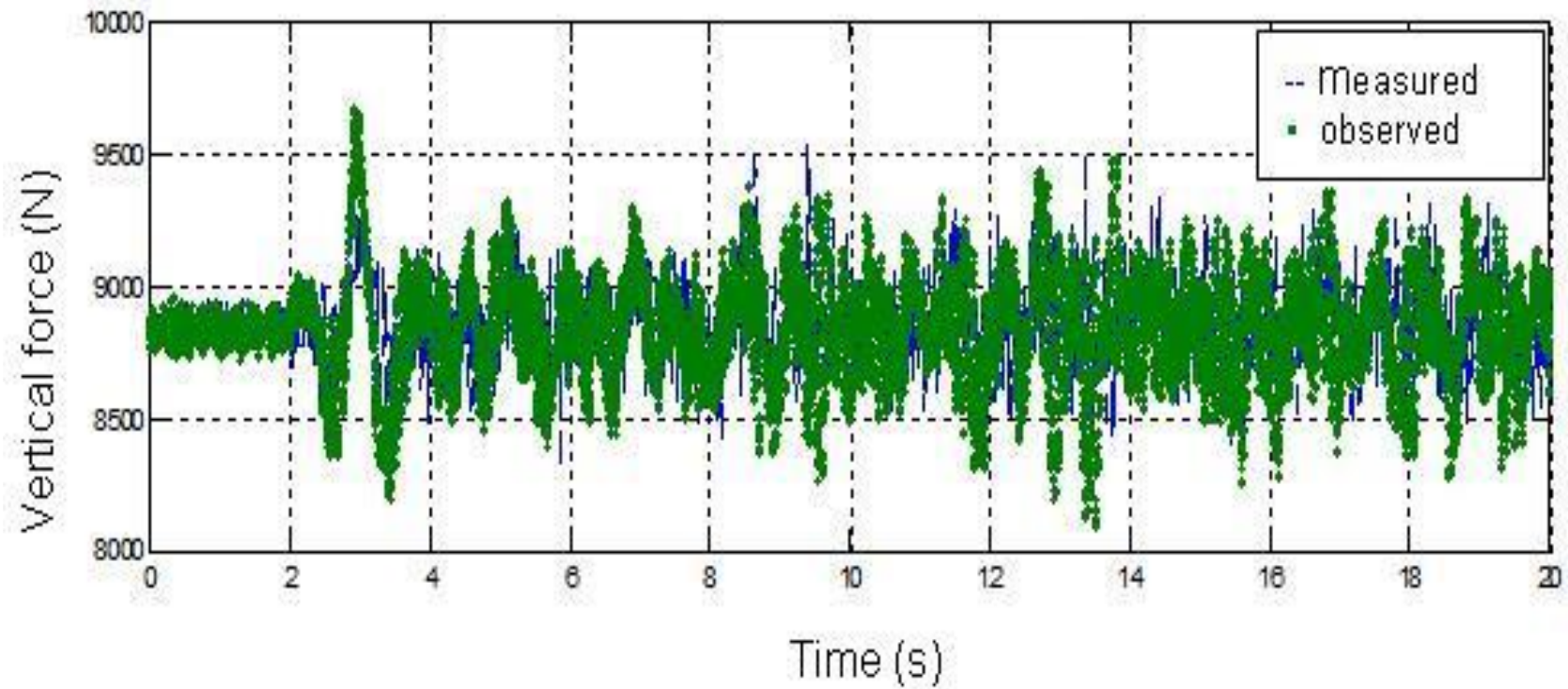

Impact force estimation



## 2. Experiments with ALF

- Test the estimation algorithm using the ALF (Accelerated Load Facility)
- Sensors are fitted to the ALF: LVDT, APT and Accelerometers



Real road profile (french national road) – 40 T static load

# HEAVY VEHICLE RISKS STUDY

## *Rollover simulation*

*Speed limit respected (30km/h)*



# ***Rollover simulation***

***Speed limit not respected (45km/h)***



# ***Rollover simulation***

## ***Load Transfert***



# Rollover risk prediction system

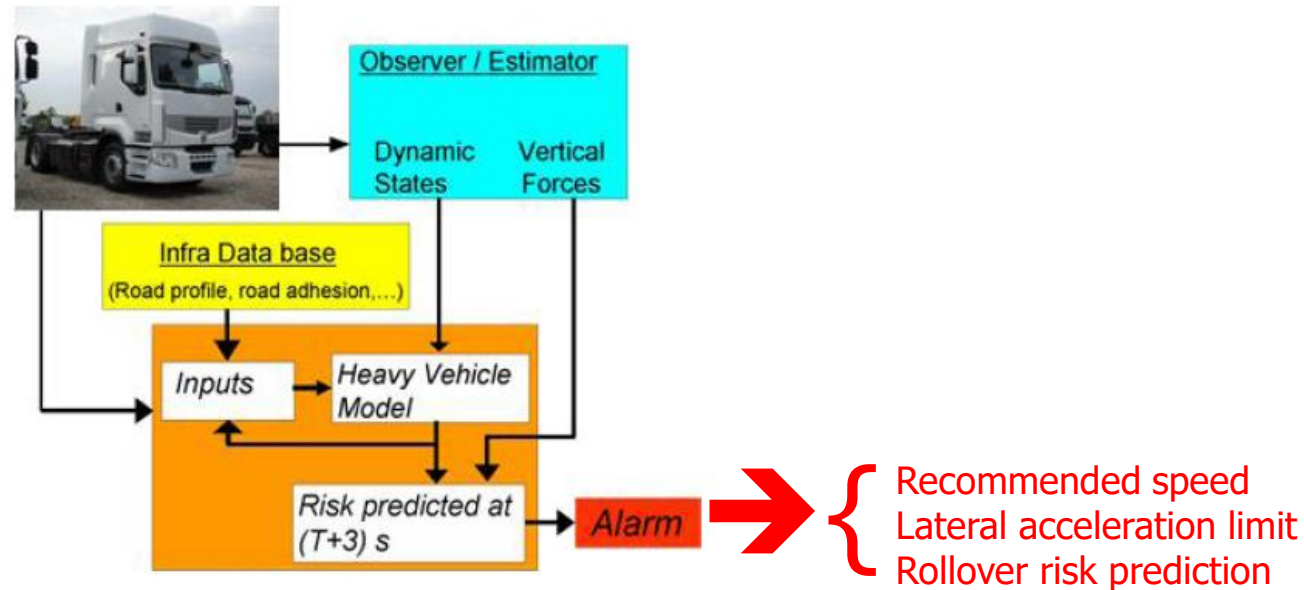

The rollover is predicted at  $(t+3)s$  using

- Infrastructure data base (radius, slops, road adhesion, road profile)
- Measures from sensors
- Estimated vertical forces
- Estimated states

## *Load Transfert*

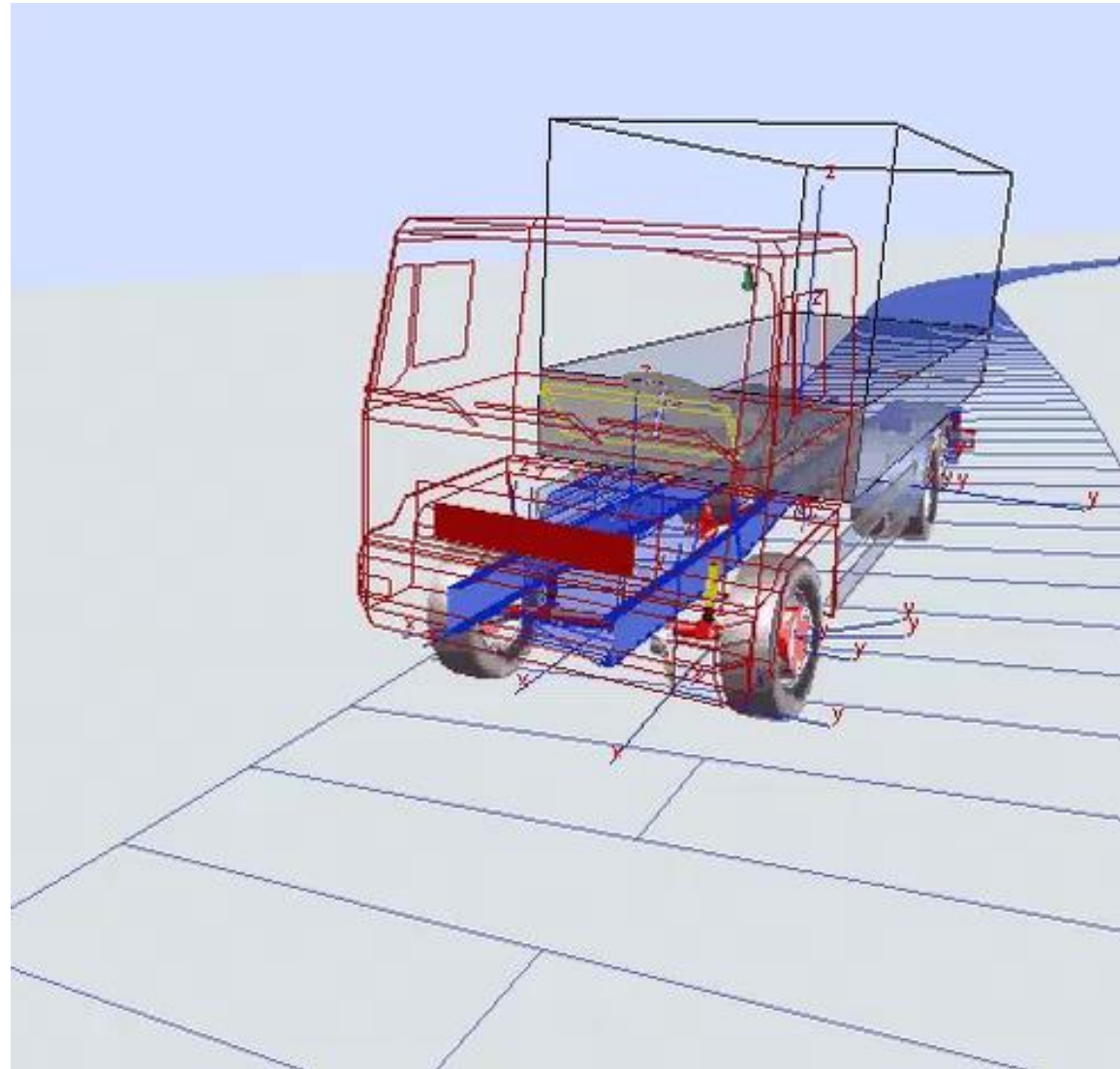

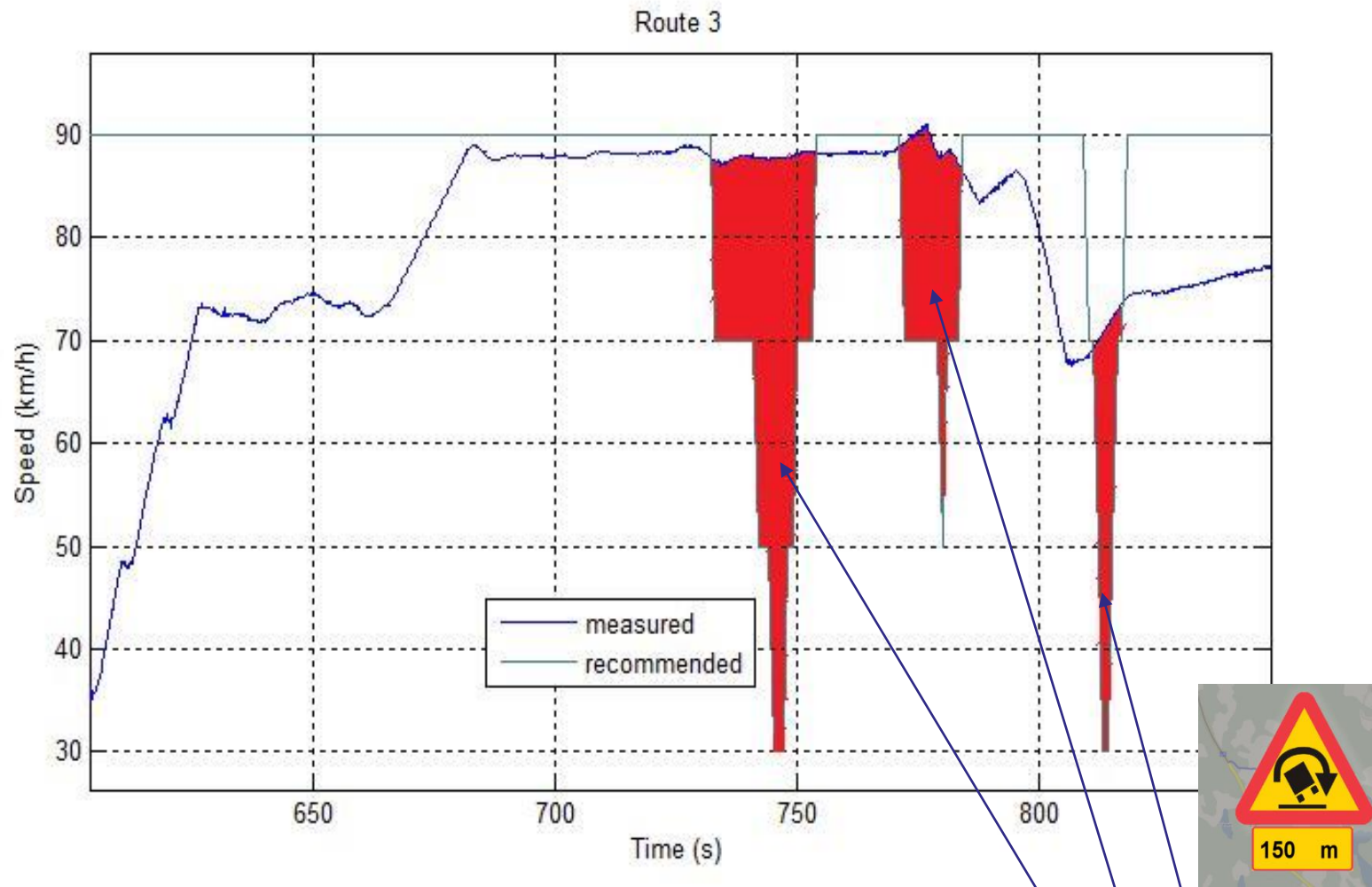

**Rollover risk area**

# *Rollover simulation*

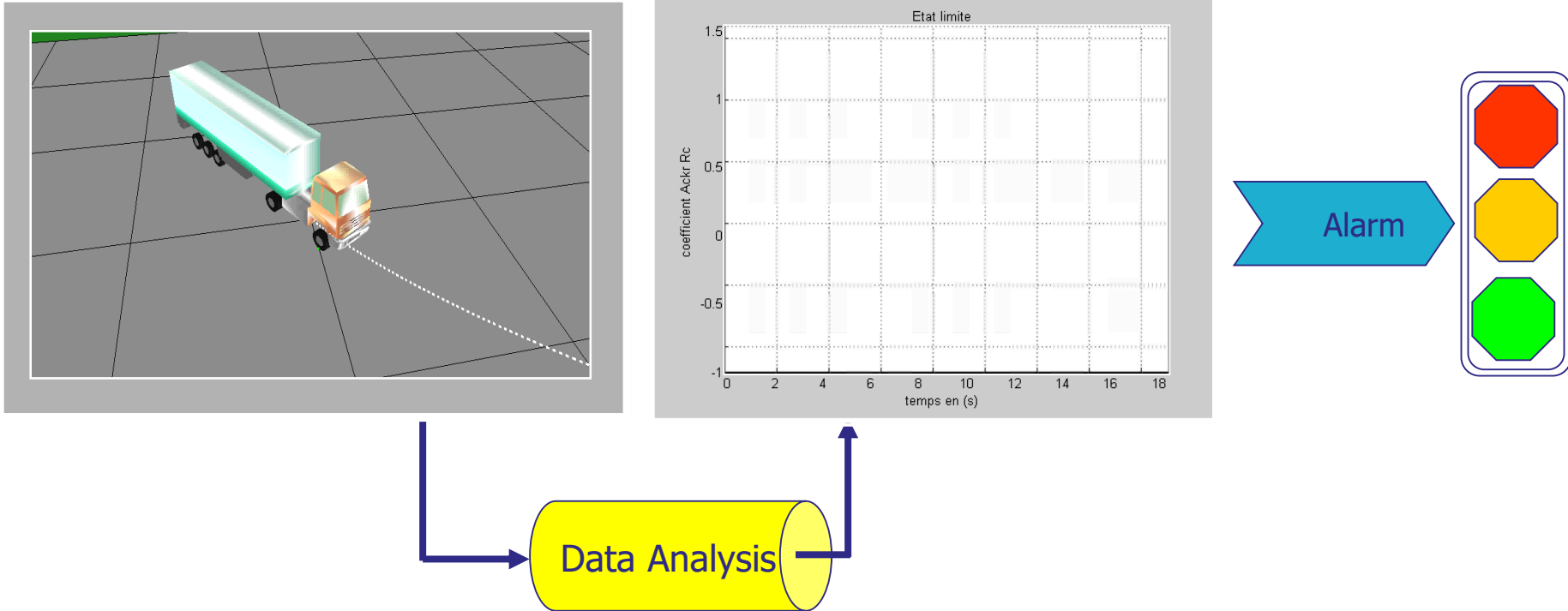



Rollover risk is detected when one of the two wheels of the same axle, lift off the road

→ LTR (Load Transfer Ratio)

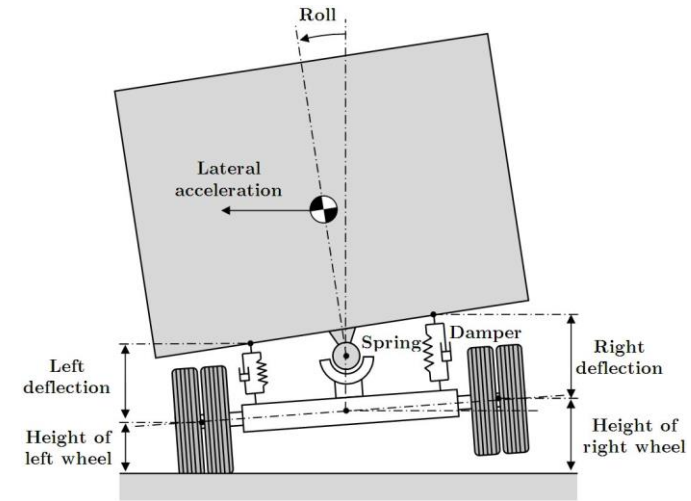

$$LTR = \frac{|F_{zL} - F_{zR}|}{F_{zL} + F_{zR}} = \frac{2m_2}{m \cdot T} \left| (h_0 + h \cos \phi) \frac{a_y}{g} + h \sin \phi \right| < R_{lim} = 1$$

$$a_y = \dot{v}_y + v\dot{\psi} - h\ddot{\phi}$$

$\sum F_{z,r} = 0$  → Right wheel lift off the road → rollover risk → LTR = -1.

$\sum F_{z,l} = 0$  → Left wheel lift off the road → rollover risk → LTR = 1.

$\sum F_{z,r} = \sum F_{z,l}$  → No rollover risk → LTR = 0.

## *High Order Sliding Mode Observer*

Vehicle states and Load Transfer Ratio computed using **High Order Sliding Mode Observer** :

- Robustness against perturbation and parameters variations
- Quick and finite time convergence of positions, speeds and accelerations
- Easier implementation

# System modelling

$$F_{ni} = F_{ci} + k_i(u_i - z_{ri}), i = 1..4$$

$$\begin{cases} \ddot{z}_{r1} = (K_1 q_1 - K_1 \frac{T}{2} \sin(\phi) + B_1 \dot{q}_1 - B_1 \frac{T}{2} \cos(\phi) \dot{\phi} - k_1 z_{r1} + k_1 u_1) \frac{1}{m_1} \\ \ddot{z}_{r2} = (K_2 q_2 + K_2 \frac{T}{2} \sin(\phi) + B_2 \dot{q}_2 + B_2 \frac{T}{2} \cos(\phi) \dot{\phi} - k_2 z_{r2} + k_2 u_2) \frac{1}{m_2} \end{cases}$$

$$\ddot{z} = (K_1 q_1 + K_2 q_2 + (K_1 - K_2) \frac{T}{2} \sin(\phi) + B_1 \dot{q}_1 + B_2 \dot{q}_2 - (B_1 - B_2) \frac{T}{2} \cos(\phi) \dot{\phi}) \frac{1}{M}$$

$$\begin{cases} z_{r1} = z - q_1 + \frac{T}{2} \sin(\phi) - r \\ z_{r2} = z - q_2 - \frac{T}{2} \sin(\phi) - r \end{cases}$$

$z$ : Centre height of gravity

$r$ : weel radius

$F_{ci}$ : static load

$F_{ni}$ : vertical force

$k_i$ : stifness

$U_i$ : Road profile

$\ddot{z}_{ri}$ : vertical acceleration of wheel  $i$

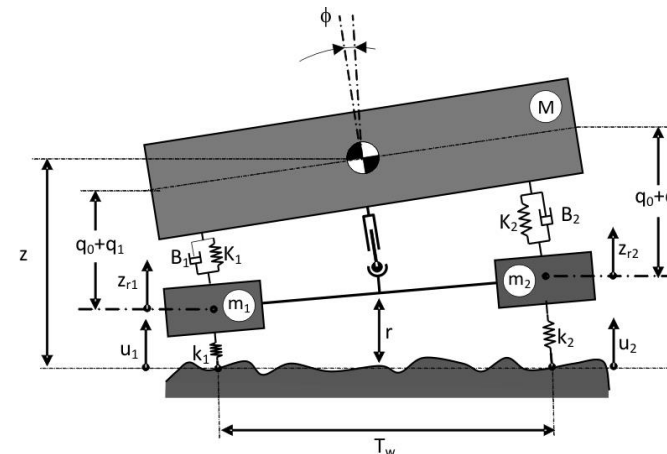

Suspension model

## HOSM Observer

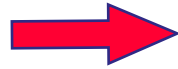

$$\begin{cases} \dot{\hat{x}}_1 = \hat{x}_2 - \lambda_0 |\hat{x}_1 - x_1|^{2/3} \text{sign}(\hat{x}_1 - x_1) \\ \dot{\hat{x}}_2 = \hat{x}_3 - \lambda_1 |\hat{x}_2 - \dot{\hat{x}}_1|^{1/2} \text{sign}(\hat{x}_2 - \dot{\hat{x}}_1) \\ \dot{\hat{x}}_3 = -\lambda_2 \text{sign}(\hat{x}_3 - \dot{\hat{x}}_2) \end{cases}$$

$\hat{x}_1, \hat{x}_2$  and  $\hat{x}_3$  are the estimated of  $x_1, x_2$  et  $\dot{x}_2$

$\lambda_0, \lambda_1$  and  $\lambda_2$  are the observer gains

## Dynamics error:

$$\begin{cases} \dot{\tilde{x}}_1 = x_2 - \hat{x}_2 + \lambda_0 |\hat{x}_1 - x_1|^{2/3} \text{sign}(\hat{x}_1 - x_1) \\ \dot{\tilde{x}}_2 = \dot{x}_2 - \hat{x}_3 + \lambda_1 |\hat{x}_2 - \dot{\hat{x}}_1|^{1/2} \text{sign}(\hat{x}_2 - \dot{\hat{x}}_1) \\ \ddot{\tilde{x}}_3 = \ddot{x}_2 + \lambda_2 \text{sign}(\hat{x}_3 - \dot{\hat{x}}_2) \end{cases}$$

$$\left\{ \begin{array}{l} \hat{z}_{r1} = (-m_1 \ddot{z}_{r1} + B_1 \dot{q}_1 + K_1 \frac{T_w}{2} \sin(\hat{\phi}) \\ + B_1 \frac{T_w}{2} \cos(\hat{\phi}) \dot{\hat{\phi}} + K_1 \hat{q}_1 + k_1 u_1) / k_1 \\ \hat{z}_{r2} = (-m_2 \ddot{z}_{r2} + B_2 \dot{q}_2 - K_2 \frac{T_w}{2} \sin(\hat{\phi}) \\ - B_2 \frac{T_w}{2} \cos(\hat{\phi}) \dot{\hat{\phi}} + K_2 \hat{q}_2 + k_2 u_2) / k_4 \end{array} \right.$$

**Suspension deflections and speeds estimated**

**→ Wheel's vertical displacements estimated**

$\ddot{z}_{ri}$  measured  $\Rightarrow \hat{z}_{ri} \rightarrow z_{ri}$

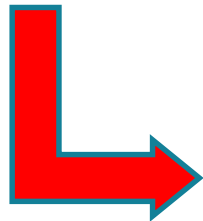

$$F_{ni} = F_{ci} + k_i (u_i - z_i), i = 1..4$$

**Vertical forces estimated**

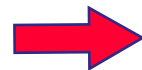

**Load Transfer Ratio calculated**

# Experimental results

## Instrumented vehicle



## Sensors inside the vehicle

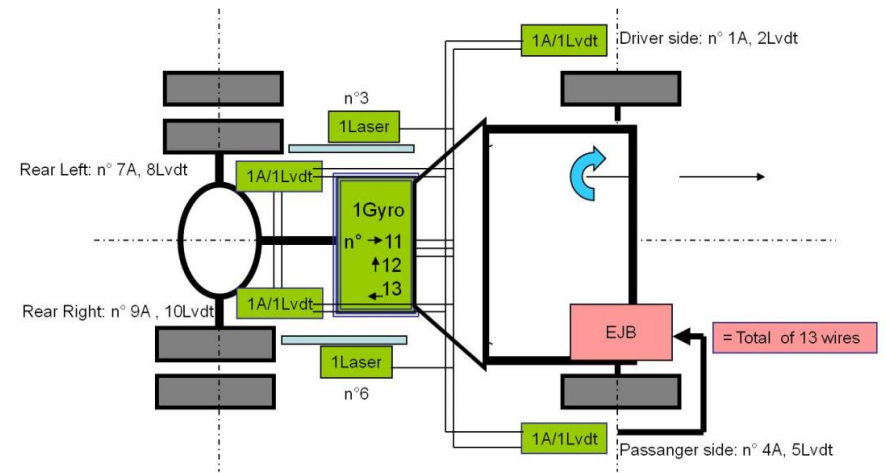

Y. DRIDI SRP / CVL

Infrastructure data base (Road profile,  
Longitudinal and lateral slopes, Adhesion)

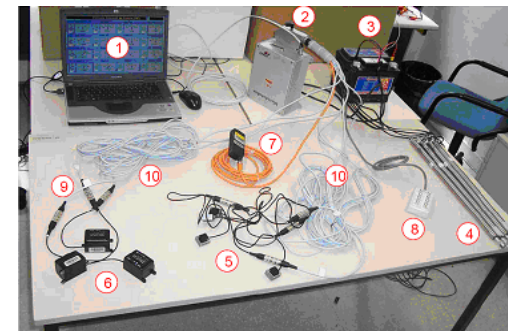

1. Control desk software
2. Autobox
3. Battery
4. LVDT sensors
5. Accelerometers
6. Gyrometers
7. Laser sensor
8. BNC connectors

## Many Tests:

- Straight line with constant speed of 50, 70 et 90km/h
- On all the site with constant speed of 50, 70 et 90km/h
- Braking in straight line
- Chicane Test

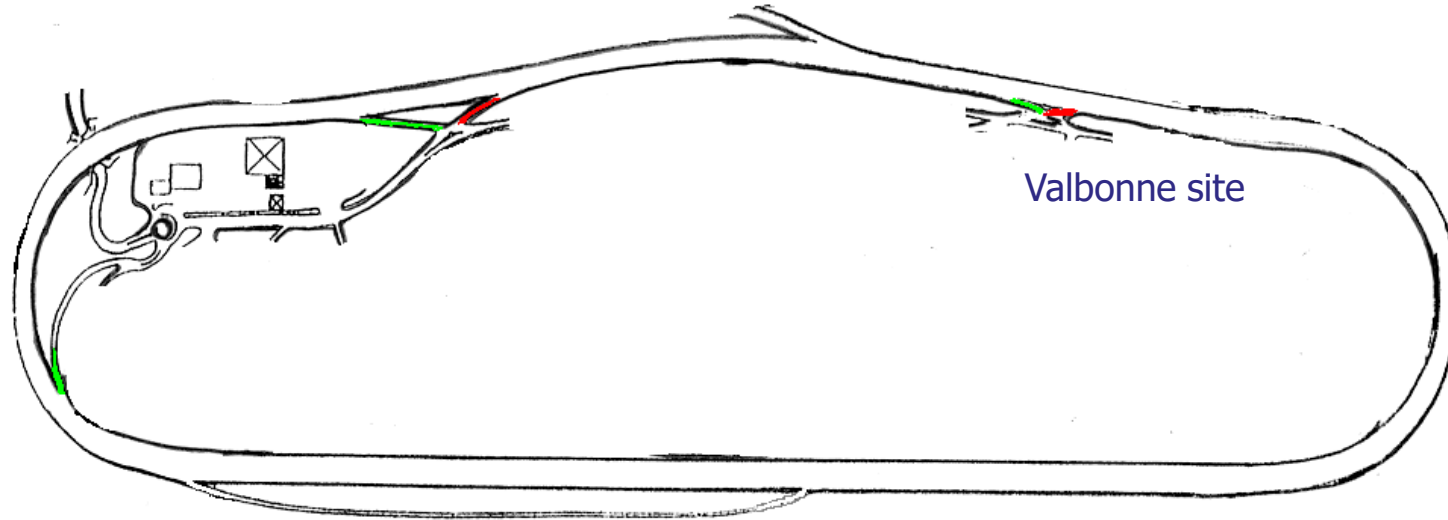

# Chicane test

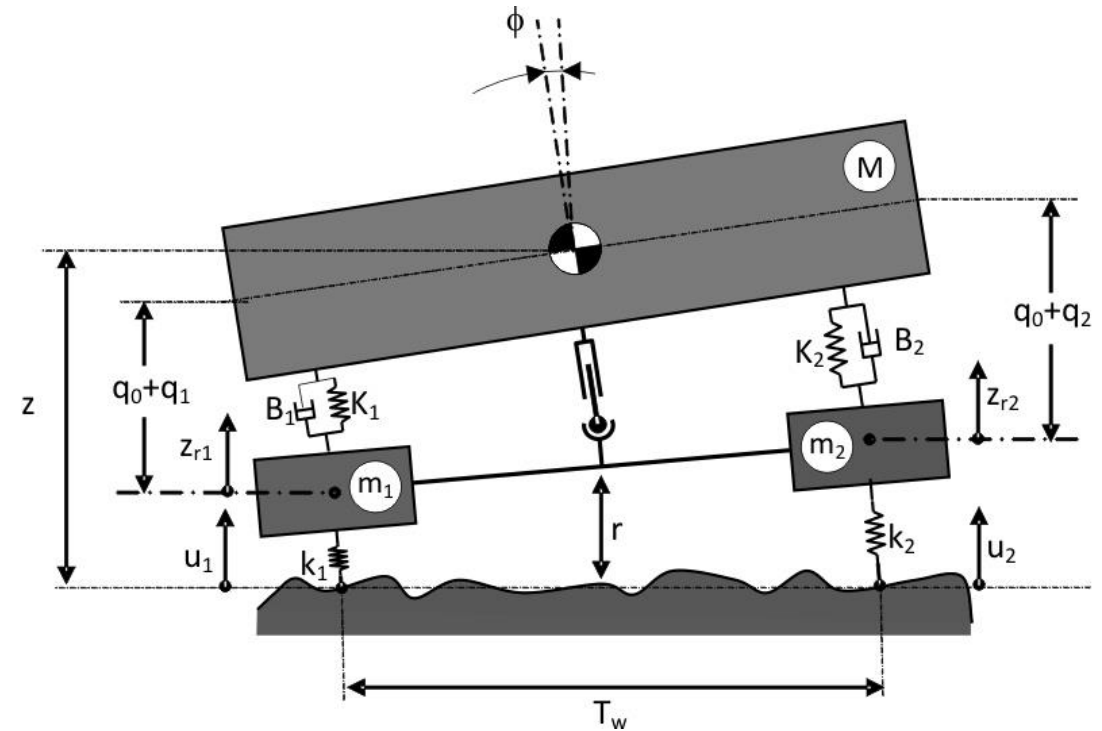



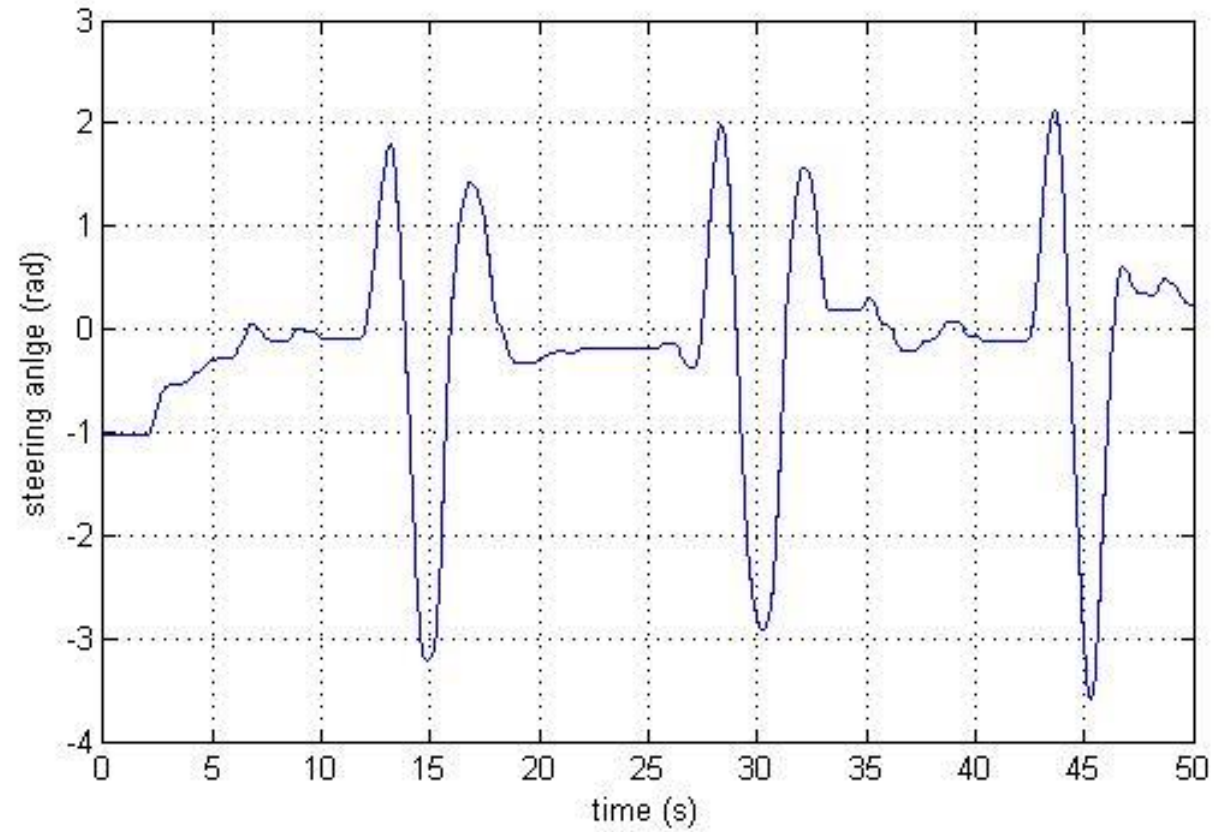

Steering angle

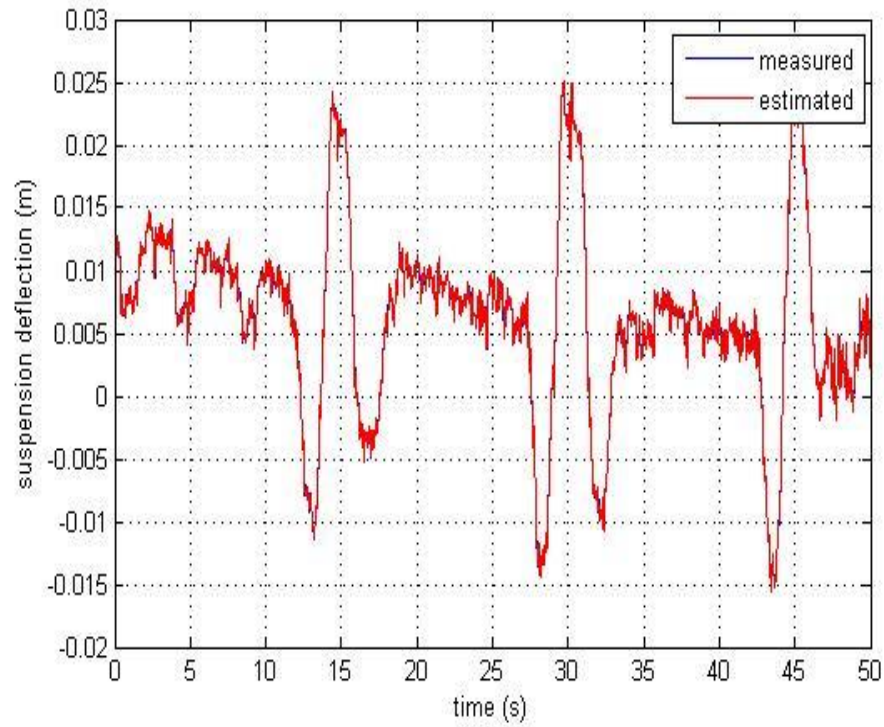

Suspension deflection

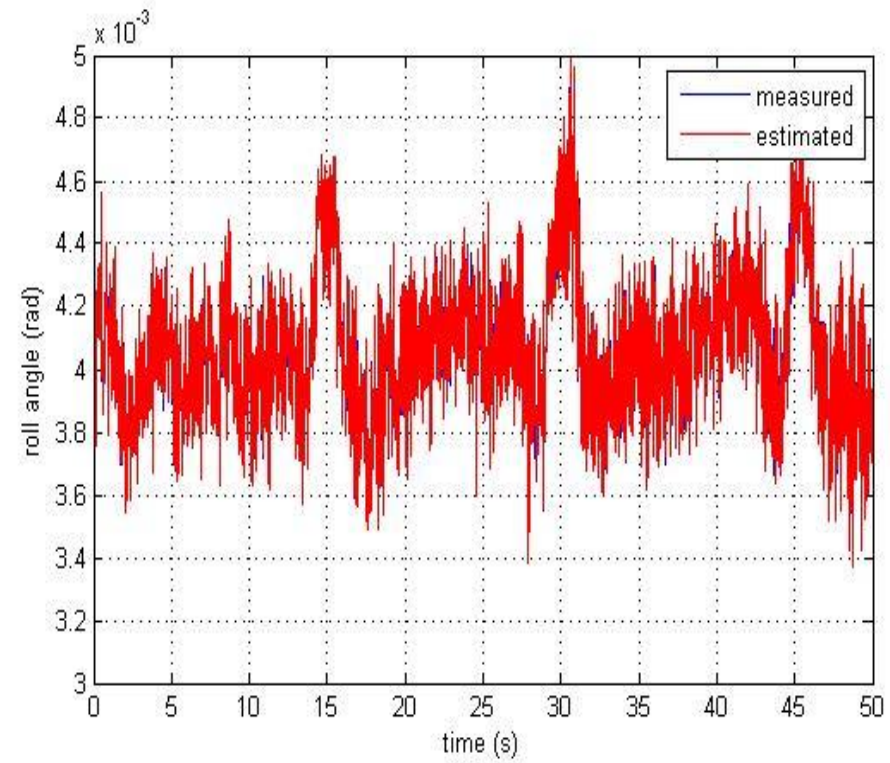

Roll angle

## Steering angle

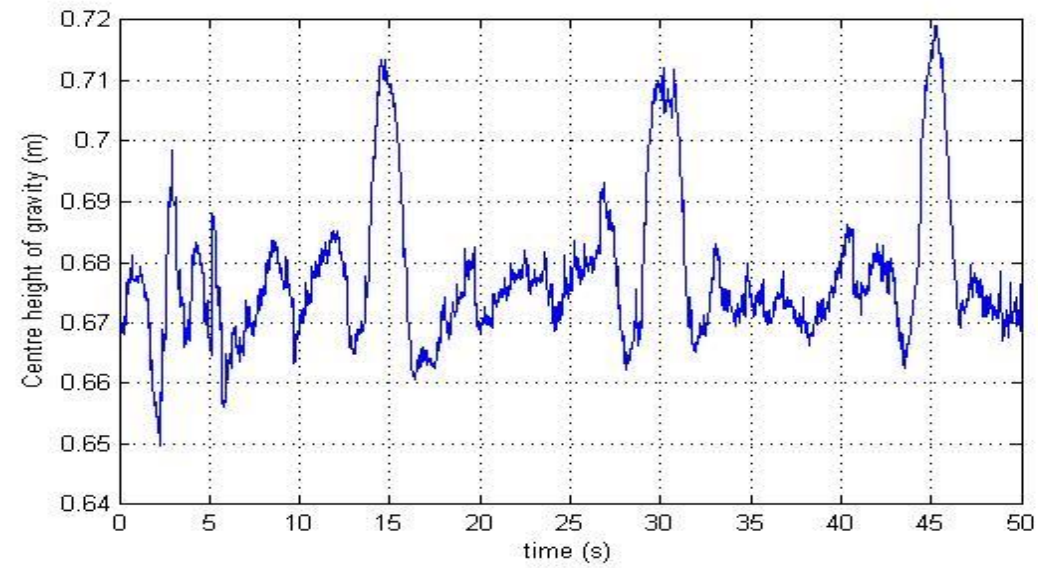
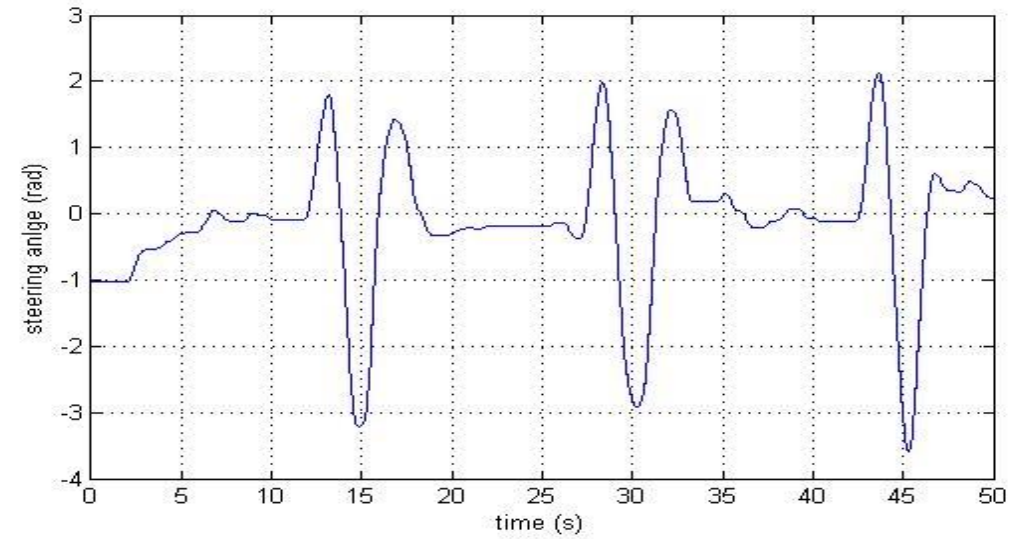

## Centre height of gravity estimation

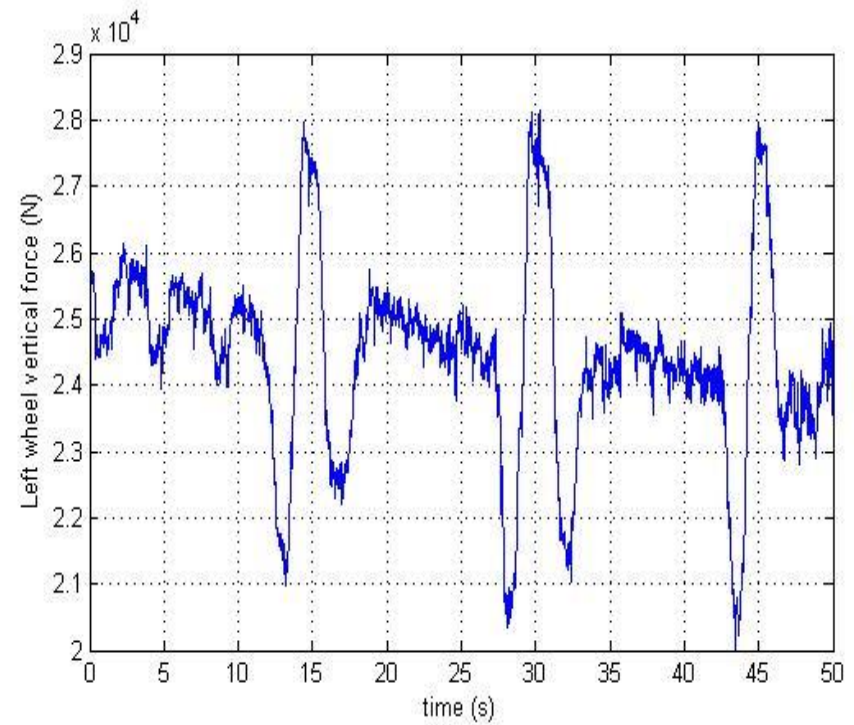
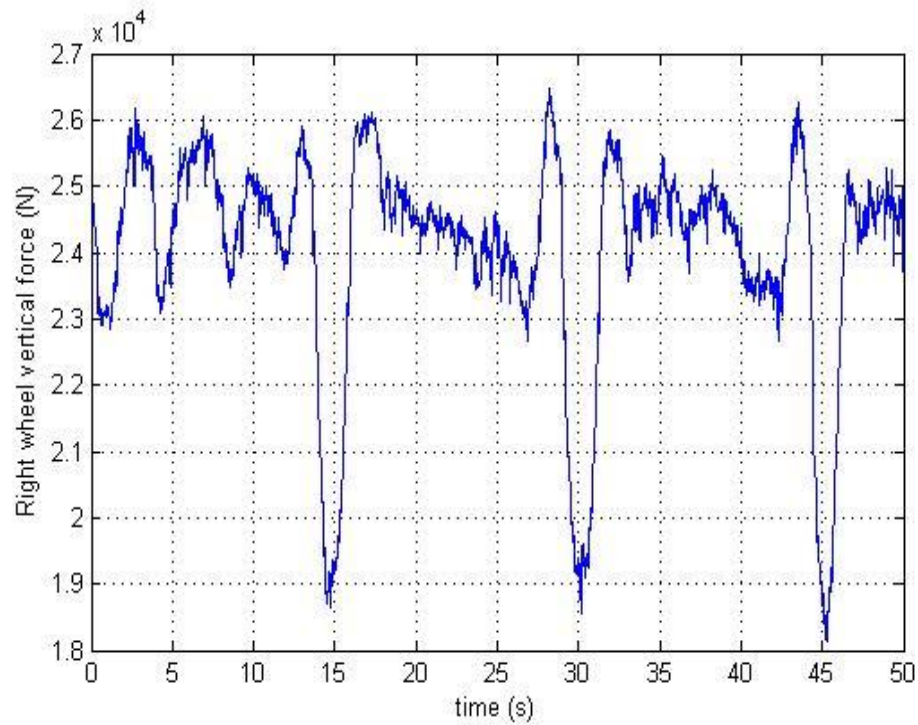

## Impact forces estimation

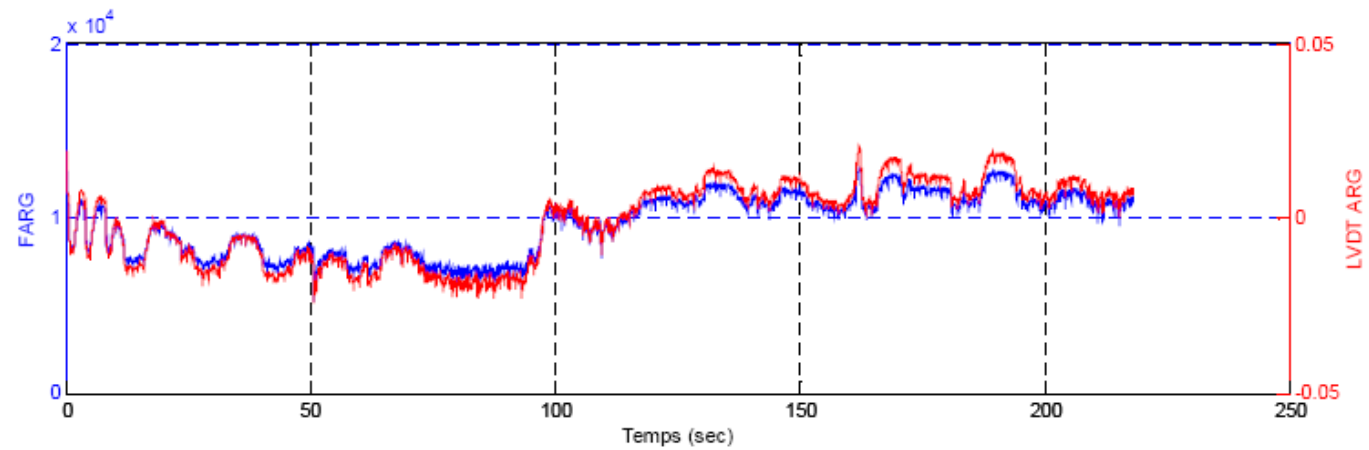
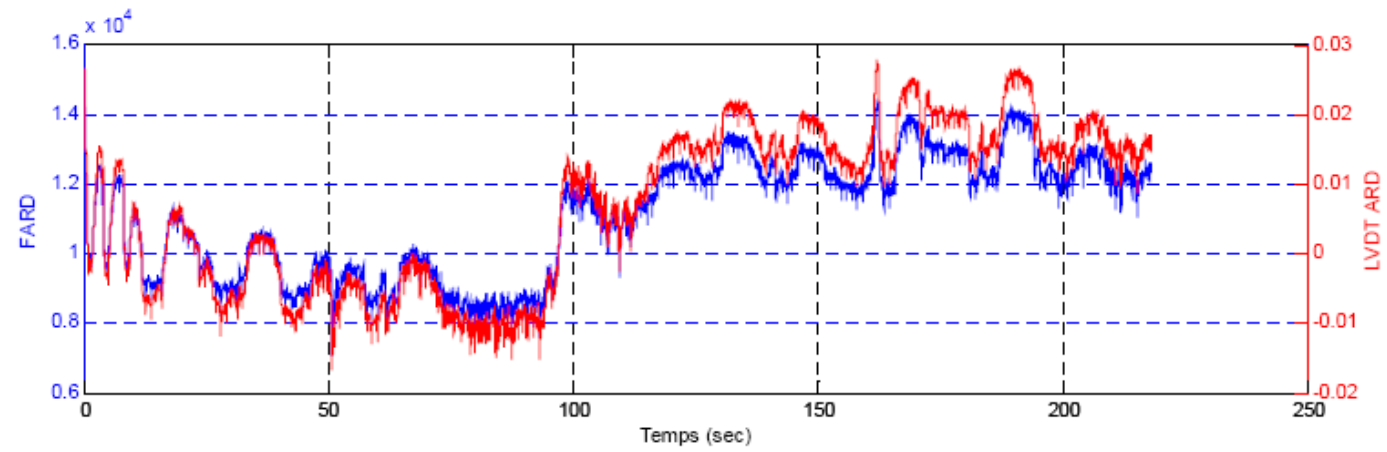

Impact forces compared to LVDT measures

## Load Transfer Ratio (LTR)

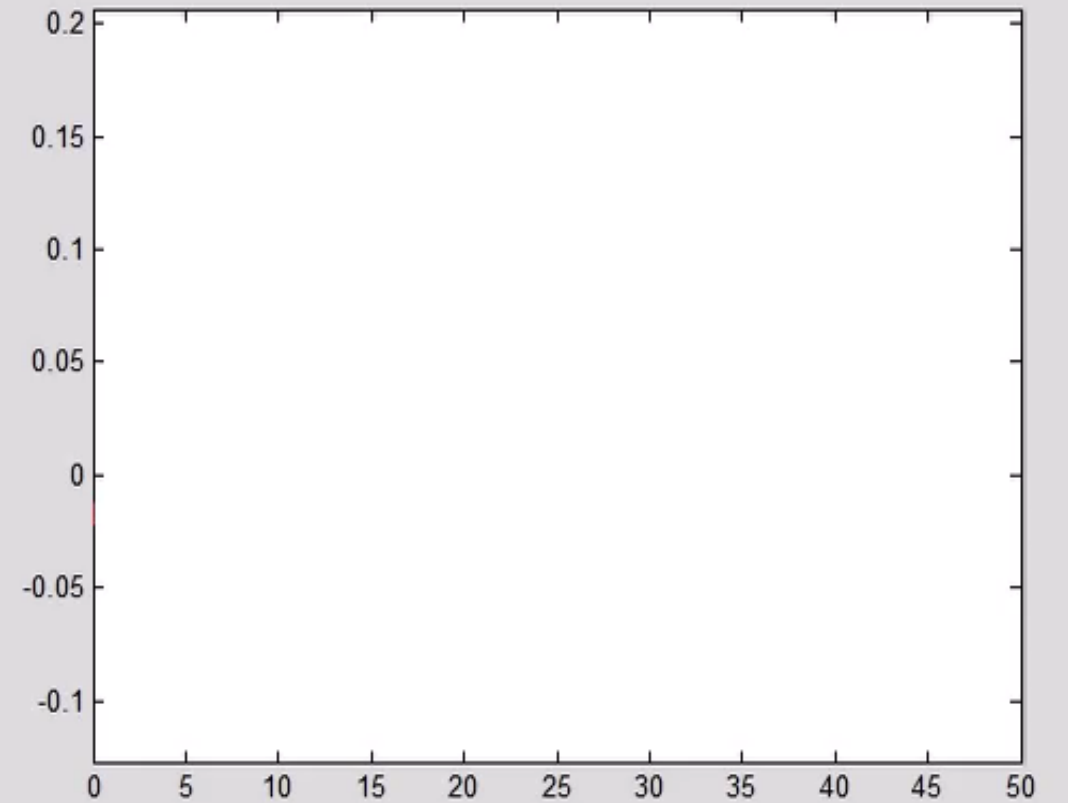

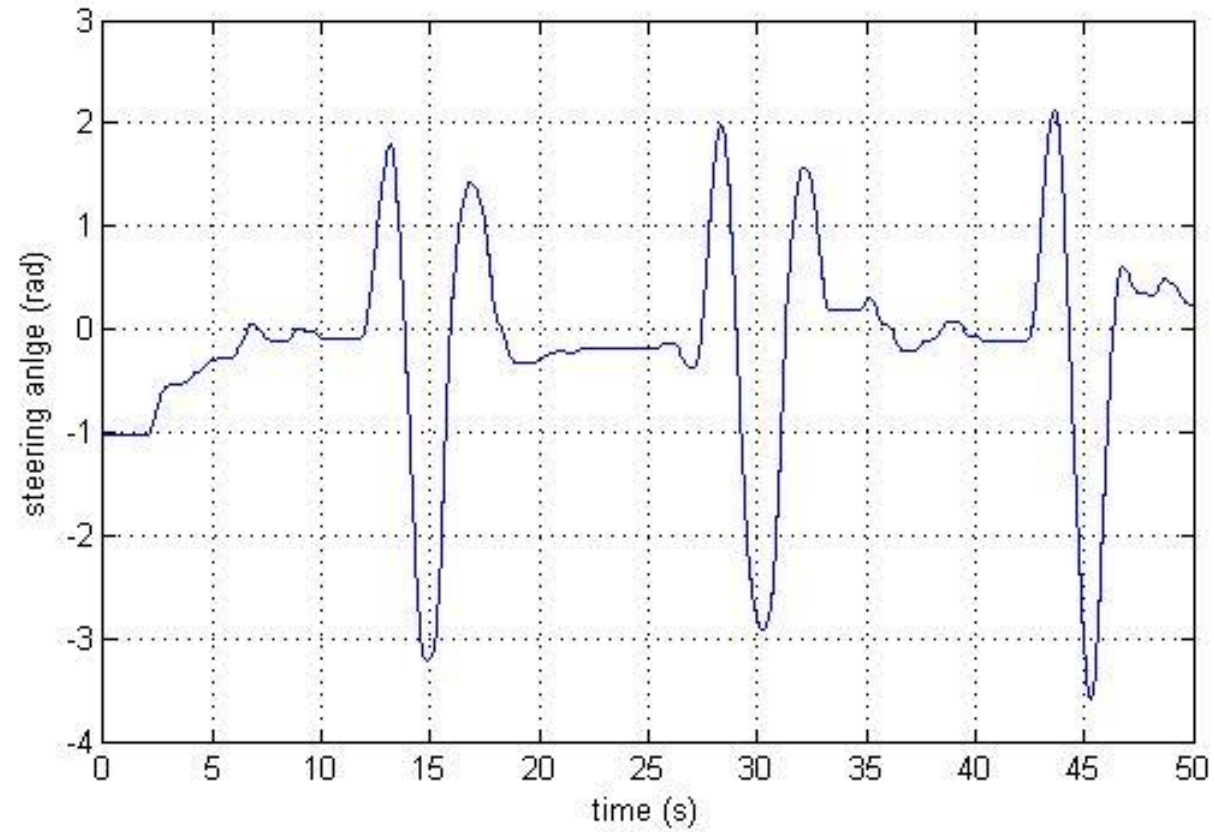

Steering angle

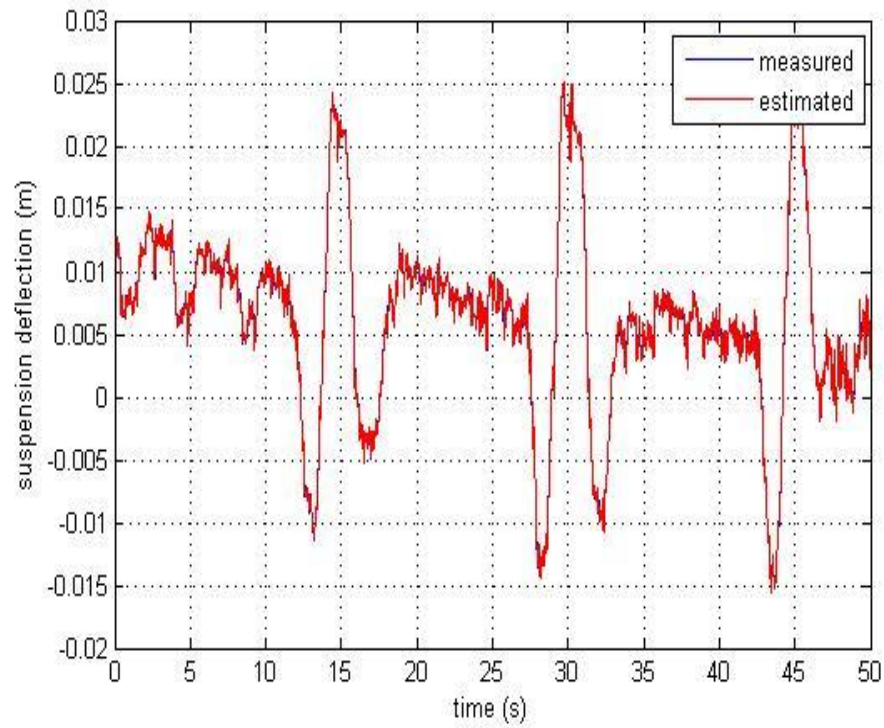

Suspension deflection

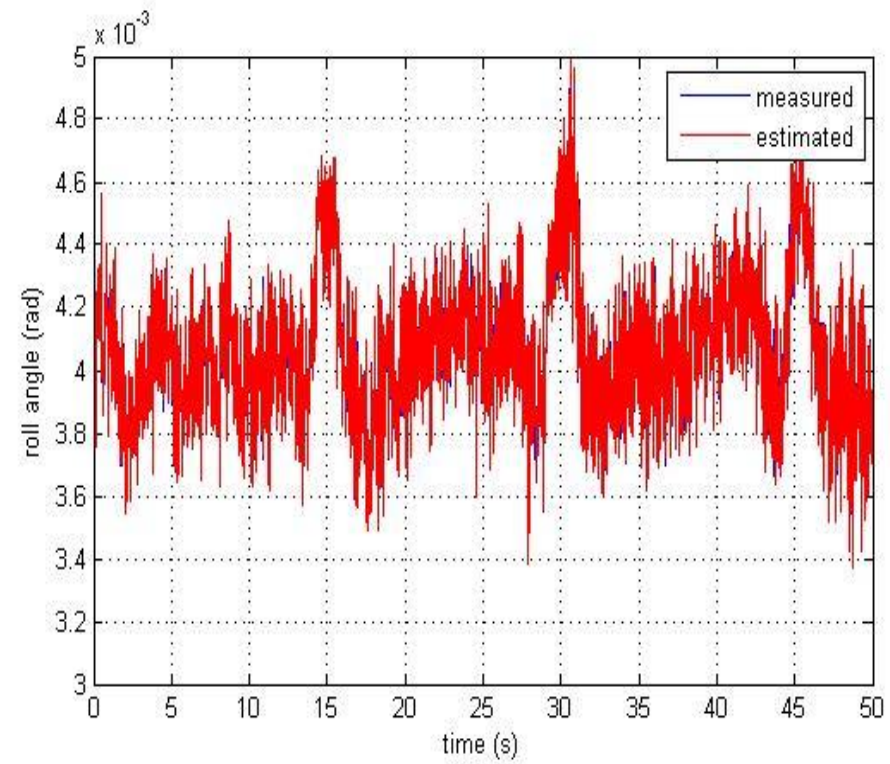

Roll angle



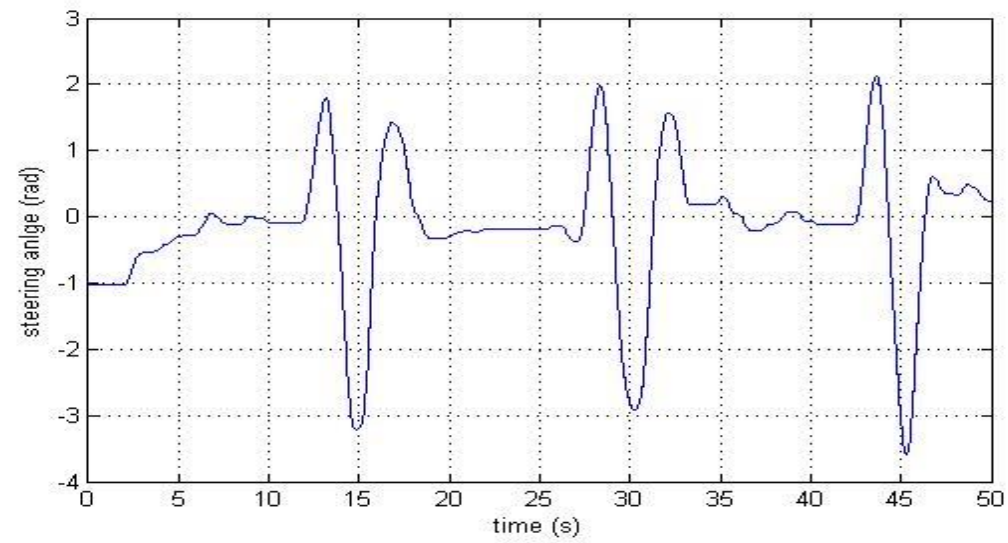

Steering angle

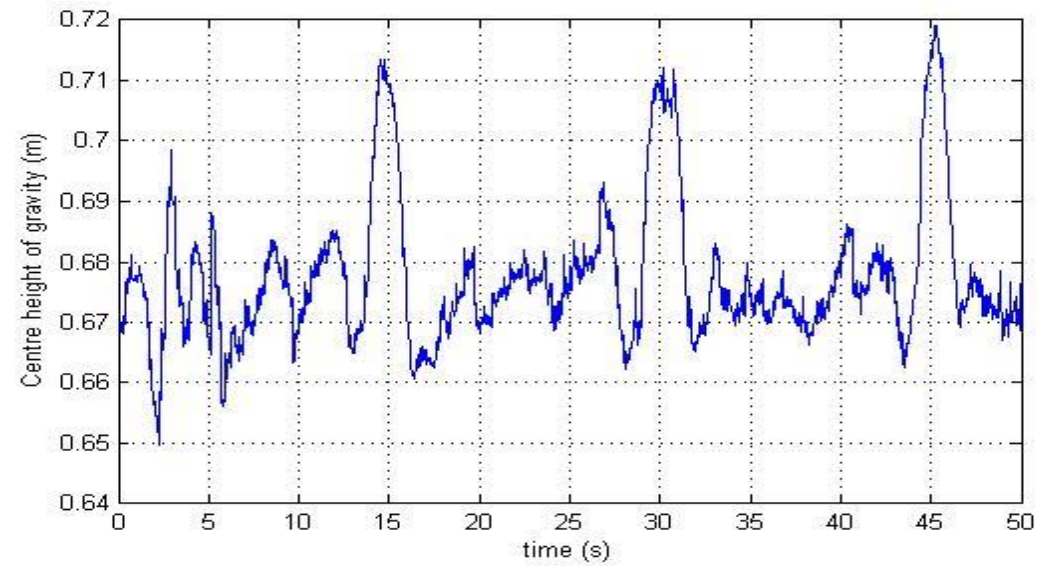

Centre height of gravity estimation

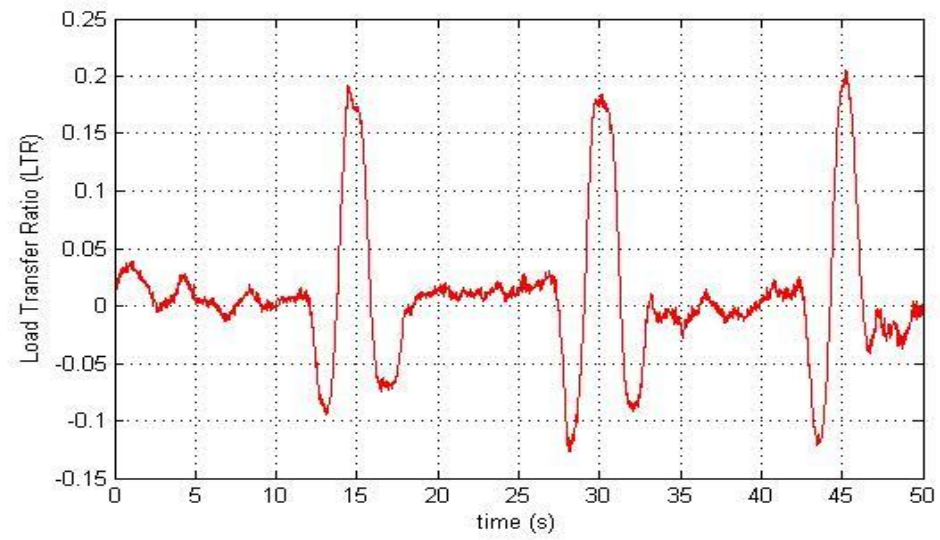

Load Transfer Ratio

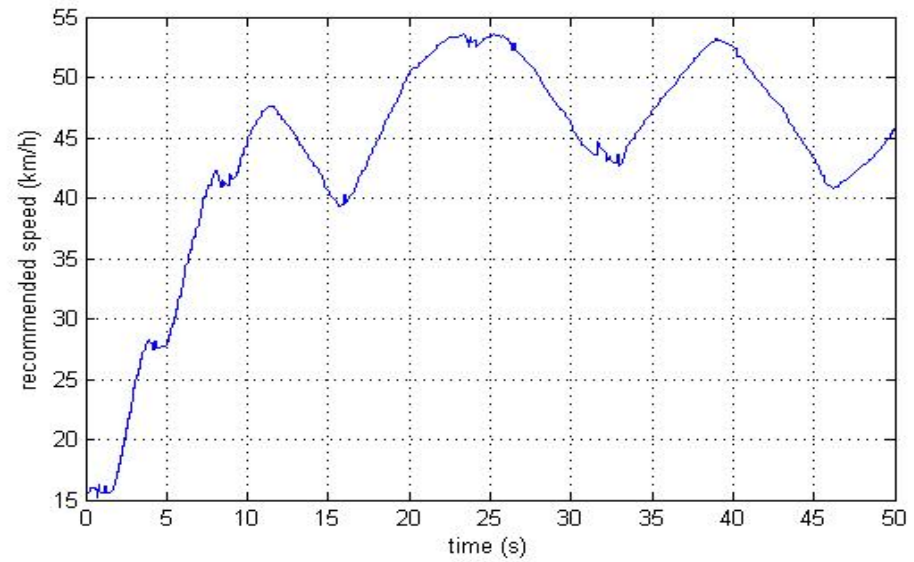

Recommended speed

Route 3

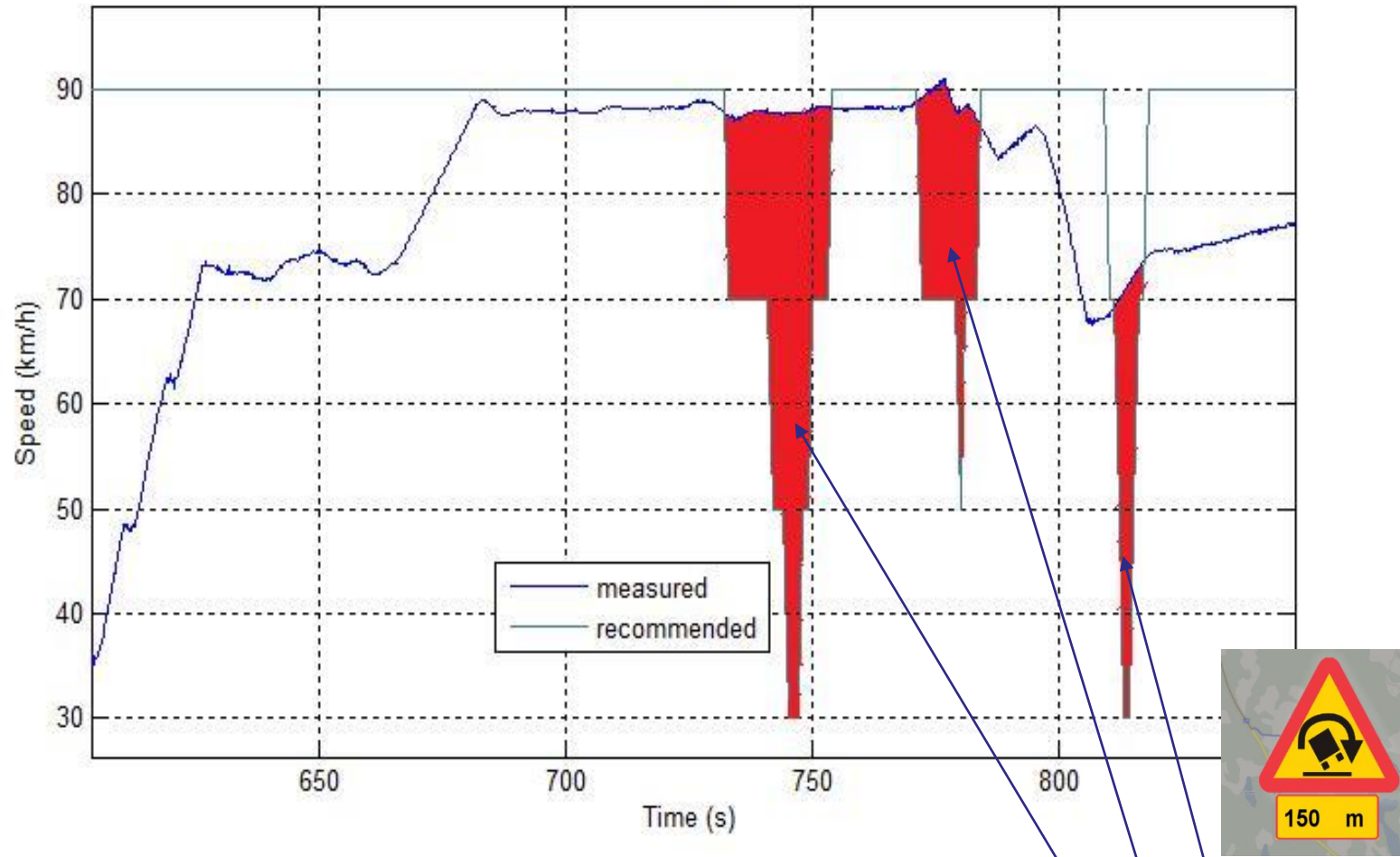

**Rollover risk area**

# Nonlinear control

## Advantages of the research :

- estimate the non measurable states of the HV.
- identify some unknown parameters of HV.
- robust control using super twisting algorithm

# Rollover avoidance

The aim of the developed steering control is to ensure the convergence of the lateral acceleration  $a_y$  of HGV to its acceleration limit  $a_{ylim}$ .

→ Bounded Load transfer between the right and the left side of HGV to its limited value 0.9.

The control algorithm is defined as:

$$\begin{cases} \delta_a = u_{eq} - G_1 |S|^{1/2} \text{sign}(S) + u_1 \\ \dot{u}_1 = -G_2 \text{sign}(S) \end{cases}$$

$$S = \dot{\tilde{y}} + \lambda \tilde{y}$$

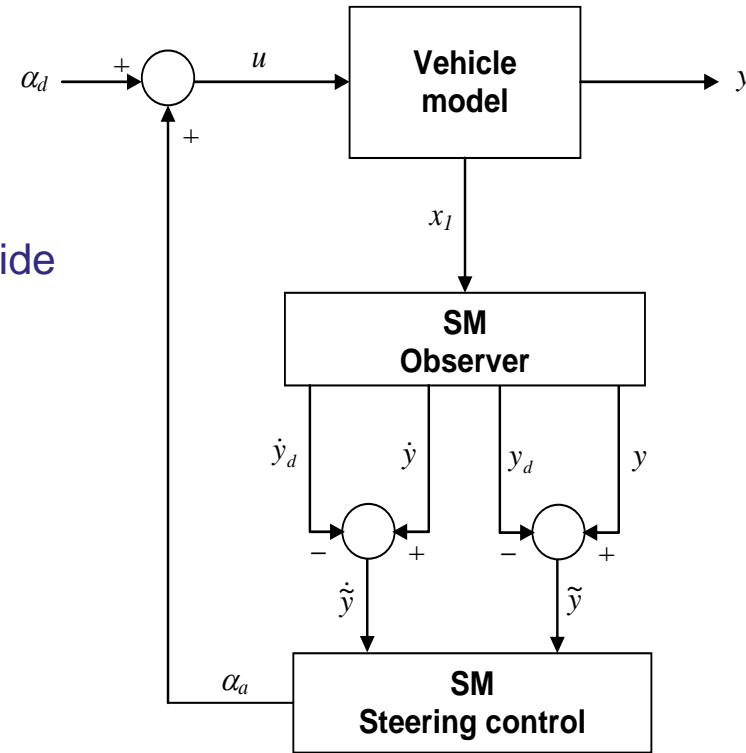

# Simulation results

Simulation results for a driver steering input zigzag

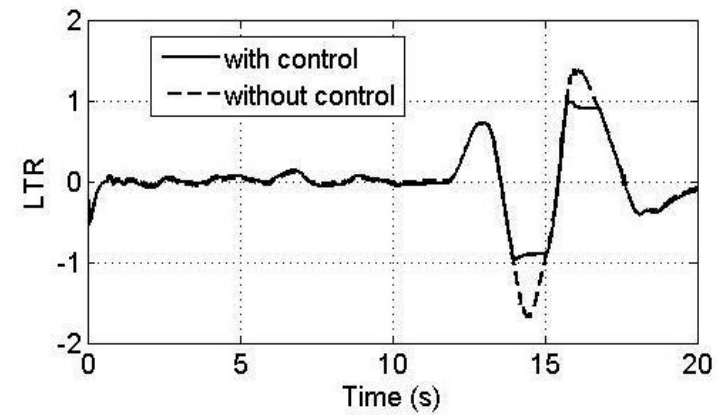
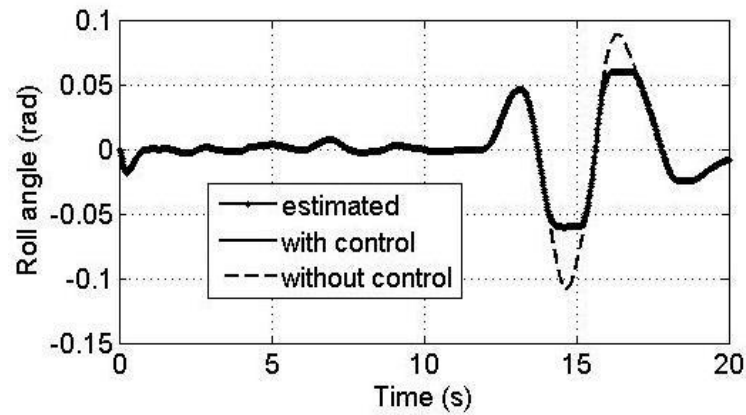
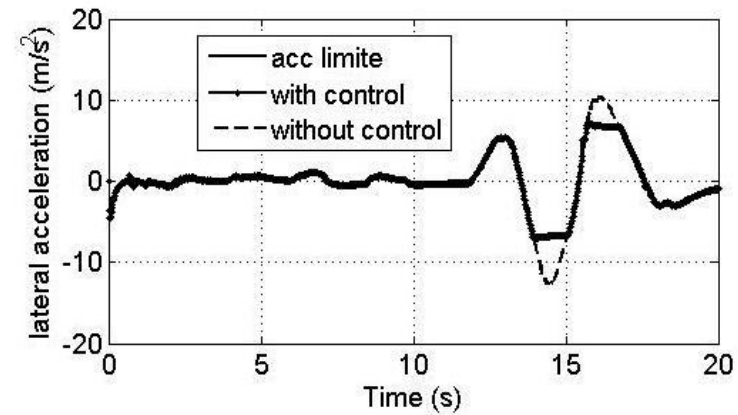
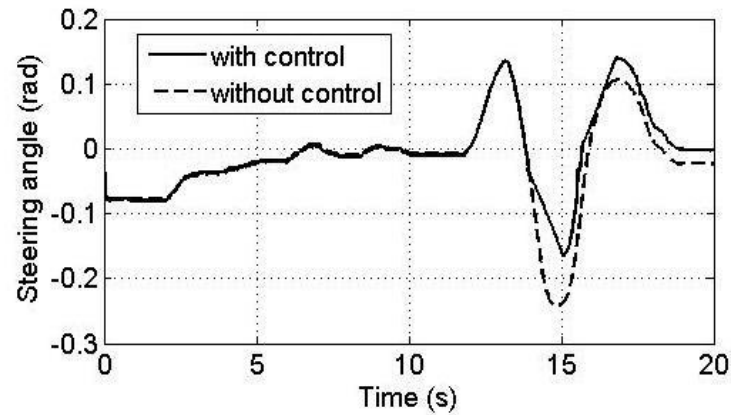

# Lane departure avoidance

Lane keeping assistance is based on the control of lateral position, yaw angle and their respective speed in order to keep the HGV in the centre of the line.

$$y_r = y_l + \psi$$

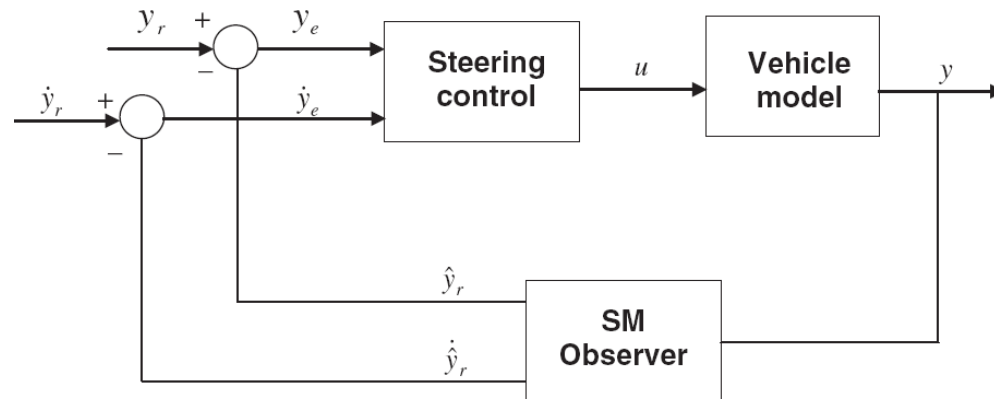

The control algorithm is defined by:

$$\begin{cases} u = u_{eq} - k_1 |S|^{1/2} \text{sign}(S) + u_1 \\ \dot{u}_1 = -k_2 \text{sign}(S) \end{cases}$$

$$S = \dot{y}_e + \lambda y_e$$

# Simulation results

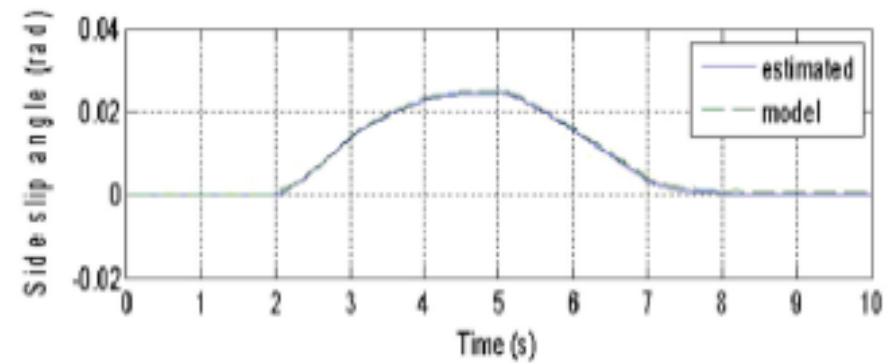
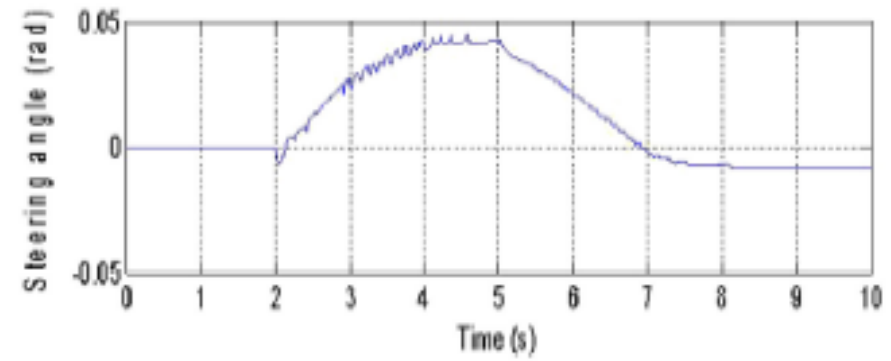
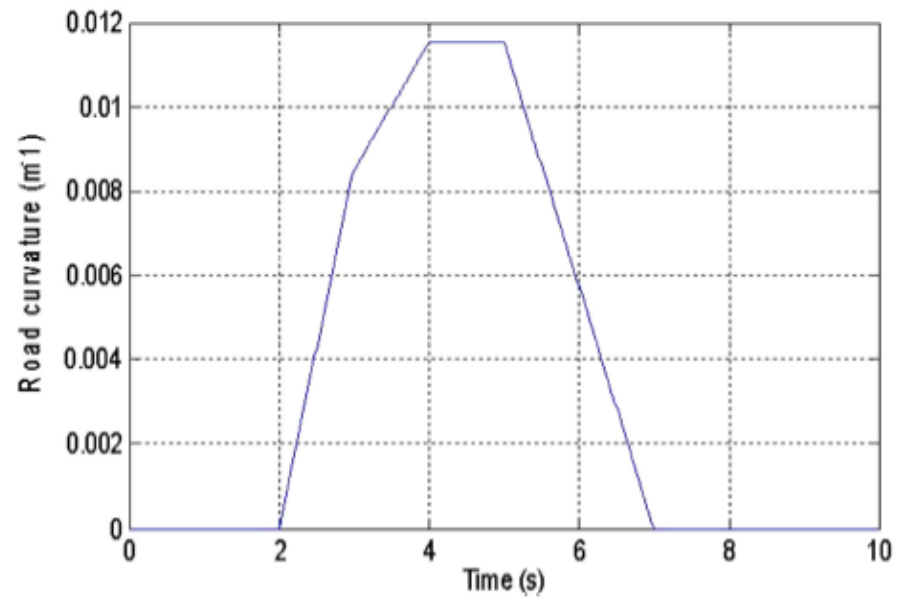



## Actual and future works

### Study the effects of road characteristics on simulators (Car and Bicycle)

In order to improve the safety and stability of this kind of vehicles, following tasks have been achieved:

- ✓ Develop new models of vehicles, taking into account the road characteristics.
- ✓ Simulate the driver's perception in vehicle control tasks.
- ✓ Tests on simulator and model validation
- ✓ Analyse the road characteristics and their influence on the safety.
- ✓ Define drivers and trajectories classes.
- ✓ Real tests with instrumented vehicles.

# Car Simulator

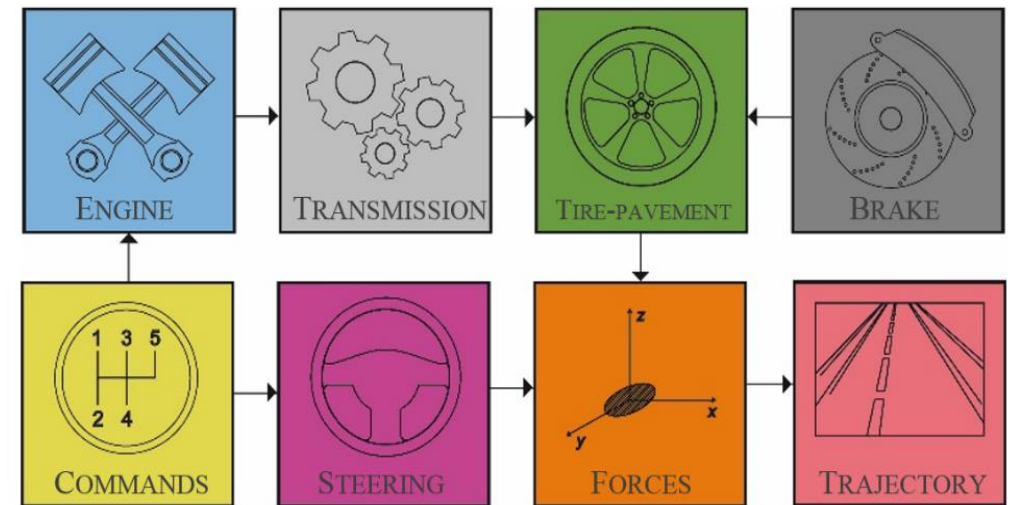

# Bicycle simulator

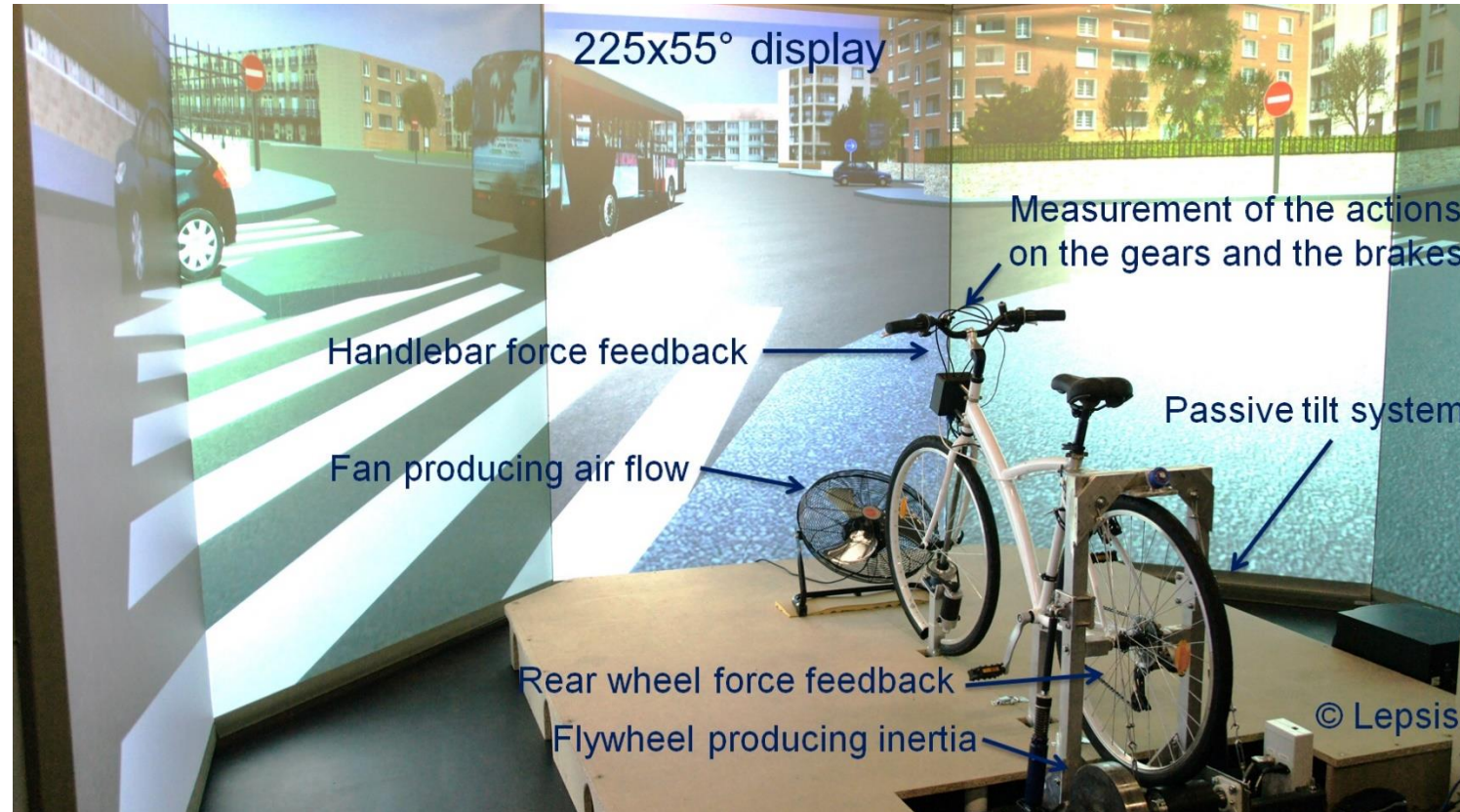



# Bicycle simulator

## Ifsttar