

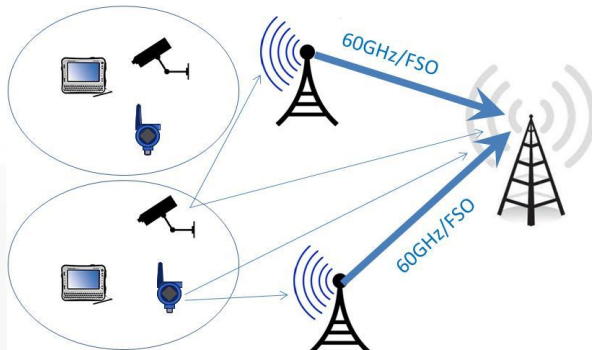

Recent Developments in Optical Wireless Communication Systems

Mohamed-Slim Alouini and Ki-Hong Park

ICWMC 2020
October 2020 - Porto, Portugal



Presenters



Mohamed-Slim Alouini is a Professor of ECE at King Abdullah University of Science and Technology (KAUST), Thuwal, Makkah Province, Saudi Arabia. His general research interests include the modeling, design, and performance analysis of wireless communication systems. He is currently actively working on addressing the uneven global distribution, access to, and use of information and communication technologies by studying and developing new generations of satellite constellations as a solution to provide connectivity to far-flung or less-populated areas.



Ki-Hong Park is a Research Scientist of ECE at KAUST. His research interests include communication theory and its application to the design and performance evaluation of wireless communication systems and networks. His most recent research interests include the application to underwater visible light communication, optical wireless communications, unmanned aerial vehicle communication, and physical layer secrecy.



Agenda

- **Spectrum Scarcity**
 - Radio Frequency (RF) spectrum
 - Mobile traffic growth and spectrum scarcity
 - Potential solutions
- **Free Space Optical (FSO) Communications**
 - Impact of turbulence
 - Impact of pointing errors
 - Recent results and on-going research directions
 - Pointing, acquisition and tracking (PAT)
 - UAV Communications and FSO
- **Concluding Remarks**



Spectrum Scarcity

Challenges and Solutions



RF Spectrum

- RF spectrum typically refers to the full frequency range from 3 KHz to 300 GHz.
- RF spectrum is a national resource that is typically considered as an exclusive property of the state.
- RF spectrum usage is regulated and optimized
- RF spectrum is allocated into different bands and is typically used for
 - Radio and TV broadcasting
 - Government (defense and public safety) and industry
 - Commercial services to the public (voice and data)

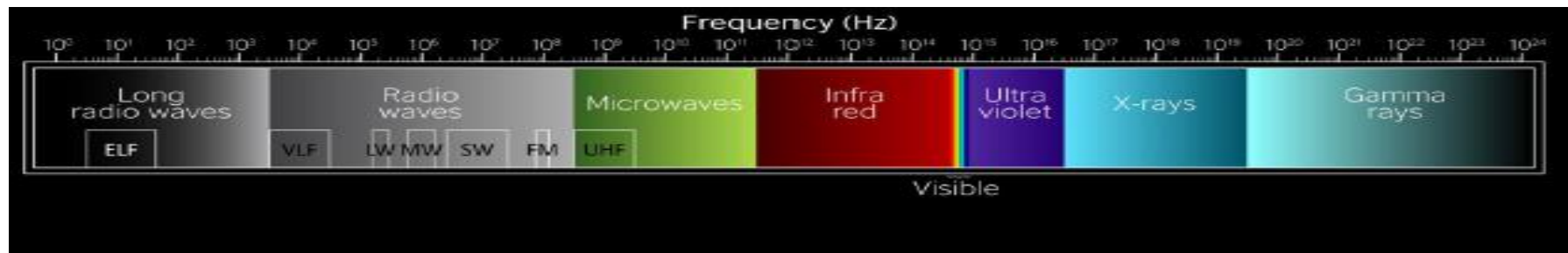

US Frequency Allocation Chart

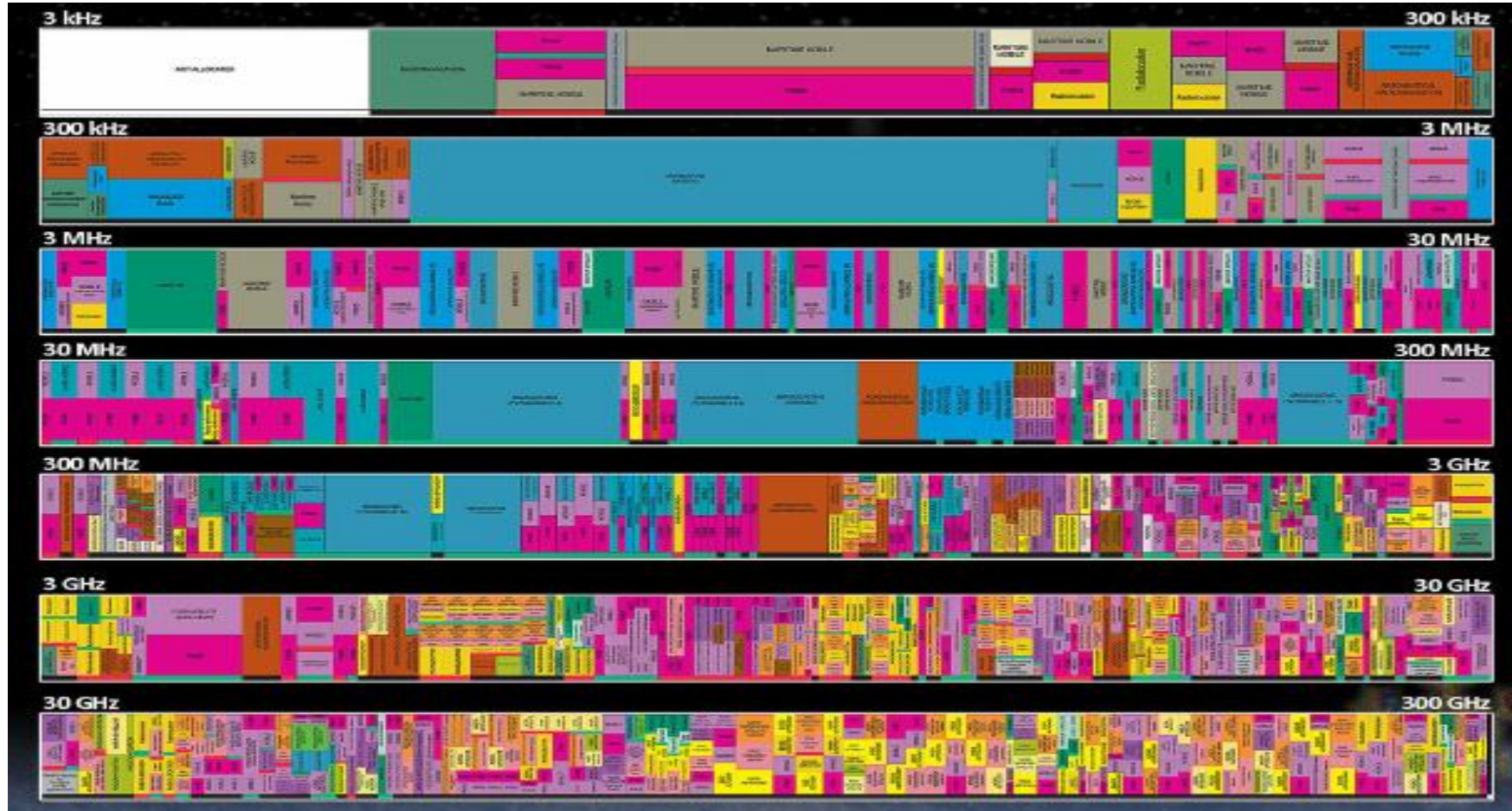

Growth of Mobile Phone Subscribers

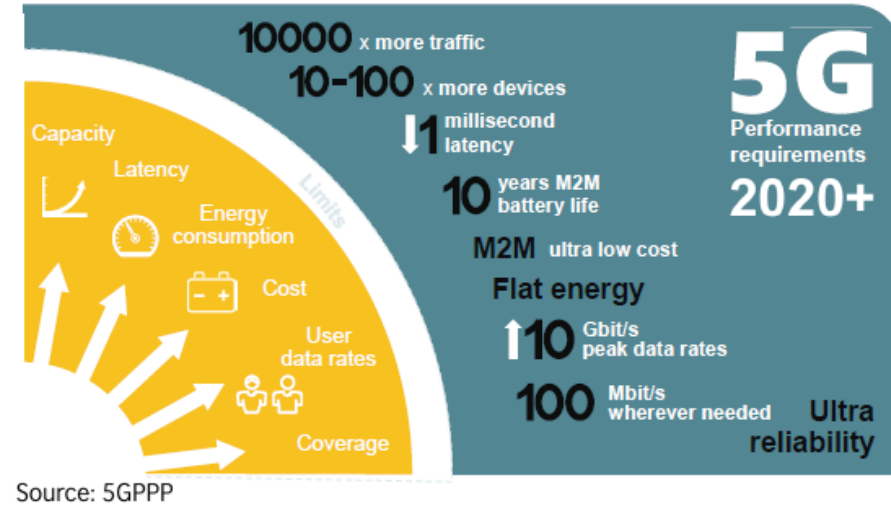
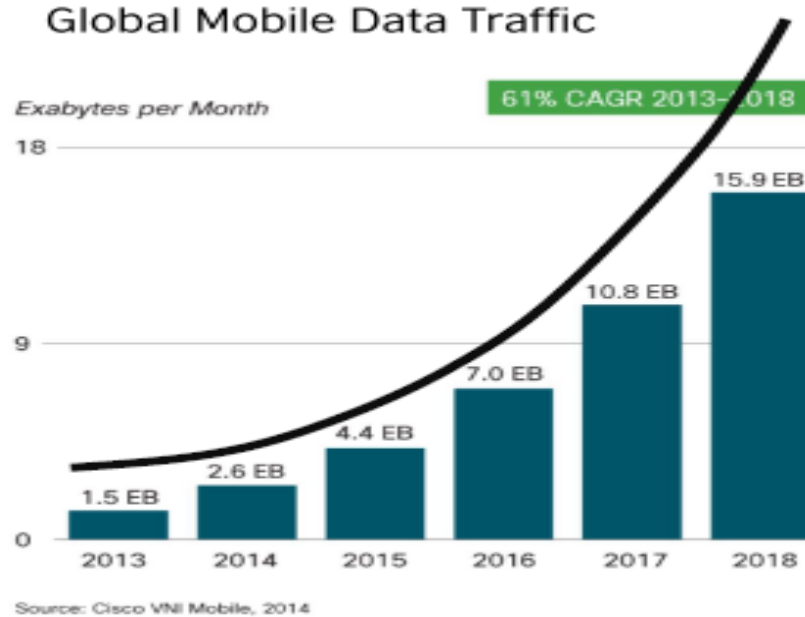

Mobile internet traffic is pushing the capacity limits of wireless networks !



RF Spectrum “Crunch”

- Smartphone usage tripled in 2011.
- Between 2011 and 2016, global wireless data traffic is expected to increase 18 times more.
- Rapid increase in the use of wireless services has lead the problems of RF spectrum *exhaustion* and eventually RF spectrum *deficit*.
- FCC predicts that the US would start experiencing a spectrum deficit for wireless communications at some point.



Potential Solution

- More efficient usage of the available spectrum:
 - Multiple antenna systems
 - Adaptive modulation and coding systems



Other Potential Solutions

- More aggressive temporal and spatial reuse of the available spectrum:
 - Cognitive radio systems
 - Femto cells & offloading solutions
- Use of unregulated bandwidth in the upper portion of the spectrum:
 - Microwave and millimeter-wave such as 60 GHz & 90 GHz
 - THz carriers
 - Optical spectrum



Optical Spectrum

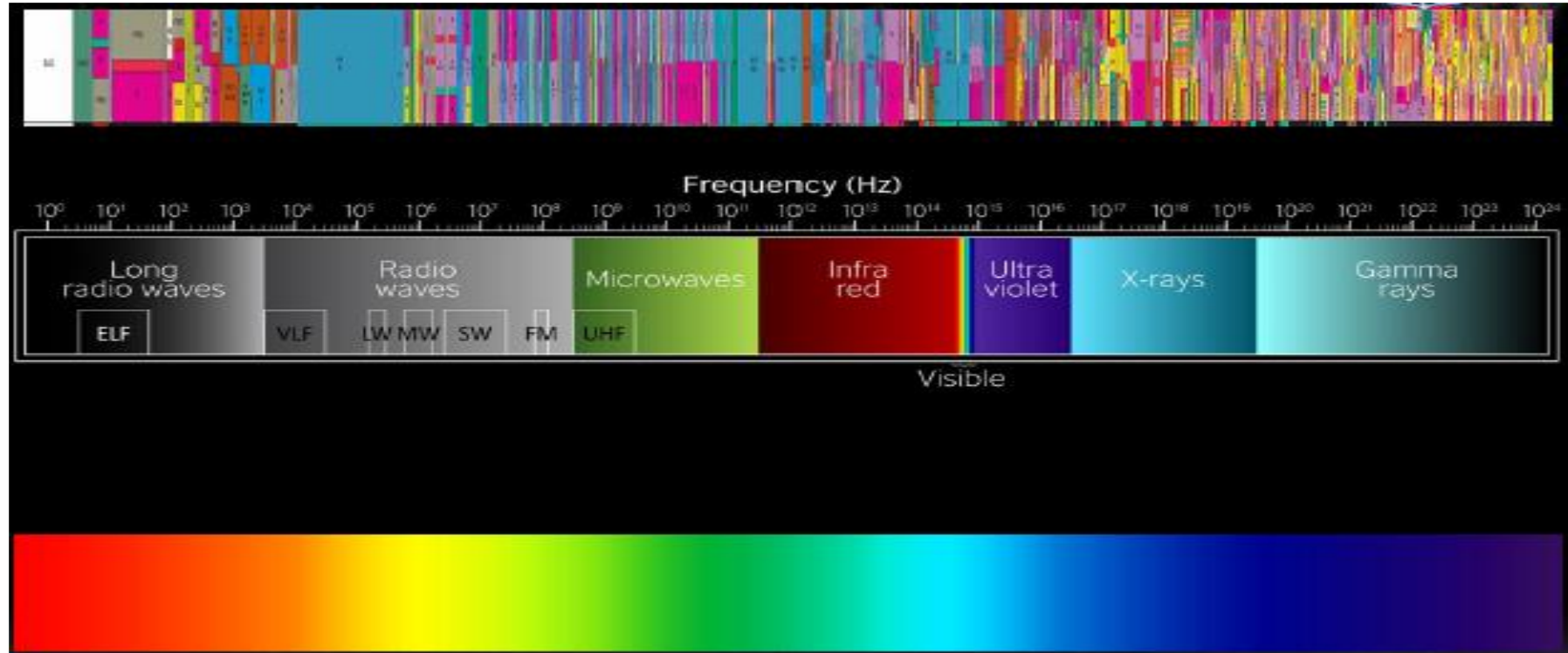

Visible spectrum is 10 thousands times larger than the RF spectrum !

Optical Wireless Communications

- Point-to-point free space optical communications (FSO)
- Visible light communications (know also as Li-Fi for Light-Fidelity)
- NLOS UV communication
- Underwater optical communication

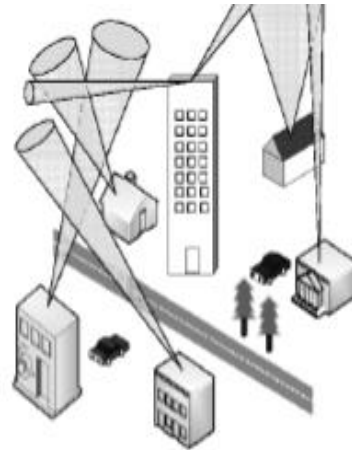

Free Space Optical (FSO) Communications

Towards the Speeds of Wireline Networks





Recent Developments in Optical Wireless Communication Systems

Mohamed-Slim Alouini and Ki-Hong Park

ICWMC 2020
October 2020 - Porto, Portugal

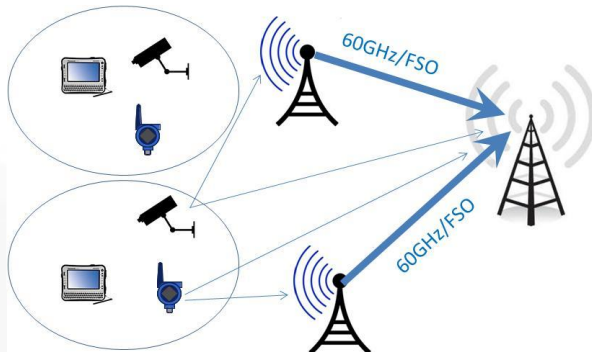

Agenda

- **Spectrum Scarcity**
 - Radio Frequency (RF) spectrum
 - Mobile traffic growth and spectrum scarcity
 - Potential solutions
- **Free Space Optical (FSO) Communications**
 - Impact of turbulence
 - Impact of pointing errors
 - Recent results and on-going research directions
 - Pointing, acquisition and tracking (PAT)
 - UAV Communications and FSO
- **Concluding Remarks**



Spectrum Scarcity

Challenges and Solutions



RF Spectrum

- RF spectrum typically refers to the full frequency range from 3 KHz to 300 GHz.
- RF spectrum is a national resource that is typically considered as an exclusive property of the state.
- RF spectrum usage is regulated and optimized
- RF spectrum is allocated into different bands and is typically used for
 - Radio and TV broadcasting
 - Government (defense and public safety) and industry
 - Commercial services to the public (voice and data)

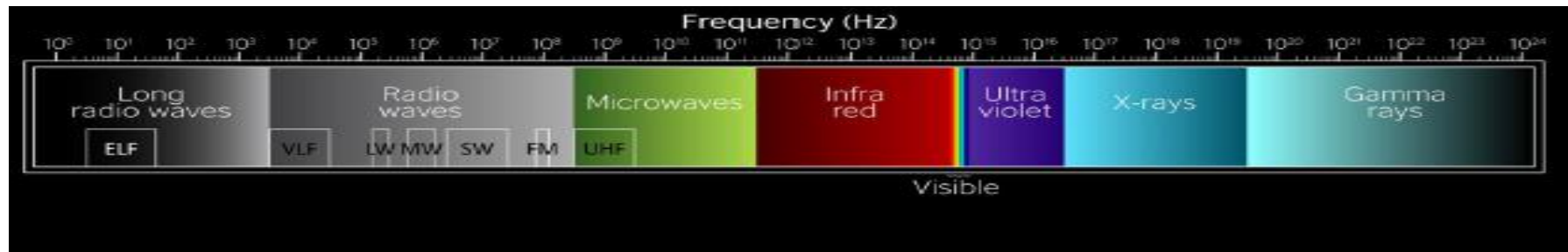

US Frequency Allocation Chart

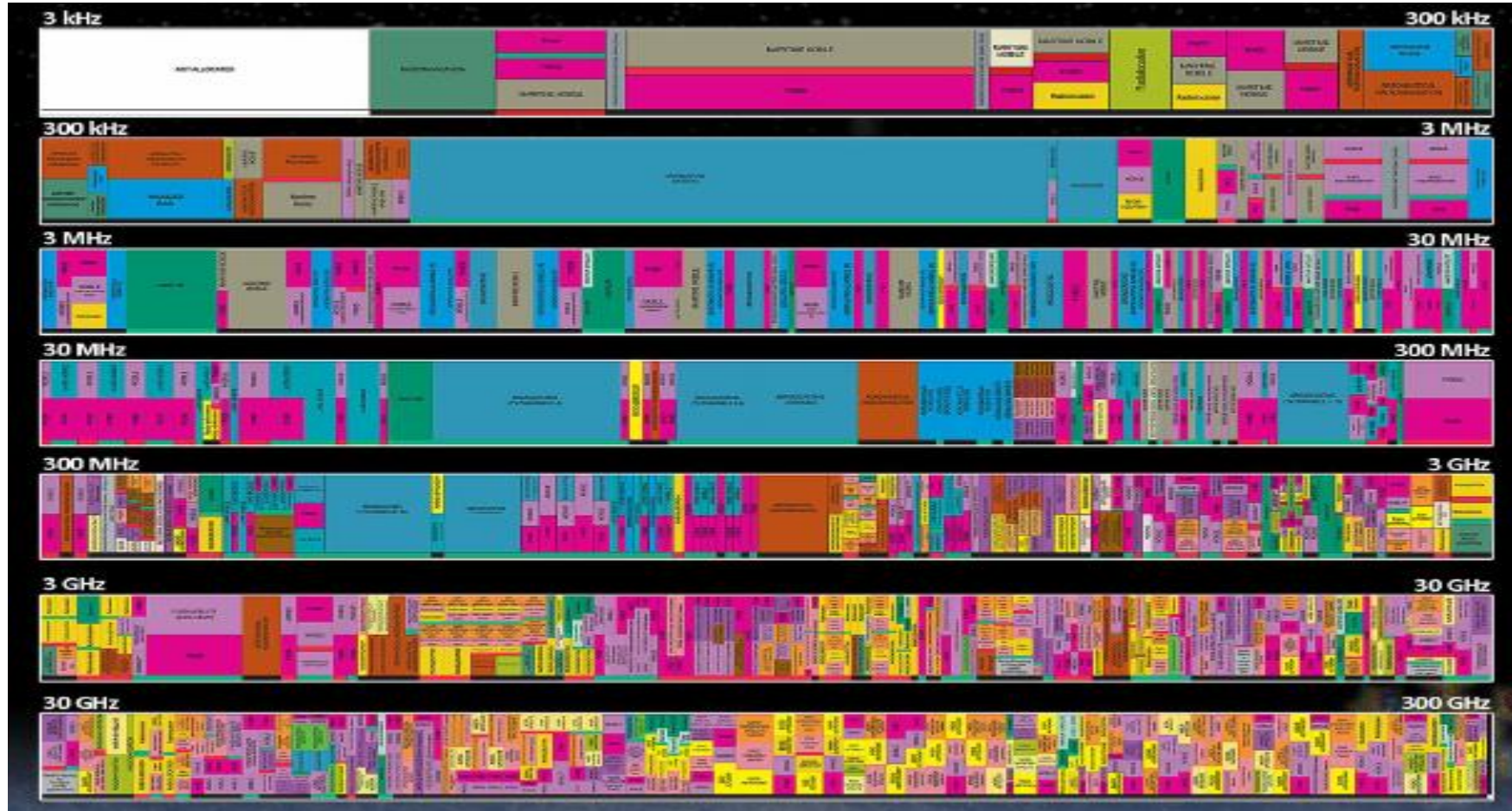

Growth of Mobile Phone Subscribers

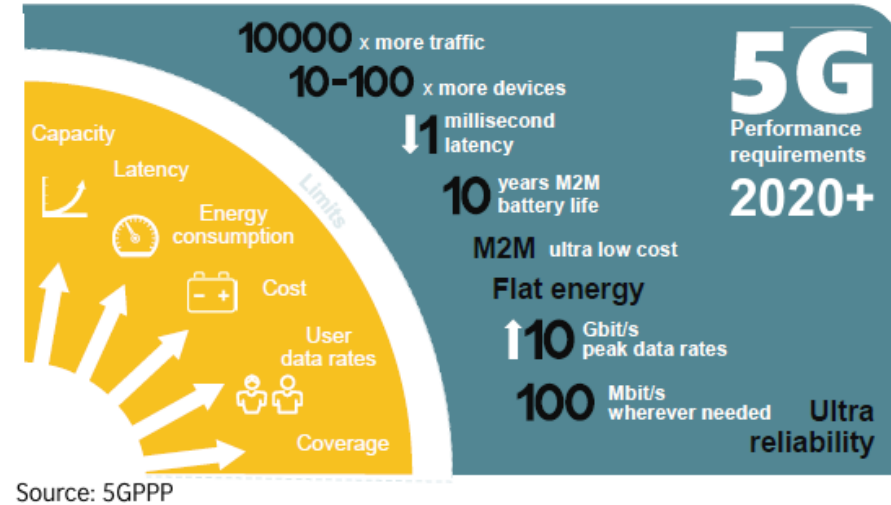
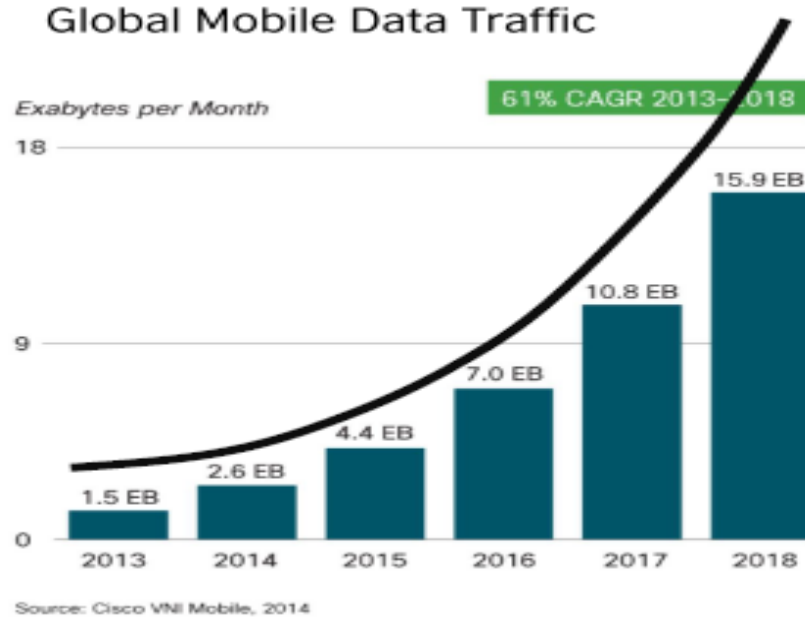

Mobile internet traffic is pushing the capacity limits of wireless networks !



RF Spectrum “Crunch”

- Smartphone usage tripled in 2011.
- Between 2011 and 2016, global wireless data traffic is expected to increase 18 times more.
- Rapid increase in the use of wireless services has lead the problems of RF spectrum *exhaustion* and eventually RF spectrum *deficit*.
- FCC predicts that the US would start experiencing a spectrum deficit for wireless communications at some point.



Potential Solution

- More efficient usage of the available spectrum:
 - Multiple antenna systems
 - Adaptive modulation and coding systems



Other Potential Solutions

- More aggressive temporal and spatial reuse of the available spectrum:
 - Cognitive radio systems
 - Femto cells & offloading solutions
- Use of unregulated bandwidth in the upper portion of the spectrum:
 - Microwave and millimeter-wave such as 60 GHz & 90 GHz
 - THz carriers
 - Optical spectrum



Optical Spectrum

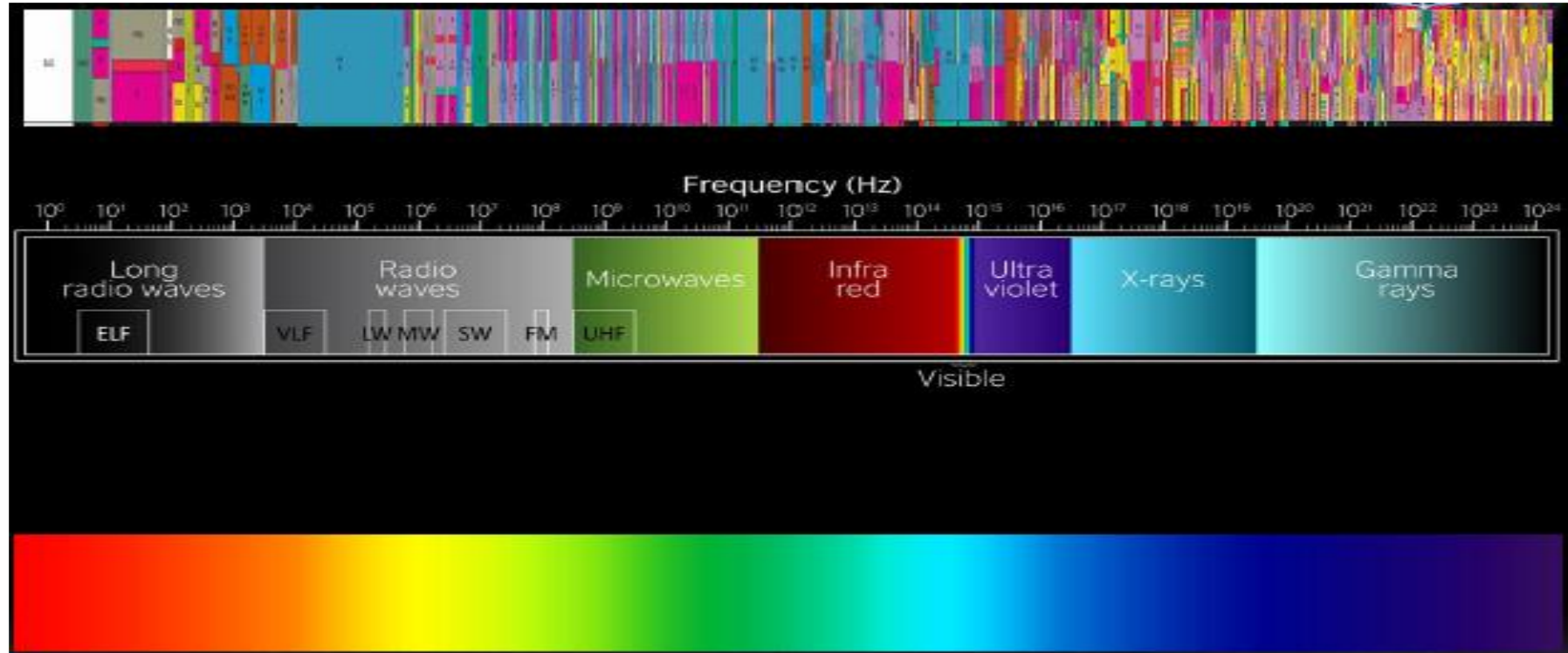

Visible spectrum is 10 thousands times larger than the RF spectrum !

Optical Wireless Communications

- Point-to-point free space optical communications (FSO)
- Visible light communications (know also as Li-Fi for Light-Fidelity)
- NLOS UV communication
- Underwater optical communication

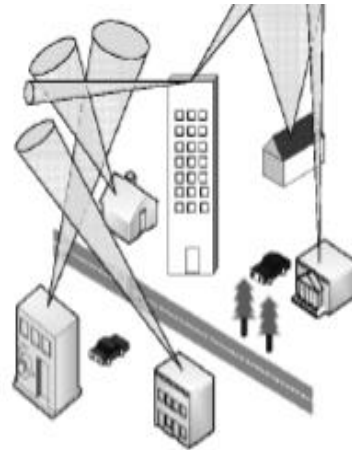

Free Space Optical (FSO) Communications

Towards the Speeds of Wireline Networks



Optical Transmission

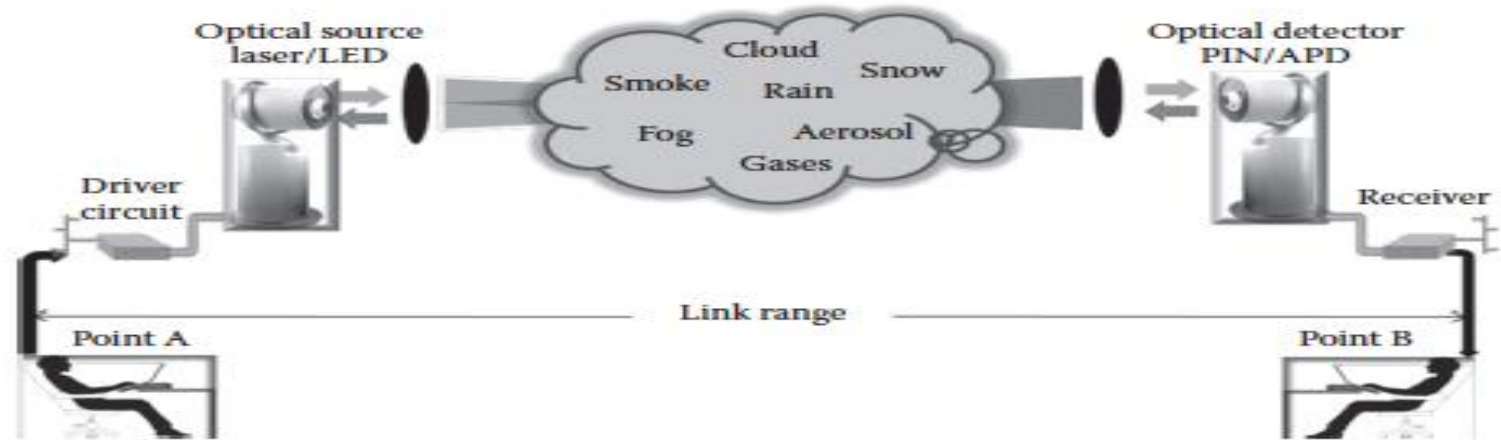

- **Optical Sources:** Light emitting diodes (LED) vs. Laser diodes (LD): output power, spectral width, E/O efficiency, Safety, Directionality, Reliability, and Cost)
- **Photodetectors:** P-i-N (PIN) vs. Avalanche (APD) photodiodes (Sensitivity, Cost, and Materials)

Transmission Windows

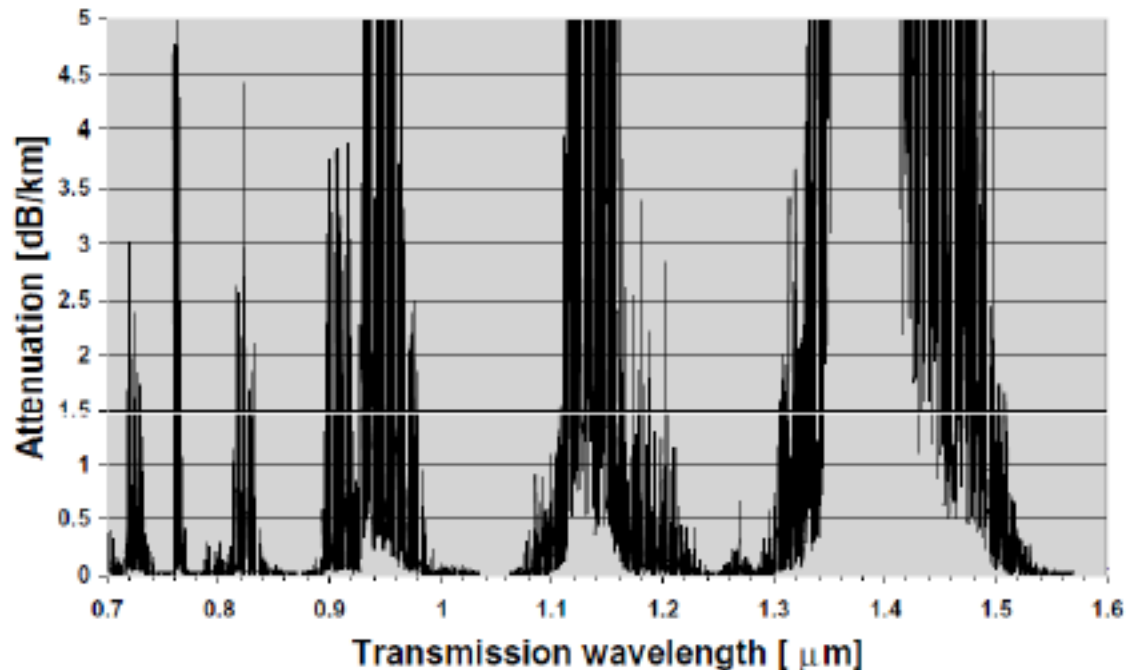

- Transmission optical windows in the IR region at: 850 nm, 1300 nm, & 1550 nm.
- Match optical fiber communication windows (compatibility of optical transceivers)
- Above 1400 nm, the eye is less sensitive to light

FSO Basic Principle

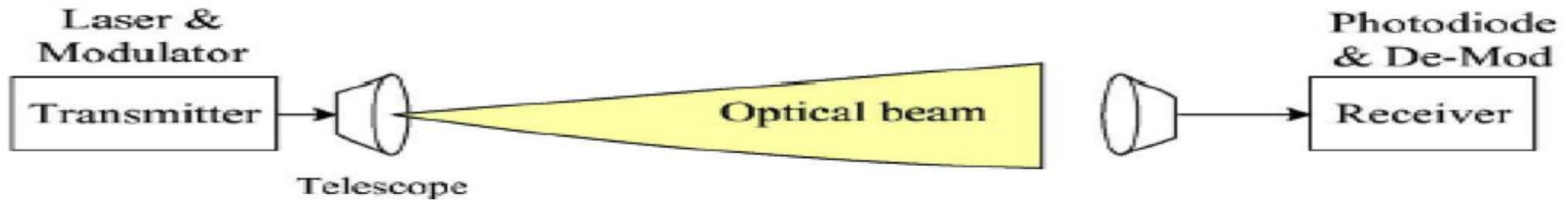

- Narrow beam connects two optical wireless transceivers in LOS.
- Light is transmitted from an optical source (laser or LED) through the atmosphere and received by a lens.
- Provides full-duplex (bi-directional) capability.
- 3 “optical windows”: 850 nm, 1300 nm, & 1550 nm.
- WDM can be used => 10 Gb/s (4x2.5 Gb/s) over 1 Km & 1.28 Tb/s (32x40 Gb/s) over 210 m.

Reference: M. Esmail, A. Ragheb, H. Fathallah, and M. -S. Alouini, "Experimental demonstration of outdoor 2.2 Tbps super-channel FSO transmission system", in Proc. Optical Wireless Communications Workshop in conjunction with Proceedings IEEE International Conference on Communications (ICC'2016), Kuala Lumpur, Malaysia, May 2016.

Types of Detection Techniques

- **Intensity Modulation/Direct Detection (IM/DD):** IM/DD is the main mode of detection in FSO systems. Does not require adaptive control systems.
- **Coherent Modulation/Heterodyne Detection (CM/HD):** *Heterodyne* detection is a more complicated detection method but has the ability to better overcome the thermal noise effects. Adaptive control is needed for the carrier phase and state of polarization.



Pointing Errors

- **Definition:** Thermal expansion, dynamic wind loads, and weak earthquakes result in the building sway phenomenon that causes vibration of the transmitter and the receiver known as pointing error.

Type	Cause(s)	Magnitude	Frequency
Tip/tilt	Thermal expansion	High	Once per day
Sway	Wind	Medium	Once every several seconds
Vibration	Equipment, door slamming, etc.	Low	Many times per second



Impact of Pointing Errors

- **Effect on Communication (ξ):** These pointing errors may lead to an additional performance degradation and are a serious issue in urban areas, where the FSO equipments are placed on high-rise buildings.
- **Model:** The pointing error model developed and parameterized by ξ which is **the ratio between the equivalent beam radius and the pointing error jitter** can be:
 - With Pointing Error: ξ is any number between 0 through 7
 - Without Pointing Error: ξ



Possible Solutions to the Pointing Errors Problem

- **Short Range FSO:** Increase the beam divergence at the expense of higher power loss.
- **Long Range FSO: Model:** Maintain narrow beam divergence but put in place a sophisticated pointing, acquisition, and tracking (PAT) system to solve the alignment problem in FSO:
 - Fixed tracking for short buildings
 - Active tracking for tall buildings



Atmospheric Losses

- Losses due to scattering for particles of size near the optical wavelength (Mie Scattering):
 - **Raindrops** and **snow** droplets are typically bigger than the FSO wavelengths.
 - **Fog** droplets are close in size to FSO wavelengths.
 - **Smog** (Gases and Smoke) may contain particle matters and water droplets
- Typical attenuation factors:
 - **Regular rain**: Low attenuation up to 9 dB/Km
 - **Snow**: Moderate attenuation up to 12 dB/Km
 - **Mist**: Moderate attenuation up to 12 dB/Km
 - **Heavy fog**: Strong attenuation of up to 200 dB/Km



Mitigating Atmospheric Losses

- Mesh architecture and route diversity
- Adaptive power control systems with feedback between receiver and transmitter
- Hybrid RF/FSO systems:
 - RF and FSO complement each others
 - Two modes of operations
 - Switch mode of operation
 - Joint usage mode of operation



Atmospheric Scintillations

- Intensity fluctuations (known as scintillations) are observed even in clear sky conditions and under perfect alignment conditions.
- Due to variation in temperature among air pockets which leads to a variation in the air refraction index along the propagation path.
- Characterized by the Kolmogorov atmospheric turbulence theory.



Characterization of Atmospheric Scintillations (1)

- The normalized variance of the irradiance is known as scintillation index:

$$\sigma_I^2 = E\{I^2\} / E\{I\}^2 - 1$$

- Relation between the scintillation index and the Rytov variance

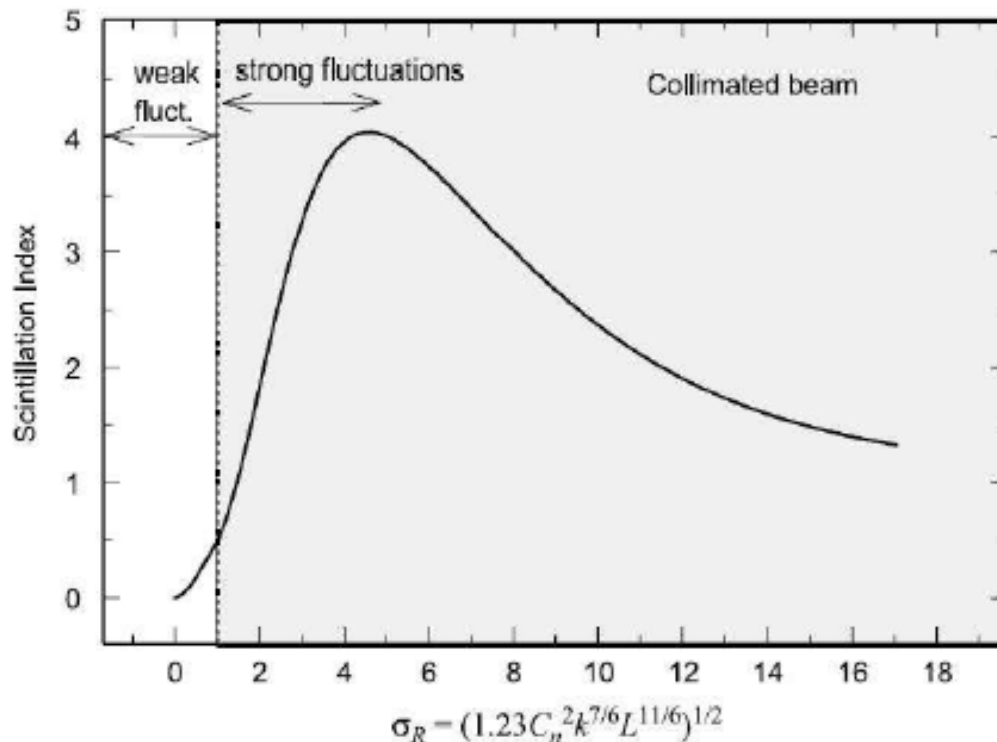

Characterization of Atmospheric Scintillations (2)

- Weak turbulence regime: $\sigma_R^2 \ll 1$; $\sigma_I^2 \approx \sigma_R^2$
- Moderate turbulence regime: $\sigma_R^2 \sim 1$
- Strong turbulence regime: $\sigma_R^2 \gg 1$



Atmospheric Scintillations Statistical Modelling

- Frequency flat fading channel
- Slow fading with coherence time: 10 μ s and 100 ms
- Popular statistical models:
 - Weak turbulence: Lognormal or Gamma-Gamma (Generalized K)
 - Strong turbulence: Exponential or Gamma-Gamma (Generalized K)
 - More generalized models: Double Gamma-Gamma or Malaga



Gamma-Gamma Model

- All regimes: weak, moderate, strong
- Small-scale irradiance fluctuations modulated by large-scale fluctuations

$$I = x y$$

x : large-scale turbulence, Gamma distributed
 y : small-scale turbulence, Gamma distributed

$$f(I) = \frac{2(\alpha\beta)^{(\alpha+\beta)/2}}{\Gamma(\alpha)\Gamma(\beta)} I^{\frac{(\alpha+\beta)}{2}-1} K_{\alpha-\beta}(2\sqrt{\alpha\beta I}), \quad I > 0$$

K_n : Bessel function of second kind and order n



Gamma-Gamma PDF

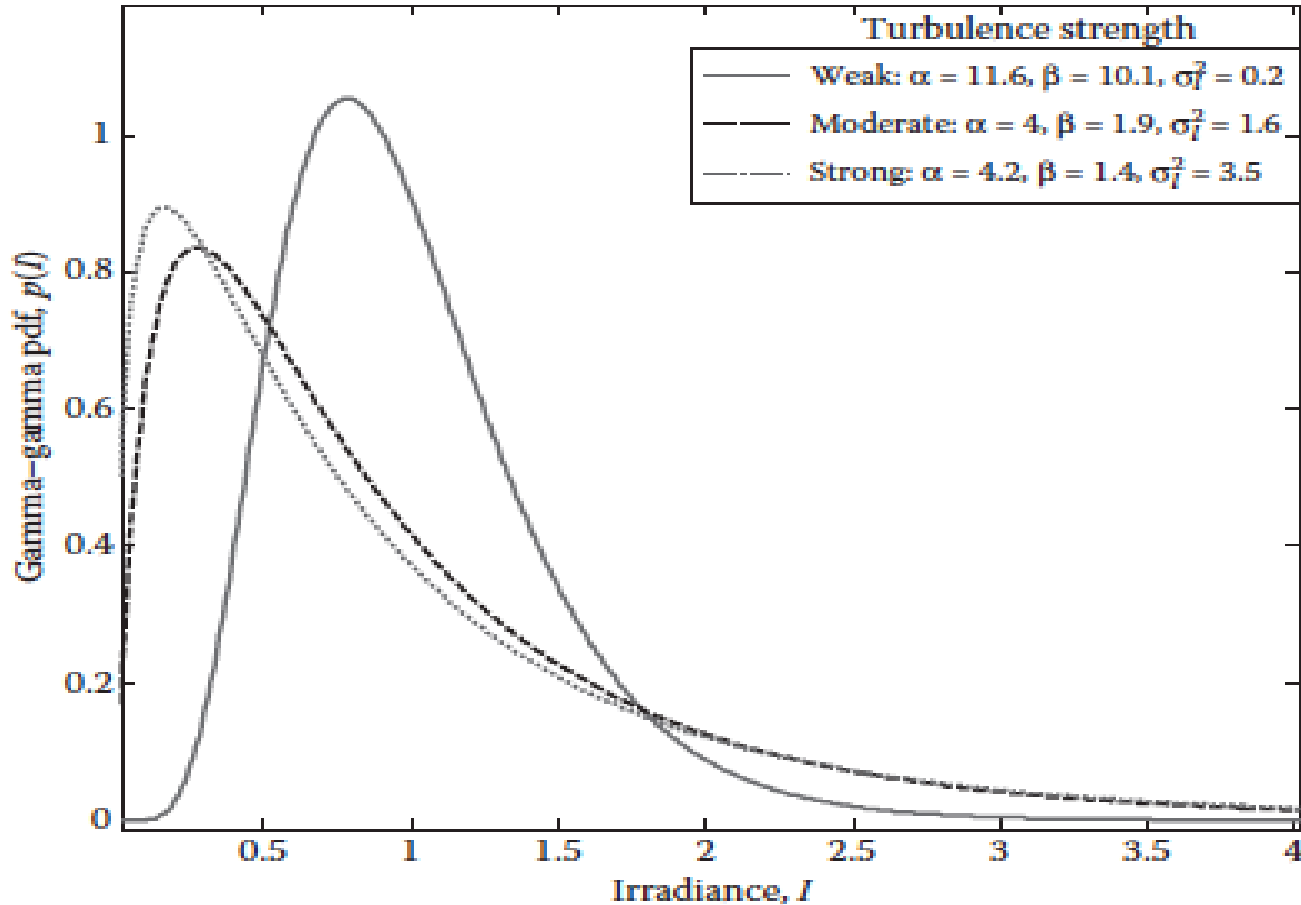

Mitigating Atmospheric Scintillations

- Time diversity (long delay and large buffer size)
- Frequency diversity (high correlation)
- Space diversity:
 - Aperture averaging
 - SIMO, MISO, and MIMO (multi-beam & multi-aperture) systems
- Cooperative diversity
 - Relay selection
 - Multiuser diversity
 - Multi-hop communication



Ergodic Capacity of OWC Channels

Asymptotic Results



Unified SNR Statistics

- Heterodyne Detection

$$\gamma = \eta_e I / N_0$$

$$\mu_{\text{heterodyne}} = \mathbb{E}_{\gamma_{\text{heterodyne}}}[\gamma] = \bar{\gamma}_{\text{heterodyne}} = \eta_e \mathbb{E}_I[I] / N_0$$

- IM/DD

$$\gamma = \eta_e^2 I^2 / N_0$$

$$\begin{aligned} \mu_{\text{IM/DD}} &= \mathbb{E}_{\gamma_{\text{IM/DD}}}[\gamma] \mathbb{E}_I^2[I] / \mathbb{E}_I[I^2] \\ &= \bar{\gamma}_{\text{IM/DD}} \mathbb{E}_I^2[I] / \mathbb{E}_I[I^2] = \eta_e^2 \mathbb{E}_I^2[I] / N_0 \end{aligned}$$

- Unified

$$\gamma_r = \eta_e^r I^r / N_0$$

$$\mu_r = \eta_e^r \mathbb{E}_I^r[I] / N_0$$

with irradiance $I = I_a I_p$



Asymptotic Ergodic Capacity

- Recall that the irradiance $I = I_a I_\rho$ and SNR γ is proportional to I'
- The asymptotic ergodic capacity can be obtained as [Yilmaz and Alouini, SPAWC'2012]

$$\bar{C} \underset{\gamma \gg 1}{\approx} \left. \frac{\partial}{\partial n} \mathbb{E}[\gamma^n] \right|_{n=0} = \left. \frac{\partial}{\partial n} \mathbb{E}[I_a^{rn}] \right|_{n=0} - \frac{2}{w_{z_{eq}}} \mathcal{M}'_{r,2}(0)$$

- We need to find the moments of I_a then compute derivatives.

Reference: I. Ansari, M. -S. Alouini, and J. Cheng, "On the capacity of FSO links under log-normal turbulence", Proceedings IEEE Vehicular Technology Conference (VTC Fall'2014), Vancouver, BC, Canada, September 2014. Journal version in IEEE Transactions on Wireless Communications, August 2015.



Exact Closed-Form Moments

- $I = I_a I_p = I_R I_L I_p$ where I_R , I_L , and I_p are independent random processes
- Unified Rician Moments

$$\mathbb{E} [I_R^{r n}] = \left[\Omega / (k^2 + 1) \right]^{r n} \Gamma (r n + 1) {}_1F_1 [-r n; 1; -k^2]$$

$$\begin{aligned} \mathbb{E} [\gamma_r^n] &= \eta_e^{r n} \mathbb{E} [I^{r n}] / N_0^n = \mu_r^n \mathbb{E} [(I_R I_L I_p)^{r n}] / \mathbb{E}^{r n} [I_R I_L I_p] \\ &= \mu_r^n \mathbb{E} [I_R^{r n}] \mathbb{E} [I_L^{r n}] \mathbb{E} [I_p^{r n}] / (\mathbb{E}^{r n} [I_R] \mathbb{E}^{r n} [I_L] \mathbb{E}^{r n} [I_p]) \end{aligned}$$

$$= \xi^{2(1-r n)} / \left[(\xi^2 + r n) (\xi^2 + 1)^{-r n} \right]$$

$$\times \exp \left\{ \frac{r n \sigma^2}{2} (r n - 1) \right\} \frac{{}_1F_1 [-r n; 1; -k^2]}{(1 + k^2)^{r n} \Gamma (r n + 1)^{-1}} \mu_r^n$$



Asymptotic Results

- High SNR

$$\bar{C} \underset{\mu_r \gg 1}{\approx} \ln \{c \mu_r\} - r \left[1/\xi^2 + \sigma^2/2 + \ln \{ \xi^2 / (\xi^2 + 1) \} \right. \\ \left. - \ln \{ k^2 / (1 + k^2) \} - E_1(k^2) \right]$$

- Low SNR

$$\bar{C} \underset{\mu_r \ll 1}{\approx} \frac{\xi^{2(1-r)}}{(\xi^2 + r)(\xi^2 + 1)^{-r}} \exp \left\{ \frac{r \sigma^2}{2} (r - 1) \right\} \\ \times (1 + k^2)^{-r} \Gamma(r + 1) {}_1F_1[-r; 1; -k^2] c \mu_r$$



Asymptotic Results

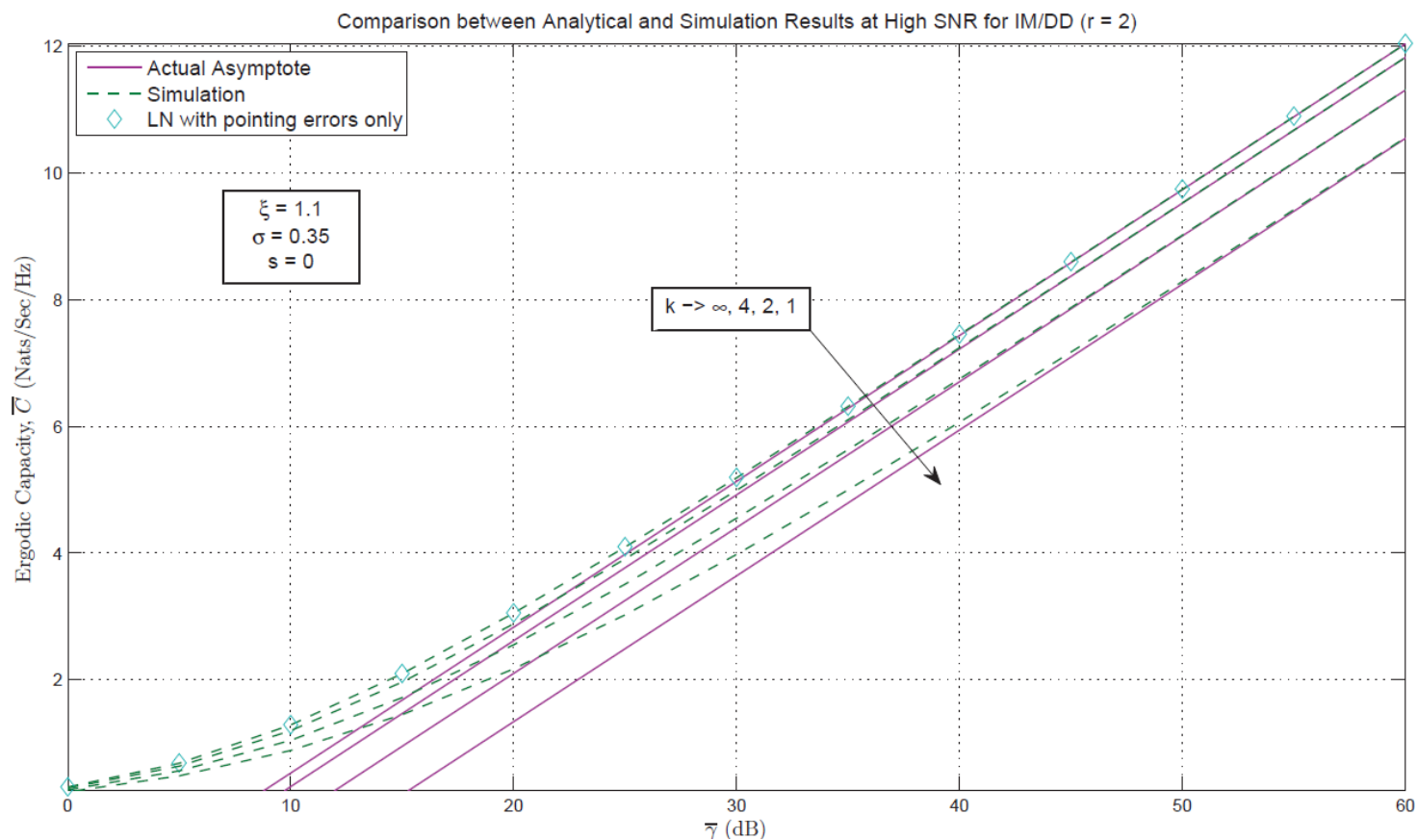

Figure: Ergodic capacity results for IM/DD technique and varying k at high SNR regime for RLN turbulence



Optical Wireless Backhauling

Impact of Pointing Errors

Impact of Pointing Errors

- **Effect on Communication:** These pointing errors may lead to an additional performance degradation and are a serious issue in urban areas, where the FSO equipments are placed on high-rise buildings.
- **Model:** The pointing error model developed and parameterized by ξ which is **the ratio between the equivalent beam radius and the pointing error jitter** can be:
 - With pointing error: ξ is between 0 and 7
 - Without pointing error: $\xi \rightarrow \infty$

Original Pointing Error Model

$$I = I_a I_p$$

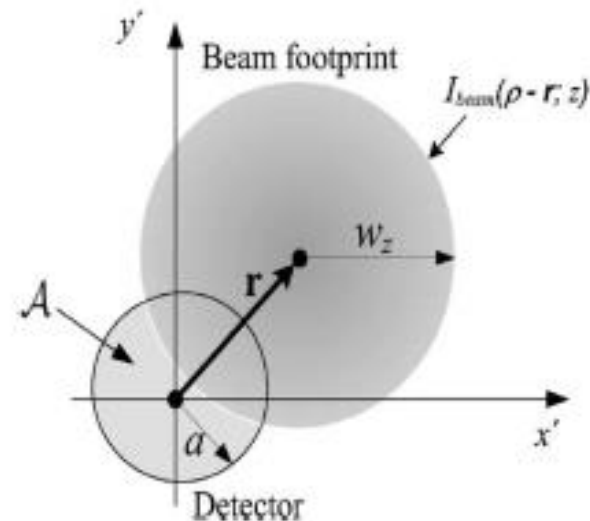

- The fraction of collected power at the receiver can be approximated by [Farid and Hranilovic, IEEE/OSA JLT 2007]

$$I_p \approx A_0 \exp\left(-\frac{2r^2}{w_{Zeq}^2}\right) \text{ where } \mathbf{r} = [x \ y]^t, \ r = \sqrt{x^2 + y^2}$$

Other Pointing Errors Models

- The general model reduces to special cases as follows

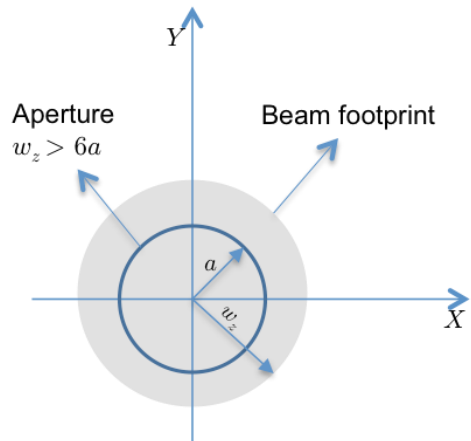

No misalignment

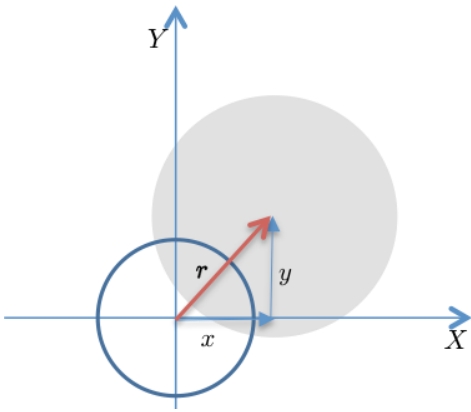

Figure : $\mu_x = \mu_y = 0$ and $\sigma_x^2 = \sigma_y^2$ (Rayleigh)

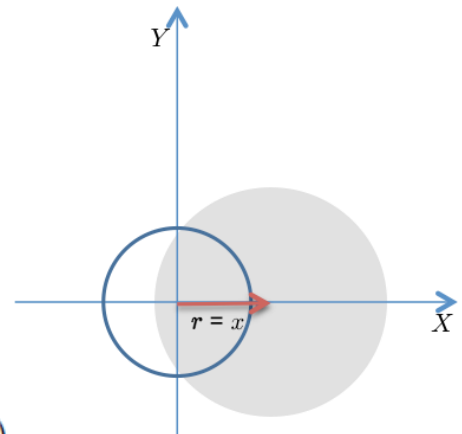

Figure : $\mu_x = \mu_y$ and $\sigma_y^2 = 0$ (Gaussian) .

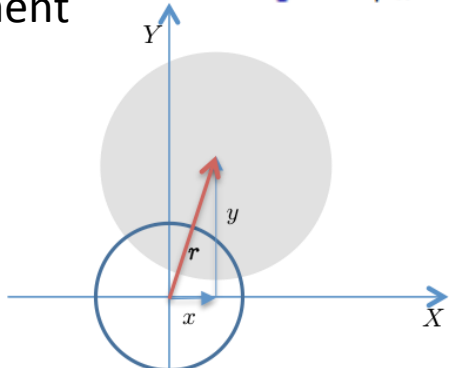

Figure : $\mu_x = \mu_y = 0$ and $\sigma_x^2 \neq \sigma_y^2$ (Hoyt).

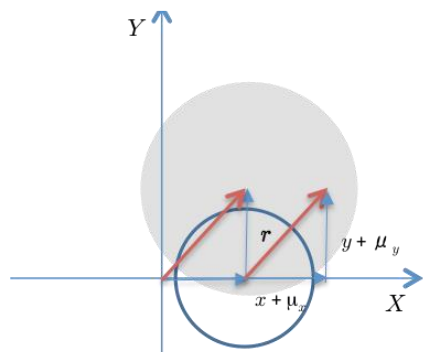

Figure : $\mu_x \neq \mu_y$ and $\sigma_x^2 = \sigma_y^2$ (Rician).

Generalized Pointing Error Model

- The fraction of collected power at the receiver can be approximated by [Farid and Hranilovic, IEEE/OSA JLT, 2007]

$$I_p \approx A_0 \exp\left(\frac{2r^2}{w_{z_{eq}}^2}\right), \text{ where } r = \sqrt{x^2 + y^2} \text{ and } x \sim \mathcal{N}(\mu_x, \sigma_x^2), \quad y \sim \mathcal{N}(\mu_y, \sigma_y^2)$$

$$f_r(r) = \frac{r}{2\pi\sigma_x\sigma_y} \int_0^{2\pi} \exp\left(-\frac{(r \cos \theta - \mu_x)^2}{2\sigma_x^2} - \frac{(r \sin \theta - \mu_y)^2}{2\sigma_y^2}\right) d\theta.$$

The random variable r follows a **Beckman** distribution

Moments of the Irradiance

$$\mathbb{E}[I_p^n] = \mathbb{E} \left[A_0^n \exp \left(-\frac{2nr^2}{w_{z_{eq}}^2} \right) \right] = A_0^n \mathcal{M}_{r^2} \left(-\frac{2n}{w_{z_{eq}}^2} \right)$$

$$\mathbb{E}[I_p^n] = \frac{A_0^n \xi_x \xi_y}{\sqrt{(n + \xi_x^2)(n + \xi_y^2)}} \exp \left(-\frac{2n}{w_{z_{eq}}^2} \left[\frac{\mu_x^2}{1 + \frac{n}{\xi_x^2}} + \frac{\mu_y^2}{1 + \frac{n}{\xi_y^2}} \right] \right),$$

where $\xi_x = \frac{w_{z_{eq}}}{2\sigma_x}$ and $\xi_y = \frac{w_{z_{eq}}}{2\sigma_y}$, are the ratio between the equivalent beam width and jitter variance for each direction.

$$\mathbb{E}[I^n] = \mathbb{E}[I_a^n] \mathbb{E}[I_p^n] = A_0^n \mathbb{E}[I_a^n] \mathcal{M}_{r^2} \left(-\frac{2n}{w_{z_{eq}}^2} \right).$$

$\mathcal{M}_{r^2}(\cdot)$ is the moment-generating function of the random variable r^2

Asymptotic Ergodic Capacity

- The asymptotic ergodic capacity can be obtained as

$$\bar{C} \underset{\bar{\gamma} \gg 1}{\approx} \frac{\partial}{\partial n} \mathbb{E}[\gamma^n] \Big|_{n=0} = \frac{\partial}{\partial n} \mathbb{E}[I_a^{rn}] \Big|_{n=0} - \frac{2}{w_{z_{eq}}} \mathcal{M}'_{r,2}(0)$$

- The moments of I_a are known for both lognormal (LN) and Gamma-Gamma ($\Gamma\Gamma$). Then, the asymptotic capacity can be written as

$$\begin{aligned} \bar{C}|_{\Gamma\Gamma} \underset{\bar{\gamma} \gg 1}{\approx} & \log \left(\frac{\sqrt{(r + \xi_x^2)(r + \xi_y^2)} \Gamma(\alpha) \Gamma(\beta)}{\xi_x \xi_y \Gamma(r + \alpha) \Gamma(r + \beta)} \bar{\gamma} \right) \\ & + \frac{2r}{w_{z_{eq}}^2} \left(\frac{\mu_x^2 \xi_x^2}{r + \xi_x^2} + \frac{\mu_y^2 \xi_y^2}{r + \xi_y^2} \right) - \frac{r}{2} \left(\frac{4(\mu_x^2 + \mu_y^2)}{w_{z_{eq}}^2} + \frac{1}{\xi_x^2} + \frac{1}{\xi_y^2} \right) + r\psi(\alpha) + r\psi(\beta) \end{aligned}$$

On-Going Research Directions: Ergodic Capacity Calculations under the impact of pointing errors

Asymptotic Ergodic Capacity

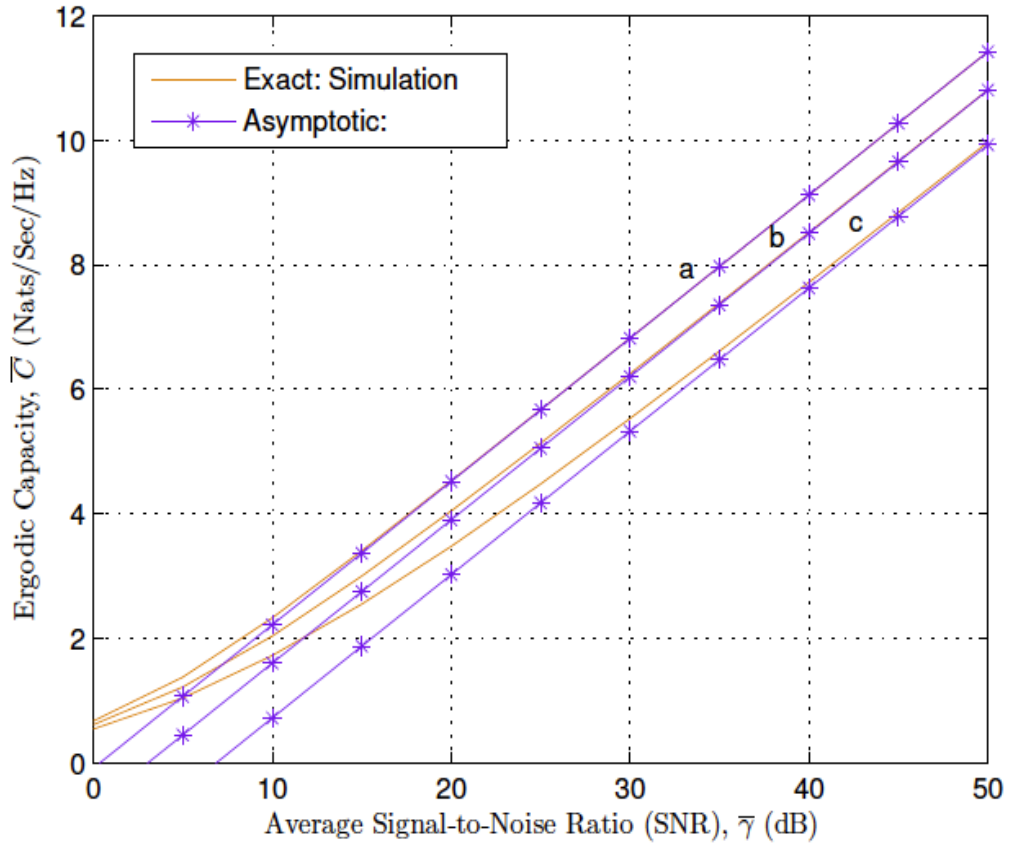

Figure: The ergodic capacity for:

- (a) $\xi_x = 6.7$ and $\xi_y = 5.1$
- (b) $\xi_x = 6.7$ and $\xi_y = 0.9$
- (c) $\xi_x = 0.8$ and $\xi_y = 0.9$

Reference: H. Al-Quwaiee, H.-C. Yang, and M. -S. Alouini, "On the asymptotic ergodic capacity of FSO Links with Generalized pointing error model", in Proceedings IEEE ICC'15, London, UK, June 2015. Journal version in IEEE Trans. Wireless Communications, Sept 2016.

Outage Capacity

- FSO channels are typically viewed as slowly varying channels => Coherence time is greater than the latency requirement
- Outage capacity is considered to be a more realistic metric of channel capacity for FSO systems
- Closed-form expressions are not possible => Importance sampling-based Monte Carlo simulations

C. Ben Issaid, K. -H. Park, R. Tempone, and M. -S. Alouini, "Fast outage probability simulation for FSO links with a generalized pointing error model", in Proc. IEEE Global Communications Conference (GLOBECOM'2016), Washington DC, December 2016.

Importance Sampling (IS)

$$P = \mathbb{P}(\gamma < \gamma_{\text{th}}) = \mathbb{P}(I = I_a \mid I_p < I_{\text{th}}) = \mathbb{P}(y_a + y_p < \varepsilon)$$

where $y_a = \log(I_a)$, $y_p = \log(I_p)$, and $\varepsilon = \log(I_{\text{th}})$

- IS estimator:

$$I^* = \frac{1}{N^*} \sum_{n=1}^{N^*} \mathbf{1}_{(y_{a,n}^* + y_{p,n}^* < \varepsilon)} w_{y_a}(y_{a,n}^*) w_{y_p}(y_{p,n}^*)$$

where $y_k^*(\cdot) \sim f_{y_k}^*(\cdot) = \frac{f_{y_k}(\cdot)}{w_{y_k}(\cdot)}$, $k = a, p$

IS Exponential Twisting

- Weighting Choice: $w_{y_k}(x) = e^{-\theta x} M_{y_k}(\theta)$

where $M_{y_k}(\cdot)$ is the MGF of y_k

- IS Estimator:

$$I^* = \frac{1}{N^*} \sum_{n=1}^{N^*} 1_{(y_{a,n}^* + y_{p,n}^* < \varepsilon)} e^{-\theta(y_{a,n}^* + y_{p,n}^*)} M_{y_a}(\theta) M_{y_p}(\theta)$$

$$\square M_{y_a}(\theta) = E[h_a^\theta] = \exp\left(\frac{1}{2} \theta(\theta - 1) \sigma_R^2\right) \text{ (LN fading)}$$

$$\square M_{y_a}(\theta) = E[h_a^\theta] = \frac{(\alpha\beta)^{-\theta} \Gamma(\alpha+\theta) \Gamma(\beta+\theta)}{\Gamma(\alpha) \Gamma(\beta)} \text{ (G-G fading)}$$

$$\square M_{y_p}(\theta) = E[h_p^\theta] = \frac{\xi_x \xi_y A_0^\theta \exp\left(-\frac{2\theta}{w_{zeq}^2} \left[\frac{\mu_x^2 \xi_x^2}{\xi_x^2 + \theta} + \frac{\mu_y^2 \xi_y^2}{\xi_y^2 + \theta} \right]\right)}{\sqrt{(\xi_x^2 + \theta)(\xi_y^2 + \theta)}}$$

Optimal θ

- Minimization problem:

$$\min_{\theta} E \left[1_{(y_a + y_p < \epsilon)} w_{y_a}^2(y_a, \theta) w_{y_p}^2(y_a, \theta) \right]$$

→ Stochastic optimization problem: Not feasible analytically except for a few simple cases.

→ Alternative: Find a sub-optimal θ :

– Cumulant generating function:

$$\mu(\theta) = \log \left(E \left[e^{\theta(y_a + y_p)} \right] \right) = \log(M_a(\theta)) + \log(M_p(\theta))$$

– Sub-optimal θ :

$$\mu'(\theta) = \epsilon$$

Sub-Optimal θ

- Weak turbulence:

$$\log(A_0) + \frac{\sigma_R^2}{2} (2\theta - 1) - \frac{\xi_x^2 + \xi_y^2 + 2\theta}{2(\xi_x^2 + \theta)(\xi_y^2 + \theta)} - \frac{2\theta}{w_{zeq}^2} \left[\frac{\mu_x^2 \xi_x^4}{(\xi_x^2 + \theta)^2} + \frac{\mu_y^2 \xi_y^4}{(\xi_y^2 + \theta)^2} \right] = \epsilon$$

- Strong turbulence:

$$\log\left(\frac{A_0}{\alpha\beta}\right) - \frac{\xi_x^2 + \xi_y^2 + 2\theta}{2(\xi_x^2 + \theta)(\xi_y^2 + \theta)} - \frac{2\theta}{w_{zeq}^2} \left[\frac{\mu_x^2 \xi_x^4}{(\xi_x^2 + \theta)^2} + \frac{\mu_y^2 \xi_y^4}{(\xi_y^2 + \theta)^2} \right] + \psi(\alpha + \theta) + \psi(\beta + \theta) = \epsilon$$

where $\psi(x) = \frac{\Gamma'(x)}{\Gamma(x)}$

Outage Probability

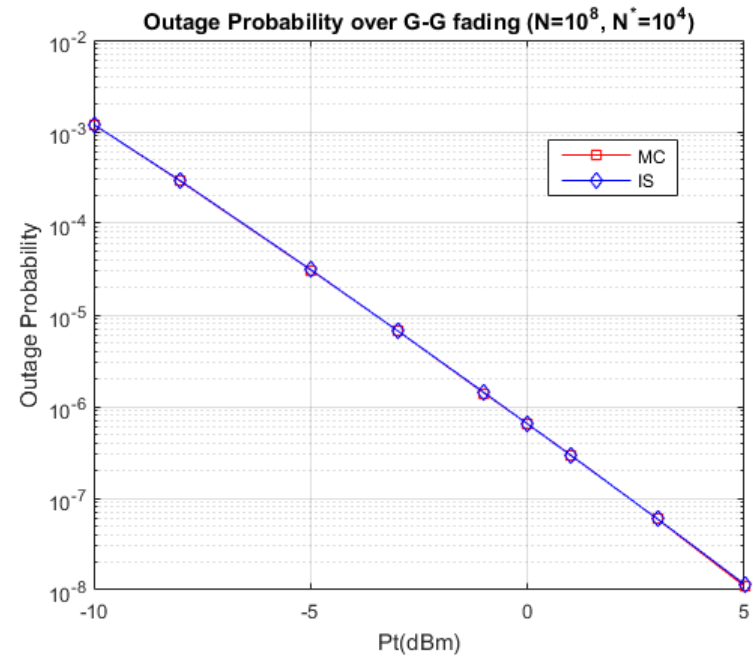
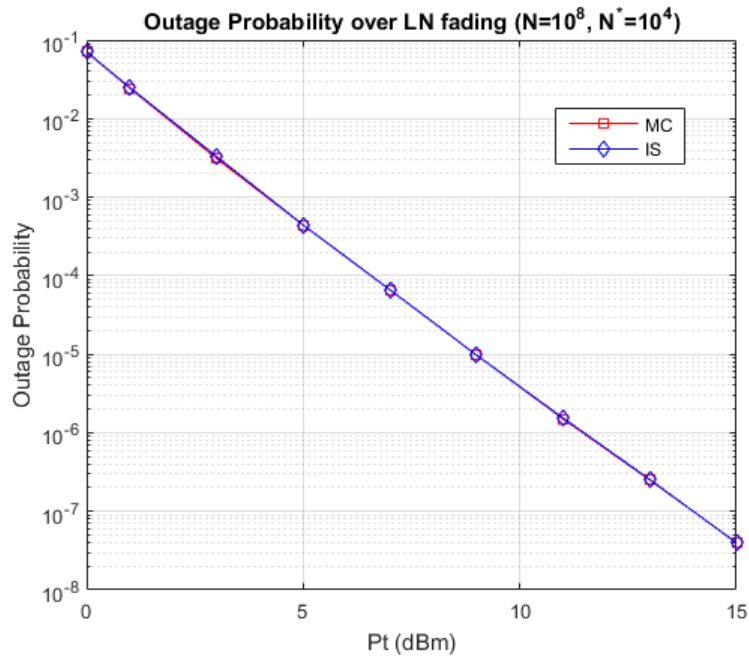

Efficiency Indicator

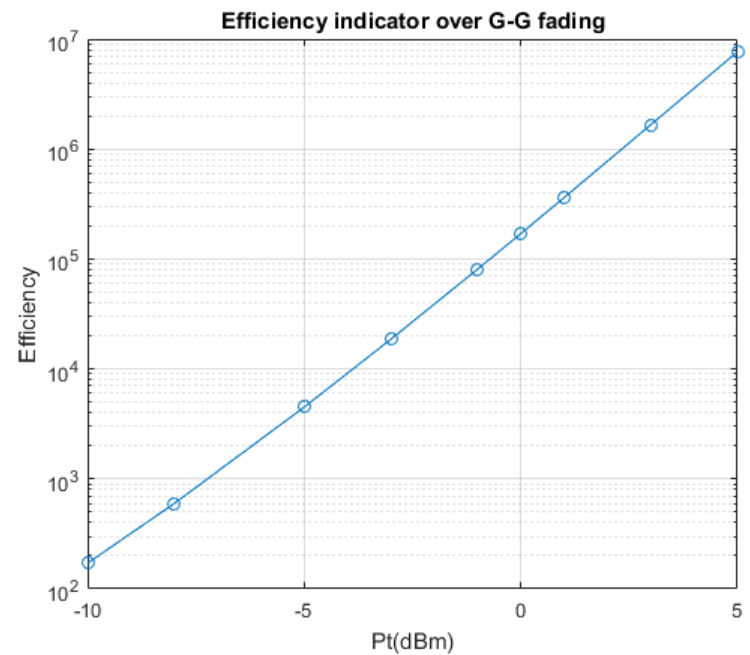
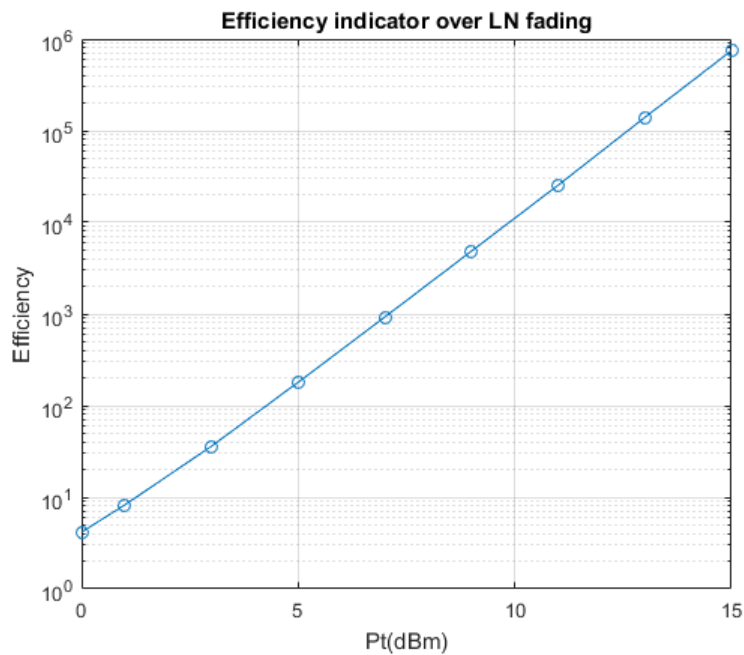

Impact of Jitter Unbalance on Outage Probability

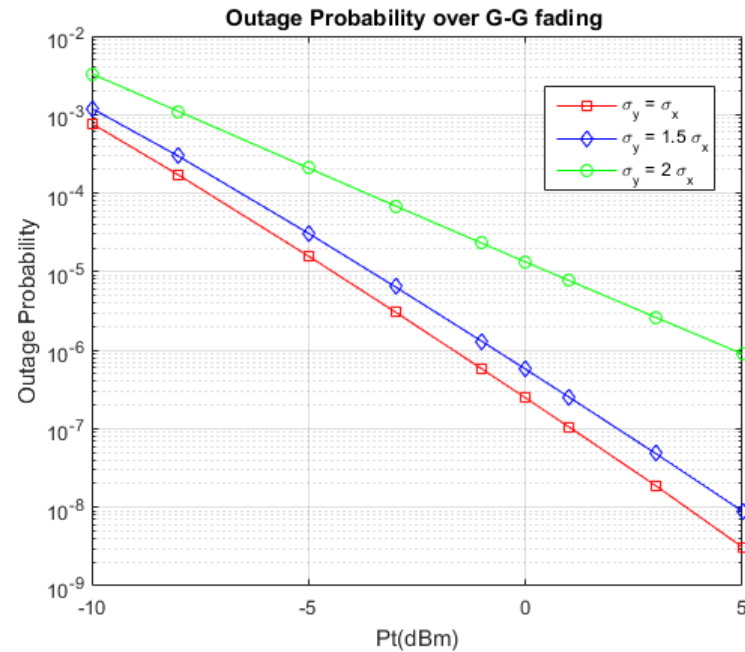
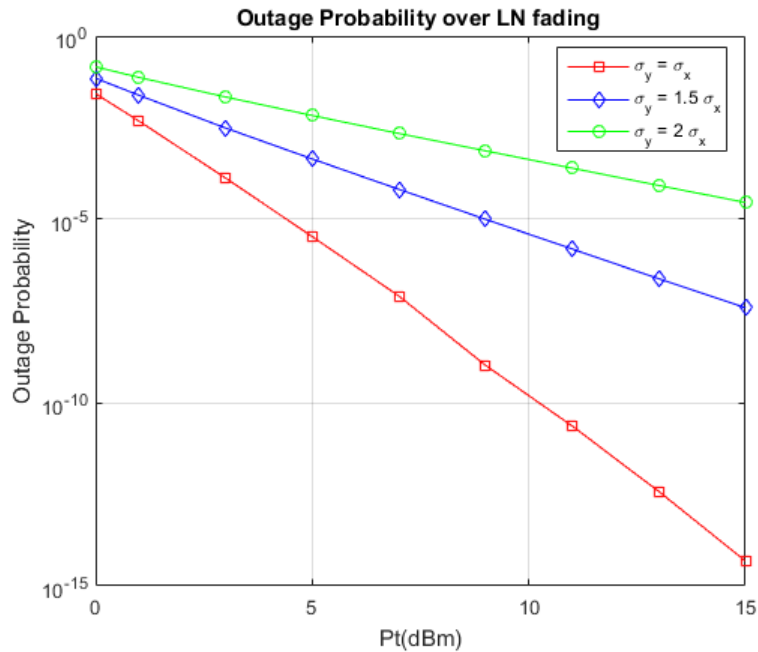

Positioning, Acquisition, and Tracking (PAT) for FSO Links

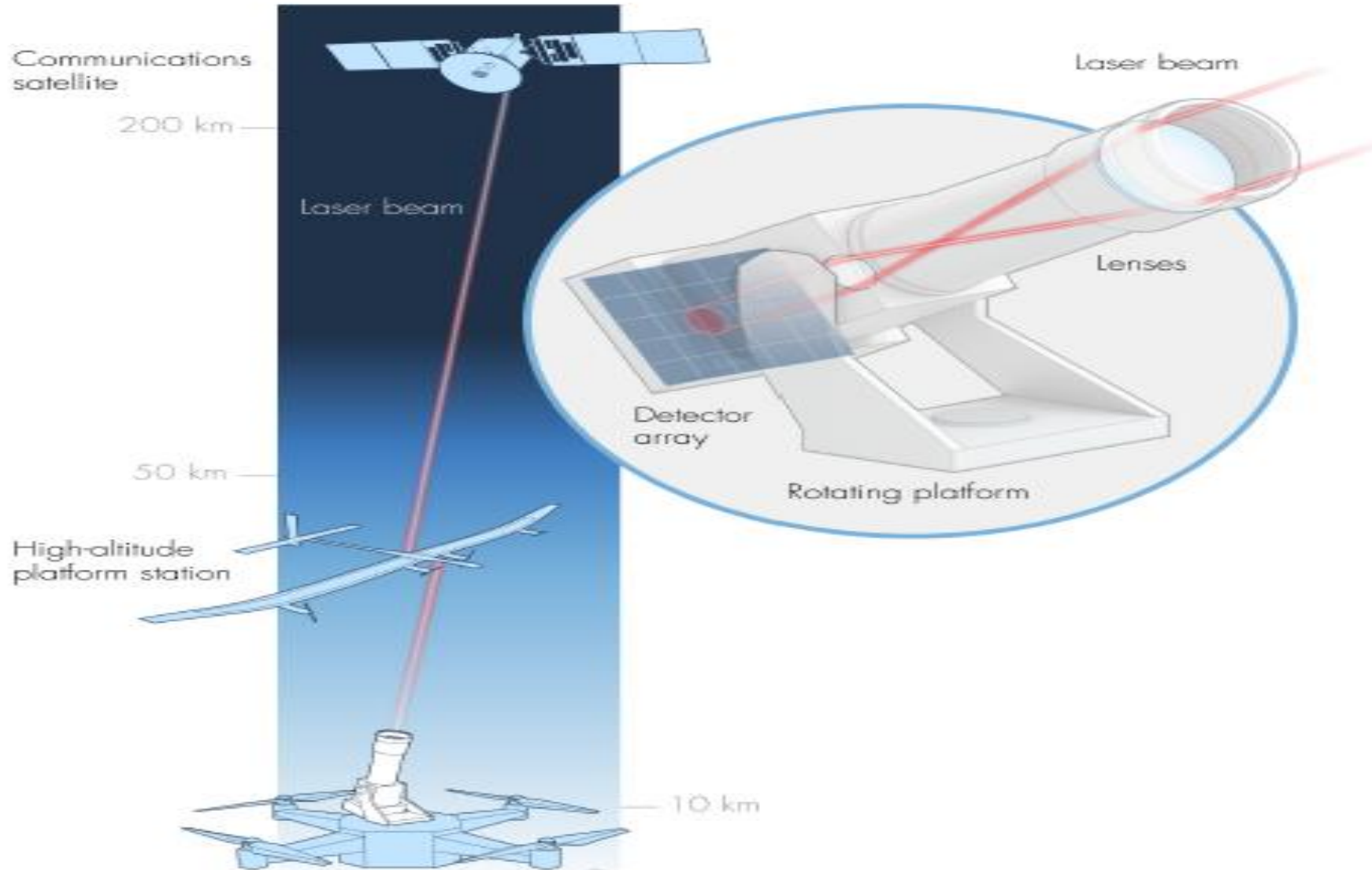



A Single Detector vs. An Array of Detectors

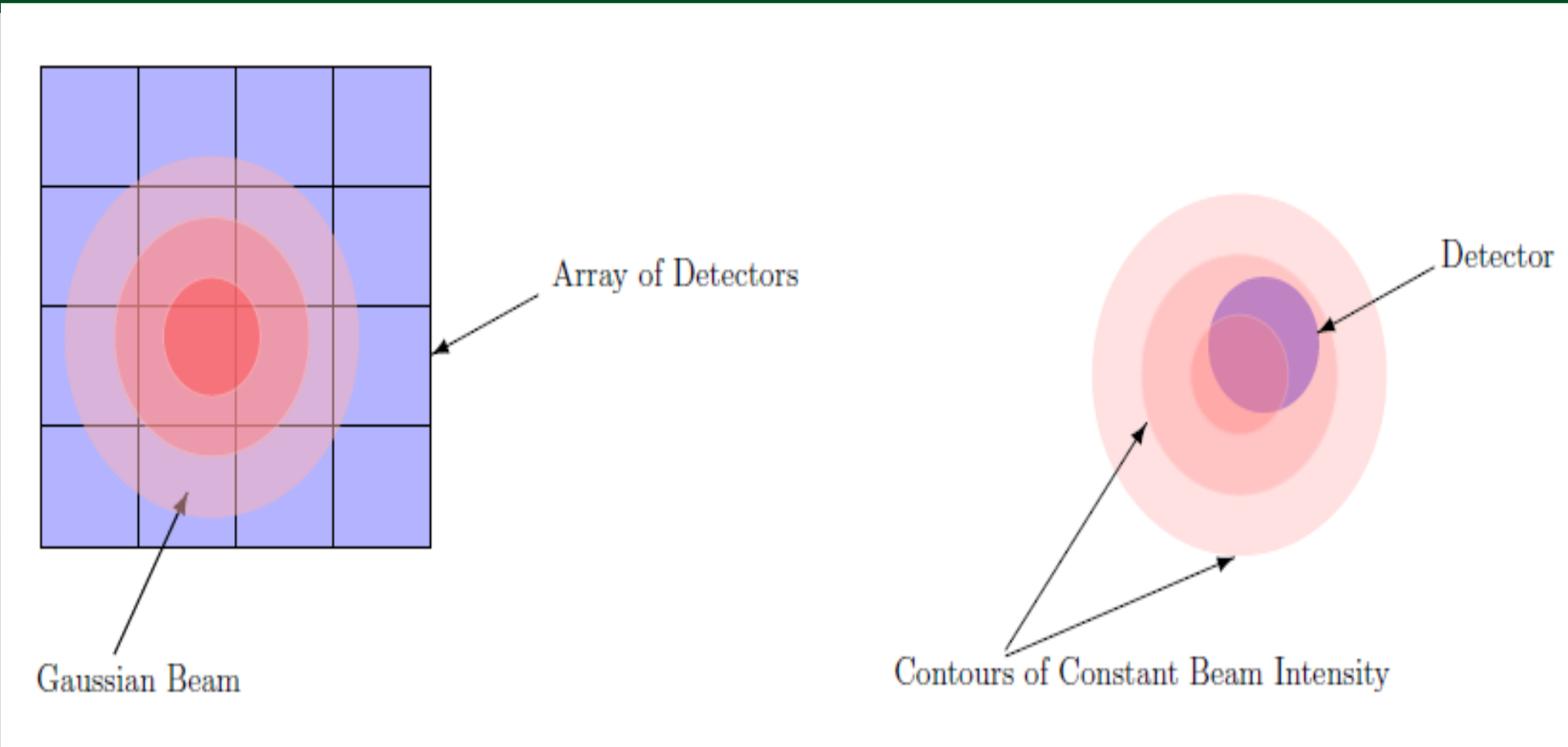

M. S. Bashir and M. -S. Alouini, "Signal acquisition with photon-counting detector arrays in free-space optical communications ", IEEE Transactions on Wireless Communication, Vol. 19, No. 4, pp. 2181-2195, April 2020.

Gaussian Beam on the Detector Array

- The Gaussian beam on the photosensitive detector array is characterized as

$$\lambda_s(x, y, z) \triangleq I_0 \exp\left(\frac{-(x - x_0)^2 - (y - y_0)^2}{2\rho^2(z)}\right).$$

- The number of photons in the m th detector are modeled by a Poisson random variable

$$P(\{Z_m = z_m\}) = \frac{\exp\left(-\iint_{A_m} K[\lambda_s(x, y, z) + \lambda_n] dx dy\right) \left(\iint_{A_m} [K(\lambda_s(x, y, z) + \lambda_n)] dx dy\right)^{z_m}}{z_m!}.$$

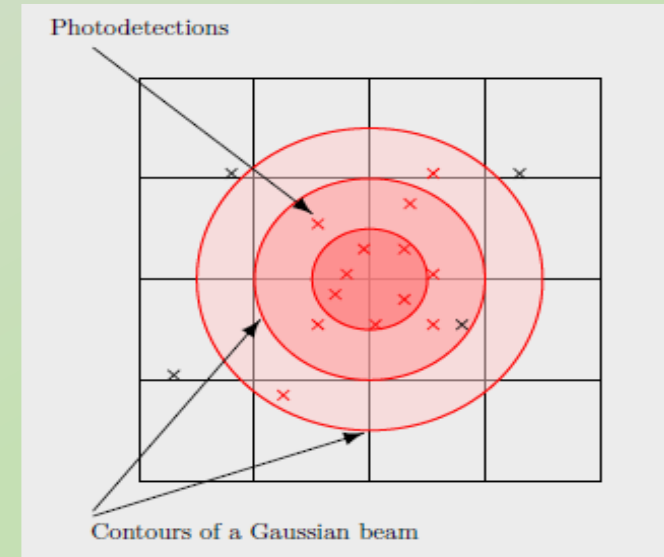

Maximum Likelihood Detector (1)

- Two hypotheses:

H_0 : There is no signal pulse on the detector array

H_1 : There is a signal pulse on the detector array

$$\frac{P(\mathbf{Z}|H_1)}{P(\mathbf{Z}|H_0)} \underset{H_1}{\overset{H_0}{\lesseqgtr}} \gamma \implies \frac{p_1(z_1, z_2, \dots, z_M)}{p_0(z_1, z_2, \dots, z_M)} \underset{H_1}{\overset{H_0}{\lesseqgtr}} \gamma.$$

$$p_0(z_1, z_2, \dots, z_M) = \prod_{m=1}^M \frac{(\lambda_n A)^{z_m} e^{-\lambda_n A}}{z_m!}$$

$$p_1(z_1, z_2, \dots, z_M) = \prod_{m=1}^M \frac{(\Lambda_m)^{z_m} e^{-\Lambda_m}}{z_m!},$$

where $A \triangleq |A_m|$ and

$$\Lambda_m \triangleq \iint_{A_m} \left(I_0 e^{\frac{-(x-x_0)^2 - (y-y_0)^2}{2\rho^2(z)}} + \lambda_n \right) dx dy.$$

Maximum Likelihood Detector (2)

- The likelihood ratio for this detection problem is:

$$\sum_{m=1}^M z_m \ln \left(1 + \frac{1}{\lambda_n A} \iint_{A_m} I_0 e^{\frac{-(x-x_0)^2 - (y-y_0)^2}{2\rho^2(z)}} dx dy \right)$$

$\underbrace{\hspace{15em}}_{\alpha_m}$

$$\underbrace{\sum_{H_0}^{H_1} \ln(\gamma) + \iint_C I_0 e^{\frac{-(x-x_0)^2 - (y-y_0)^2}{2\rho^2(z)}} dx dy}_{\gamma_0}$$

- Optimum decision rule

$$\sum_{m=1}^M z_m \alpha_m \underset{H_1}{\overset{H_0}{\gtrless}} \gamma_0.$$

Probability of Missed Detection

- The probability of missed detection is

$$P_m \triangleq P\left(\left\{\sum_{m=1}^M Z_m \alpha_m < \gamma_0\right\}\right),$$

$$\text{where } Z_m \sim \text{Poisson}\left(\iint_{A_m} \left(I_0 e^{\frac{-(x-x_0)^2 - (y-y_0)^2}{2\rho^2(z)}} + \lambda_n\right) dx dy\right)$$

- The probability of missed detection can be approximated by [Fay and Feuer'1997]

$$P_m = P\left(\left\{\sum_{m=1}^M Z_m \alpha_m < \gamma_0\right\}\right) \approx P(\{Z_0 < k\gamma_0\}),$$

$$= Q(\lfloor k_s \gamma_0 + 1 \rfloor, k_s \mu_s),$$

$$k_s \triangleq \frac{\mu_s}{\sigma_s^2}$$

$$Q(x, y) \triangleq \frac{\Gamma(x, y)}{\Gamma(x)}.$$

$\Gamma(x, y)$ is the upper incomplete gamma function:

$$\Gamma(x, y) \triangleq \int_y^\infty t^{x-1} e^{-t} dt, \quad \Gamma(x) \triangleq \int_0^\infty t^{x-1} e^{-t} dt.$$

Comparison of Approximations

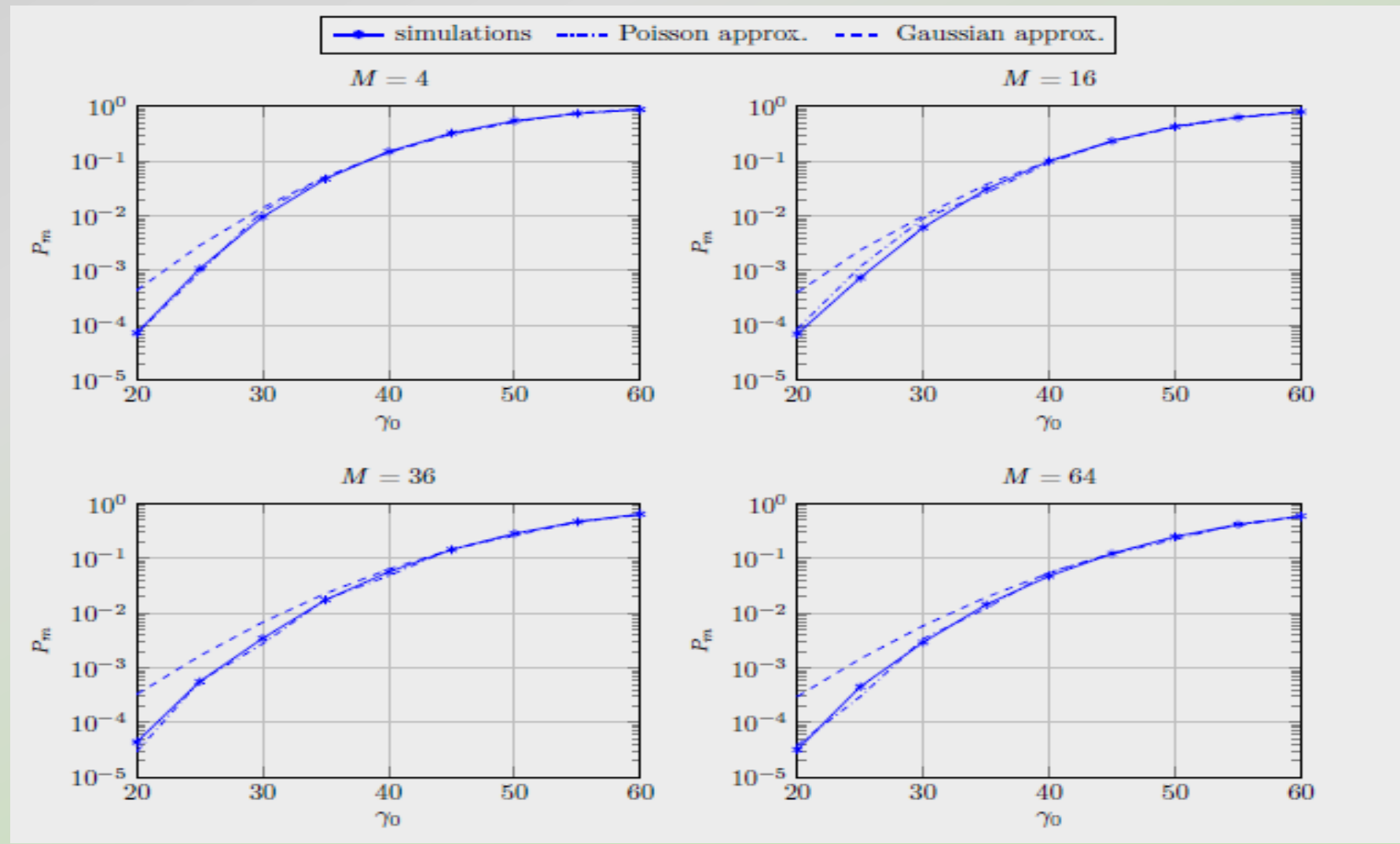



Dependence on the Beam Center

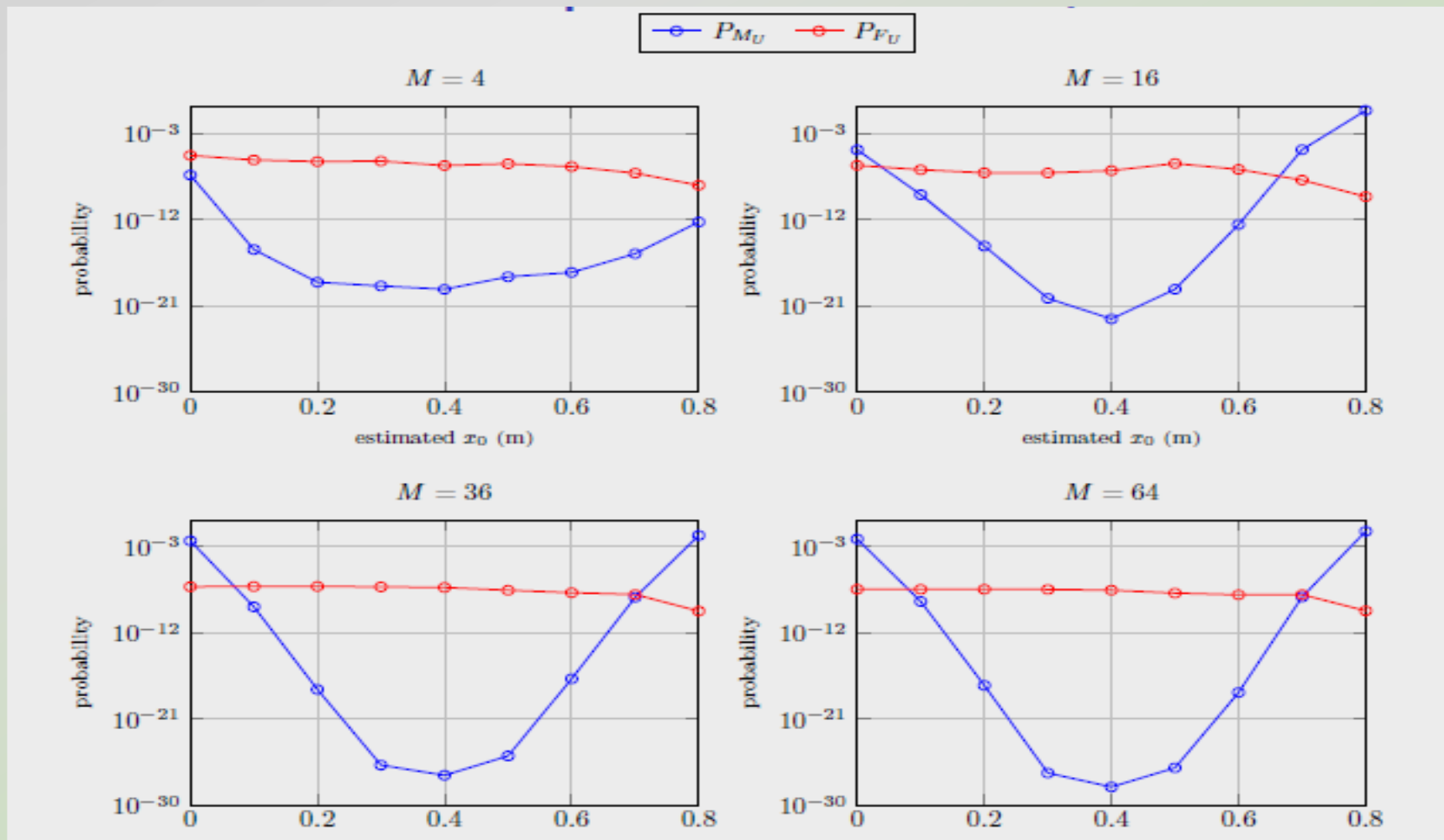

Effect of Beam Radius

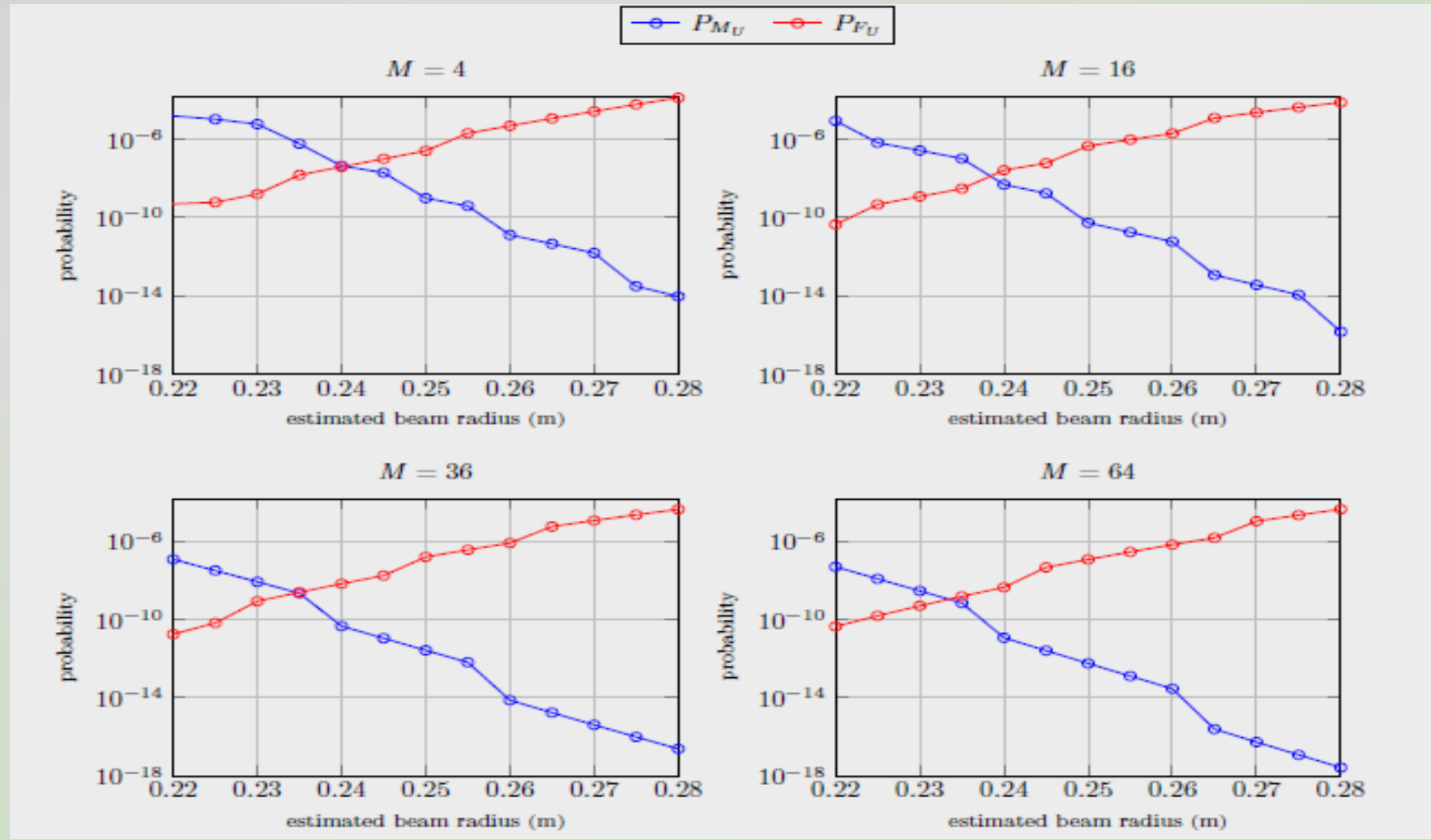

Acquisition Time

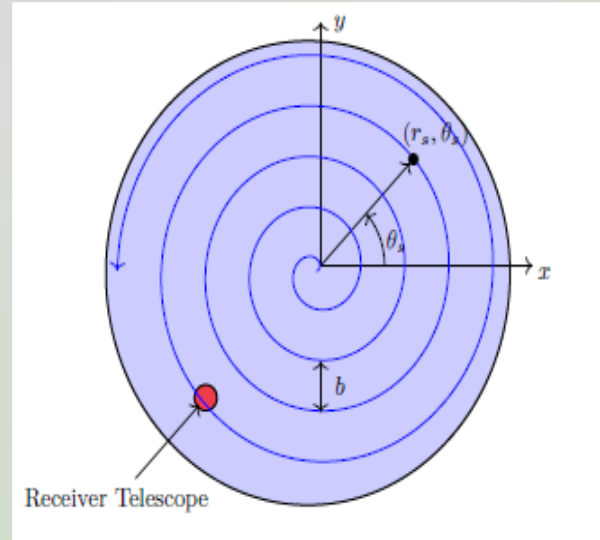

Total acquisition time: $T_u = T_s X + T_d W = Y+V$

- T_s : Scan time
- X : Number of "failed" attempts
- T_d : Dwell time
- W : fraction of time in last "successful" attempt

Distribution of W

$$W \triangleq \frac{\pi R^2}{\pi \rho^2(z)} = \frac{R^2}{\rho^2(z)}$$

- ▶ It can be shown that the density function of W is

$$f_W(w) = \frac{\rho^2(z)}{2\sigma_0^2} \exp\left(-\frac{\rho^2(z)}{2\sigma_0^2} w\right) \cdot \mathbb{1}_{[0, \infty)}(w)$$

where W is an *exponential* random variable with

$$\mathbb{E}[W] = \frac{2\sigma_0^2}{\rho^2(z)}$$



Acquisition Time Performance

$$f_Y(y) = \sum_{k=0}^{\infty} p^k (1-p) \delta(y - kT_s),$$

$$f_{T_U}(t) = f_Y(y) * f_V(v).$$

Complementary Cumulative Distribution Function of Acquisition Time

$$P(\{T_U > \gamma\}) = (1-p) \left(\exp(-\beta\gamma) \times \frac{1 - (p \exp(\beta T_s))^{\lceil \frac{\gamma}{T_s} \rceil}}{1 - p \exp(\beta T_s)} + \frac{p \lceil \frac{\gamma}{T_s} \rceil}{1-p} \right)$$

with

$$\beta \triangleq \frac{\rho^2}{2T_d \sigma_0^2}$$

Asymptotic Acquisition Time Performance

$$P(\{T_U > \gamma\}) = (1 - p) \left(\underbrace{\exp(-\beta\gamma) \times \frac{1 - (p \exp(\beta T_s))^{\lceil \frac{\gamma}{T_s} \rceil}}{1 - p \exp(\beta T_s)}}_{\text{Term 1}} + \underbrace{\frac{p^{\lceil \frac{\gamma}{T_s} \rceil}}{1 - p}}_{\text{Term 2}} \right), \quad (4)$$

- ▶ When $p \rightarrow 0$, $P(\{T_U > \gamma\}) = \exp(-\beta\gamma)$. This is easy to see because for $p = 0 \implies P(\{Y = 0\}) = 1 \implies T_U = V$ which is exponentially distributed. In other words, we never do a rescan of uncertainty region.
- ▶ When $p \rightarrow 1$, then Term 1 can be ignored compared to Term 2 and $P(\{T_U > \gamma\}) \rightarrow 1$ for any finite γ . In other words, $p \rightarrow 1 \implies T_U \rightarrow \infty$.

Acquisition Time as Function of Noise Power and Beam Radius

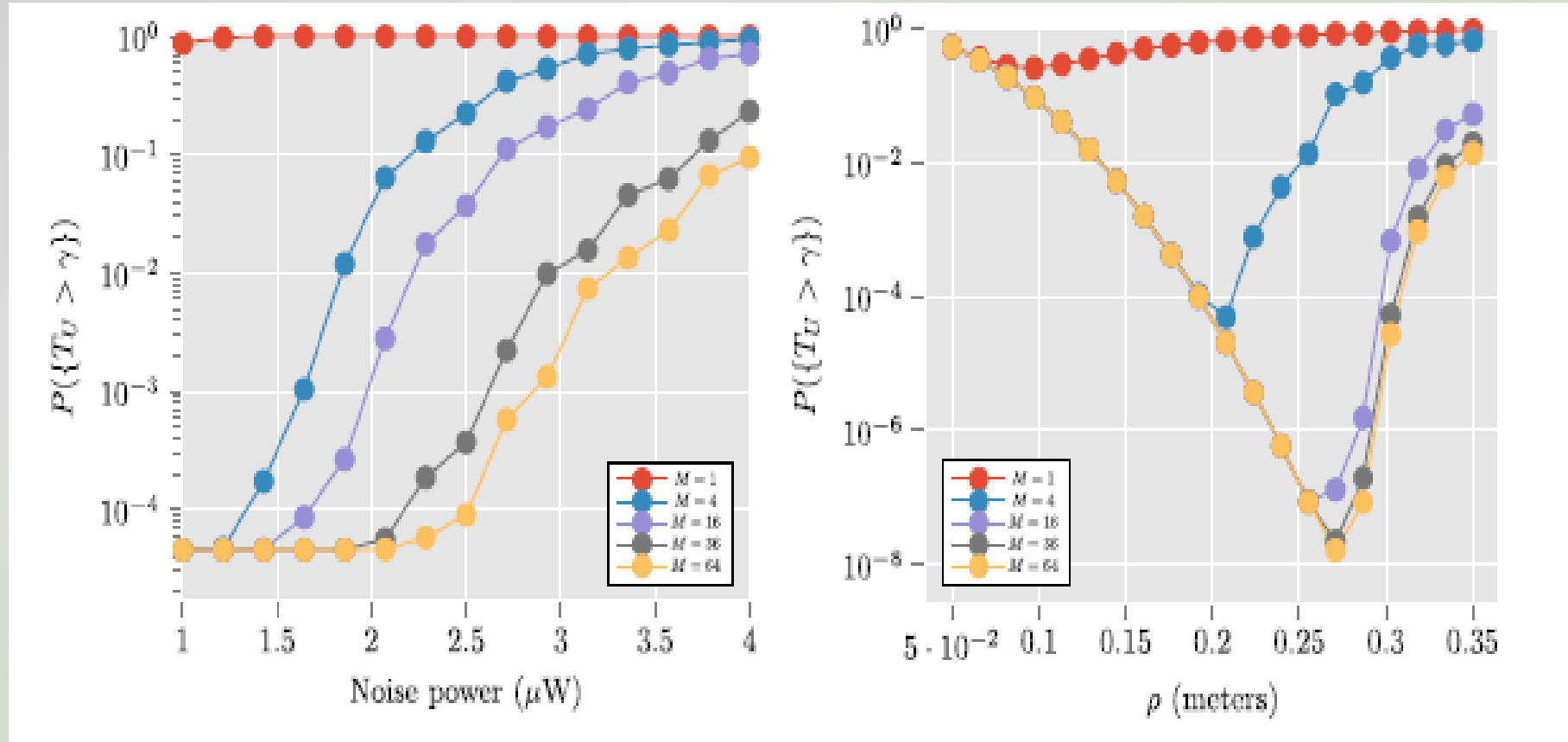

M. S. Bashir and M. -S. Alouini, "Signal acquisition with photon-counting detector arrays in free-space optical communications ", IEEE Transactions on Wireless Communication, Vol. 19, No. 4, pp. 2181-2195, April 2020.

Probability of Error Performance

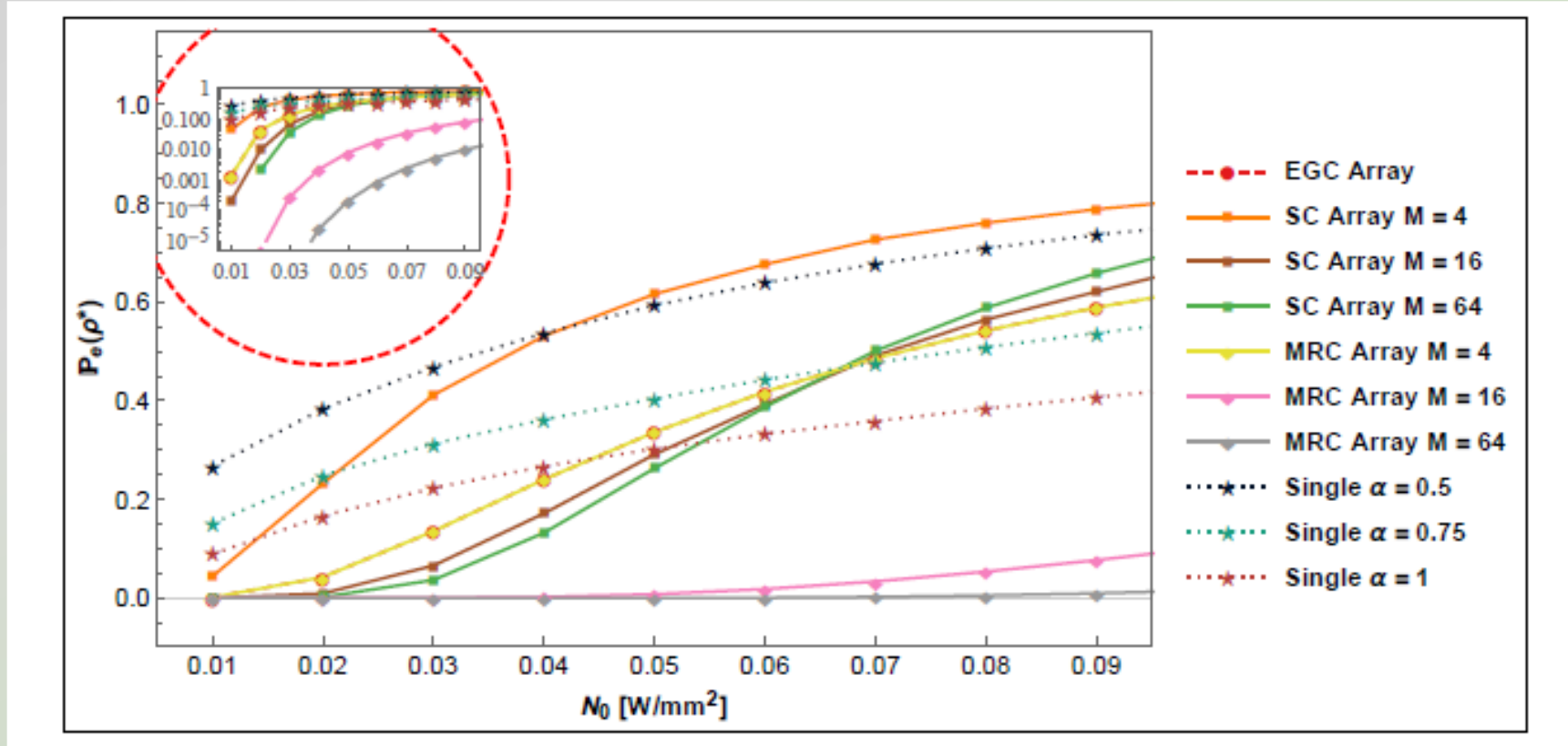

M. -C. Tsai, M. S. Bashir and M. -S. Alouini, "Probability of error performance comparison of a single detector versus an array of detectors", Under review.



UAV-Assisted Communication



Emergency



Massive Event



Global Connectivity



Military



Tethered UAVs

vs.

Untethered UAVs





Regular/Untethered UAV (uUAV)

- **Line-of-sight with ground users**
 - Probability increases with altitude
- **Mobility and relocation flexibility**
 - Track the time-varying traffic demand spatial distribution

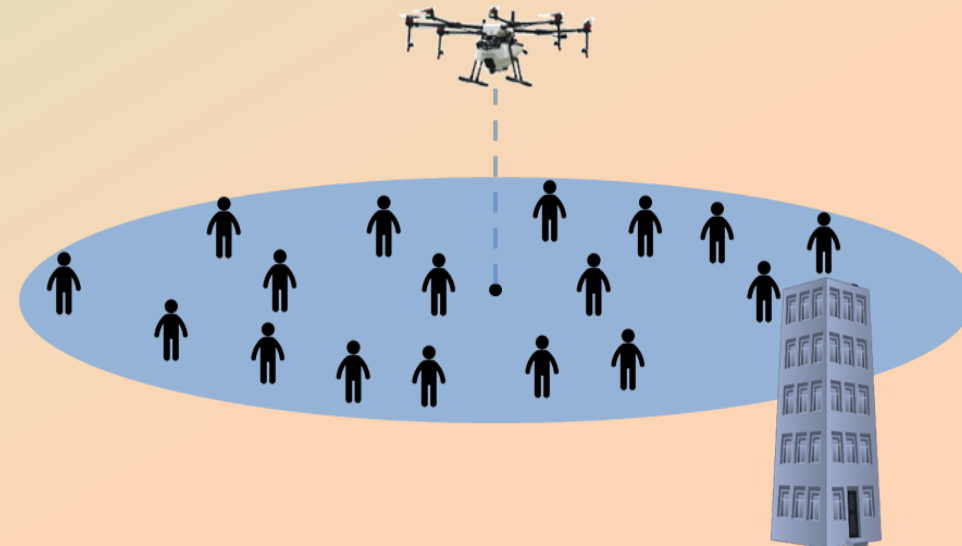
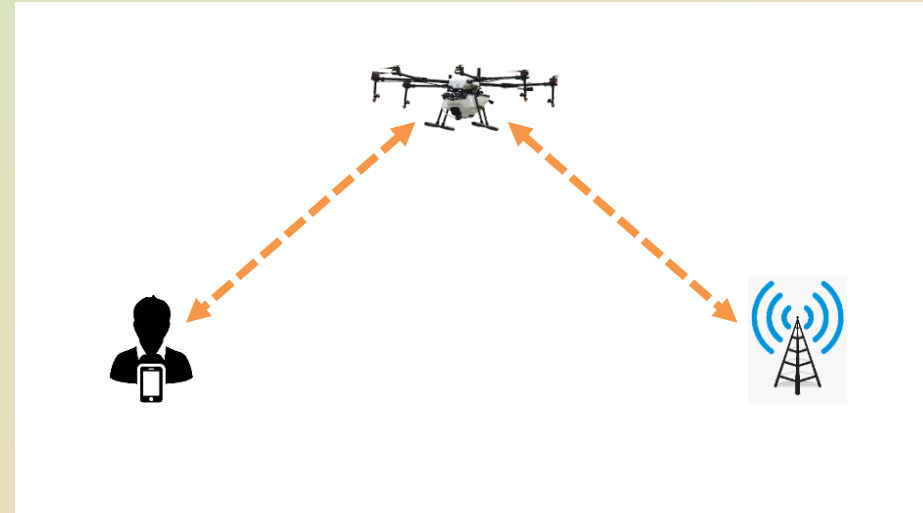



Limitations of uUAVs

- **Limited battery capacity**
 - UAV limited availability (average flight time in untethered UAVs is less than 1 hour)
 - Restrictions on the payload (number of antennas/RF chains)
- **Service quality restricted by backhaul link capacity**
- **“Drone-flyaway” risk/problem**

Tethered UAVs (tUAVs)

- **Flight time improvement & increased payload**
 - Powered by a ground station
- **Wired backhaul to the core network through high capacity link**
 - Avoid the inherent unreliability of UAV wireless backhaul.
- **Avoid “Drone-flyaway” risk & problem**

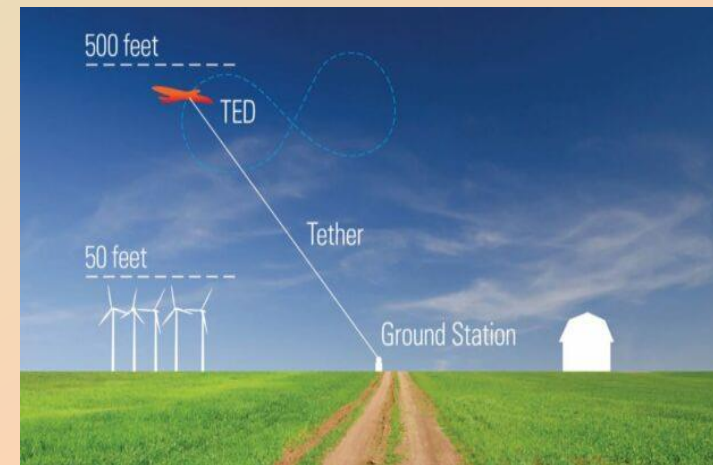
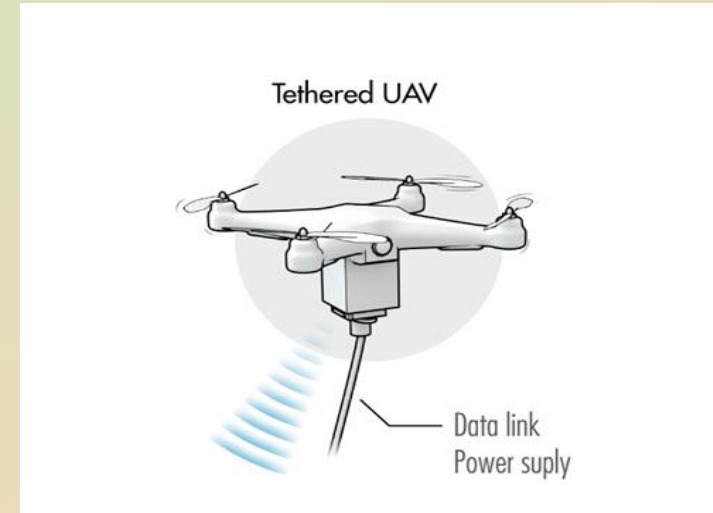

M. A. Kishk, A. Bader, & M.-S. Alouini, “Capacity & coverage enhancement using long-endurance tethered airborne base stations,” *IEEE Vehicular Tech. Magazine* 2020. Online: arxiv.org/abs/1906.11559

Urban Deployment

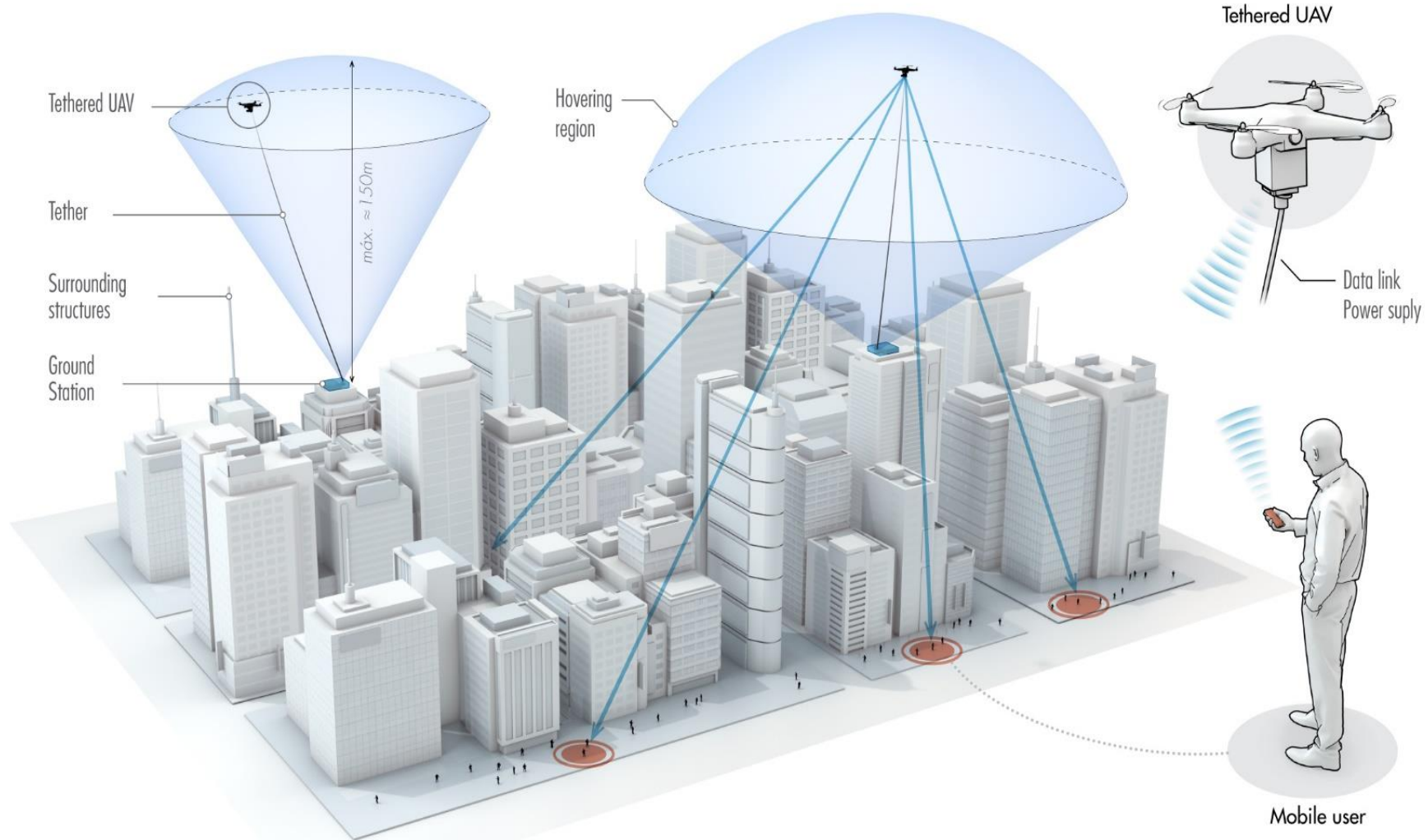

Tethered versus Untethered UAVs

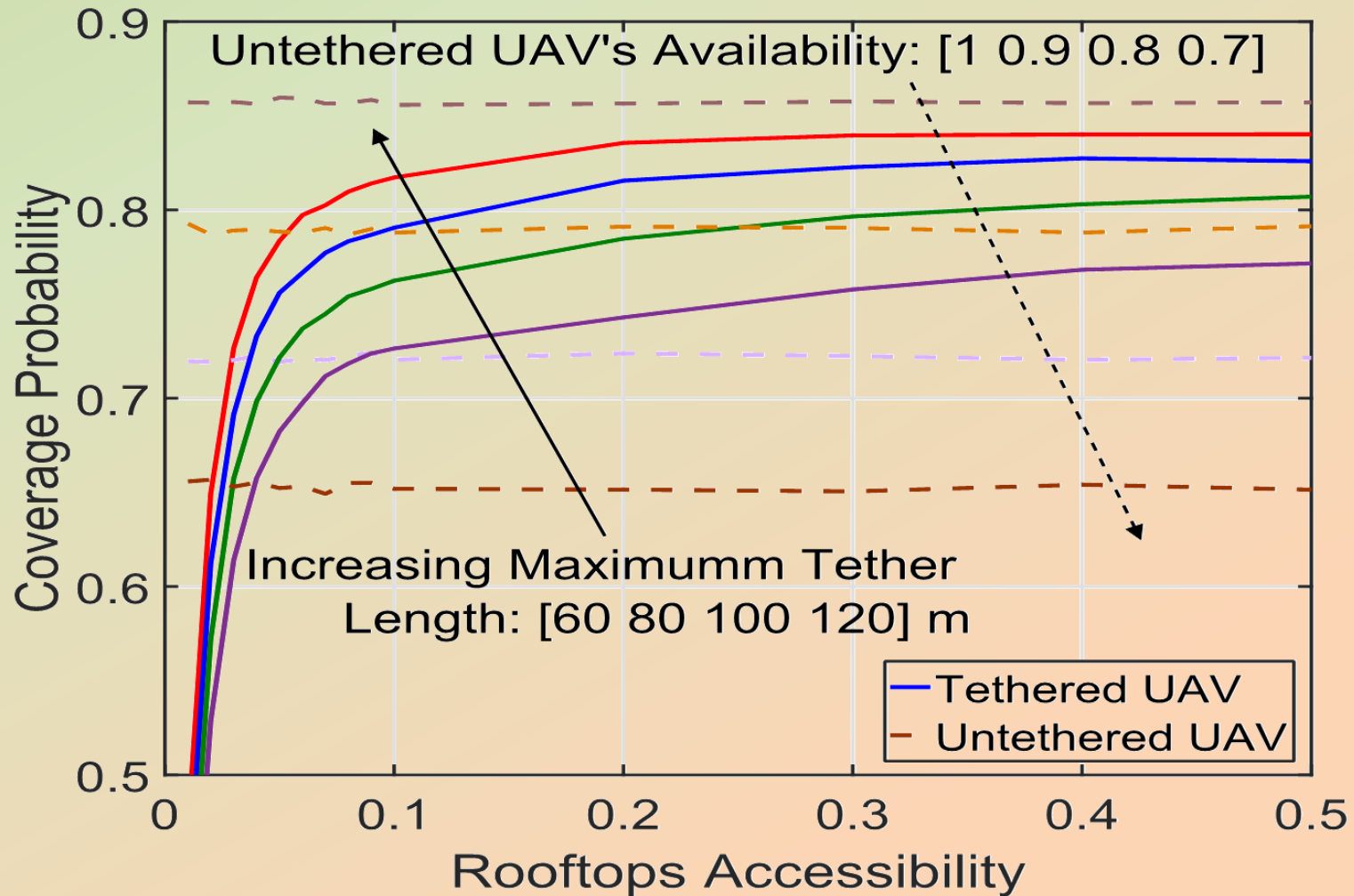



Tether Alternatives : Laser Beaming



Laser-powered UAVs

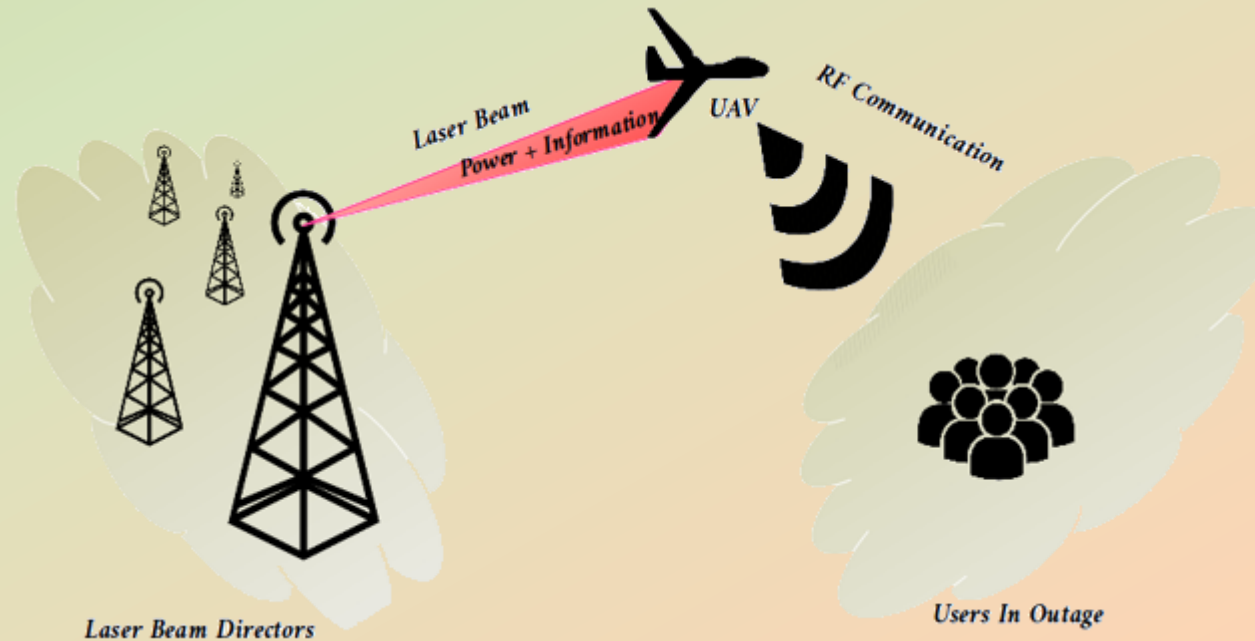

Simultaneous Lightwave Information and Power Transfer (SLIPT)

M. Lahmeri, M. A. Kishk and M.-S. Alouini, "Stochastic Geometry-based Analysis of Airborne Base Stations with Laser-powered UAVs," *IEEE Communications Letters*, 2019.



Performance Metrics & Parameters

- Performance Metrics:
 - Energy coverage probability.
 - SNR coverage probability.
 - Joint coverage probability.
- Parameters Affecting Performance
 - LBDs density.
 - Atmospheric turbulence

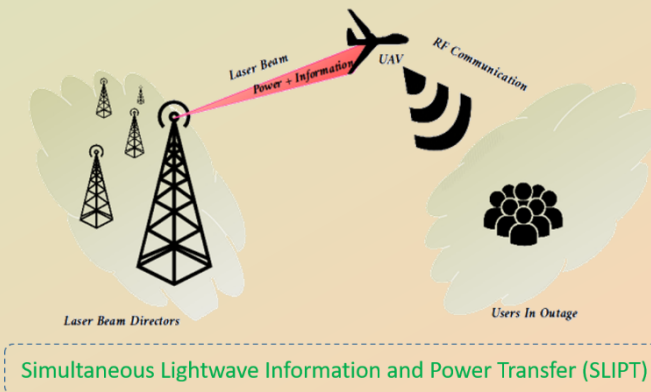

Energy Coverage Probability

$$P_{\text{energy}} = \mathbb{P}(p_{\text{harv}}(R) > p_{\text{prop}} + p_{\text{comm}})$$

Harvested power

Propulsion power

Communication-related
power

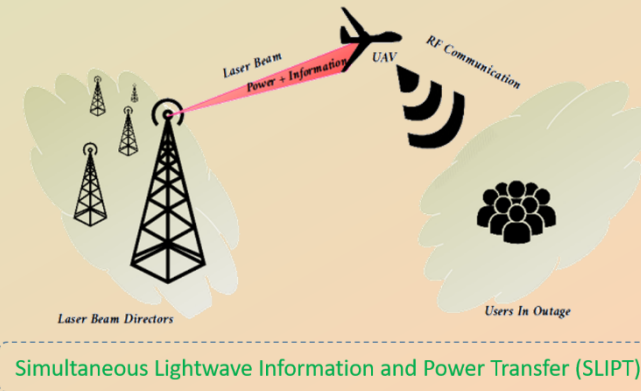

M. Lahmeri, M. A. Kishk and M.-S. Alouini, "Stochastic Geometry-based Analysis of Airborne Base Stations with Laser-powered UAVs," *IEEE Communications Letters*, 2019.

Main Results on Energy Coverage Probability

$$P_{\text{energy}} = \mathbb{P}(p_{\text{harv}}(R) > p_{\text{prop}} + p_{\text{comm}}).$$

Lemma 1: The energy coverage probability has the following upper bound

$$P_{\text{energy}} \leq 1 - e^{-\lambda_L \pi R^2}.$$

Lemma 2: The energy coverage probability is given by:

$$P_{\text{energy}} = \int_0^\infty (1 - F_{h_t}(a(r))) 2\pi \lambda_L r e^{-\lambda_L \pi r^2} dr,$$

where F_{h_t} is the cumulative distribution function of the turbulence h_t .

$$a(r) = \frac{p_{\text{prop}} + p_{\text{comm}}}{p_{\text{harv}}(r)}$$

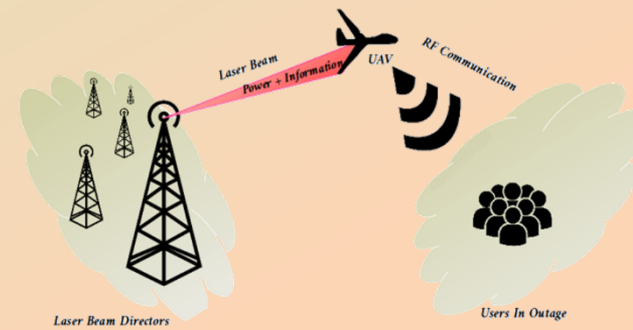

Simultaneous Lightwave Information and Power Transfer (SLIPT)

M. Lahmeri, M. A. Kishk and M.-S. Alouini, "Stochastic Geometry-based Analysis of Airborne Base Stations with Laser-powered UAVs," *IEEE Communications Letters*, 2019.

Energy Coverage Probability versus Density of LBDs

$$P_{\text{energy}} = \mathbb{P}(p_{\text{harv}} > p_{\text{prop}} + p_{\text{comm}})$$

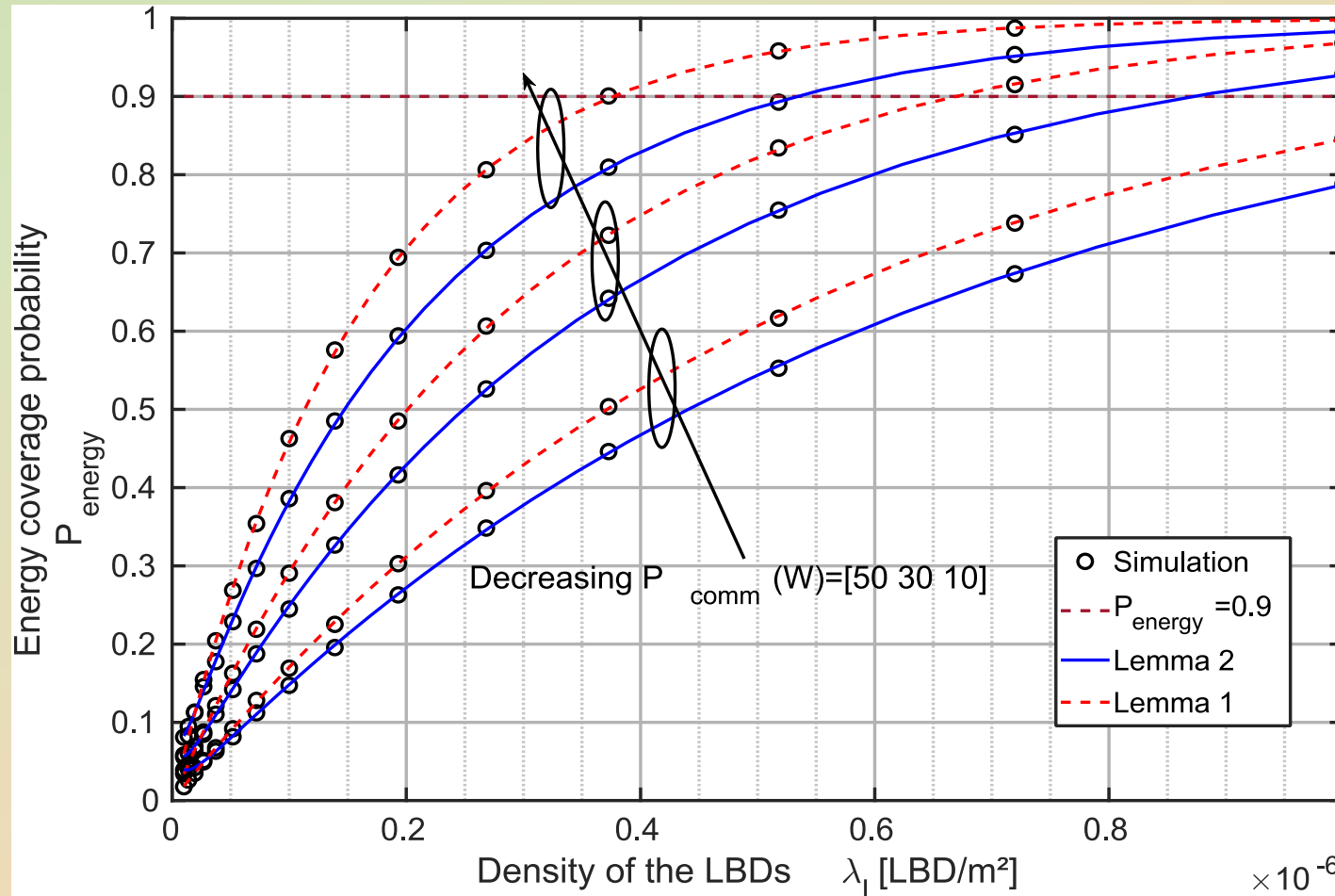

Main Results on SNR Coverage Probability

SNR Coverage Probability

$$P_{\text{SNR}} = \mathbb{P}(\text{SNR}_{\text{UAV}} > \beta)$$
$$= \int_0^\infty \left(1 - F_{h_t}(b(r))\right) 2\pi\lambda_L r e^{-\lambda_L \pi r^2} dr,$$

where $b(r) = \frac{2q\Delta f\beta}{\delta_s \eta p_{\text{harv}}(r)}$.

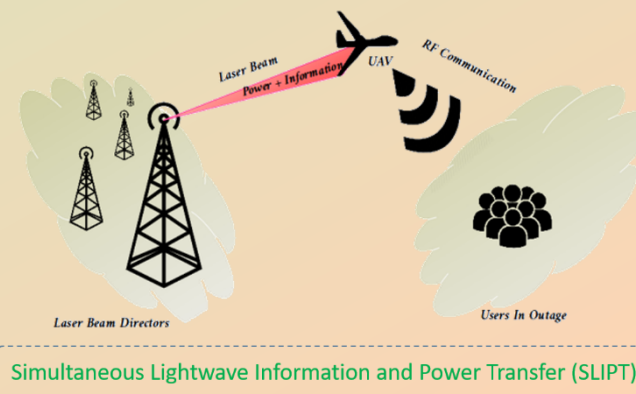

M. Lahmeri, M. A. Kishk and M.-S. Alouini, "Stochastic Geometry-based Analysis of Airborne Base Stations with Laser-powered UAVs," *IEEE Communications Letters*, 2019.

SNR Coverage Probability versus Density of LBDs

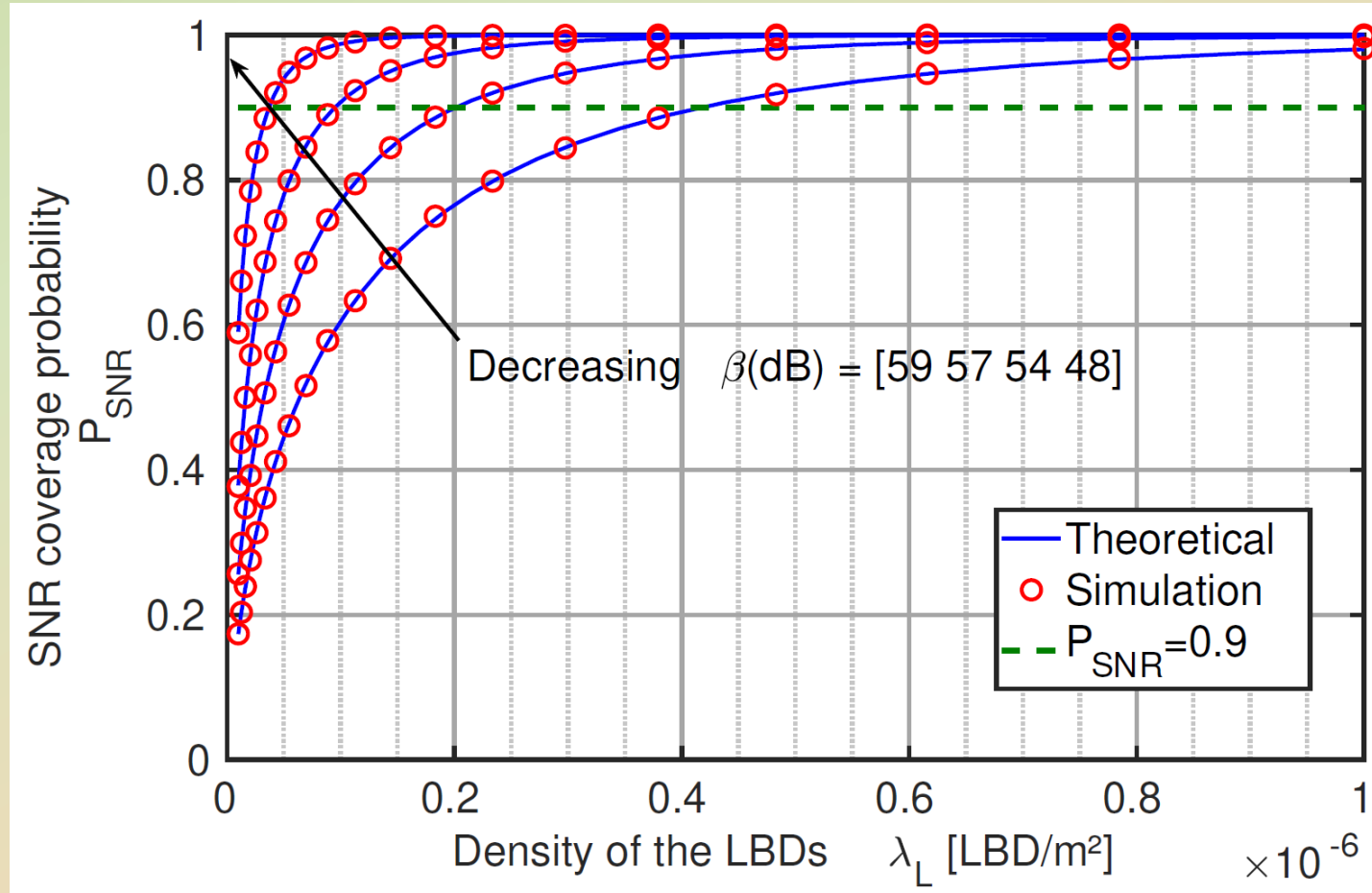

M. Lahmeri, M. A. Kishk and M.-S. Alouini, "Stochastic Geometry-based Analysis of Airborne Base Stations with Laser-powered UAVs," *IEEE Communications Letters*, 2019.

Joint Coverage Probability versus SNR Threshold

$$P_{\text{joint}} = \mathbb{P}(p_{\text{harv}}(R) > p_{\text{prop}} + p_{\text{comm}}, \text{SNR}_{\text{UAV}} > \beta)$$

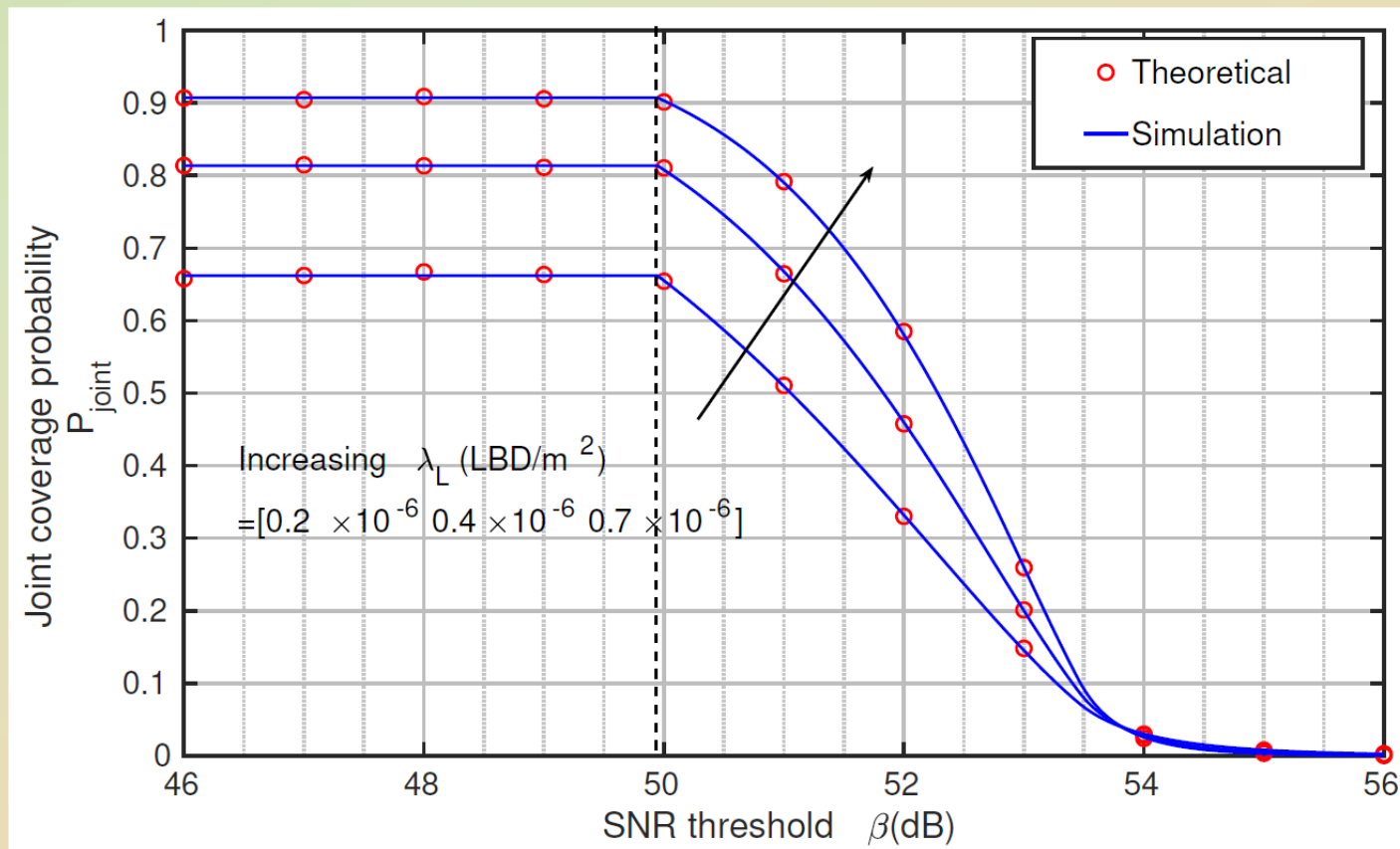

M. Lahmeri, M. A. Kishk and M.-S. Alouini, "Stochastic Geometry-based Analysis of Airborne Base Stations with Laser-powered UAVs," *IEEE Communications Letters*, 2019.

Joint Coverage Probability versus Power Splitting Factor

$$P_{\text{joint}} = \mathbb{P}(p_{\text{harv}}(R) > p_{\text{prop}} + p_{\text{comm}}, \text{SNR}_{\text{UAV}} > \beta)$$

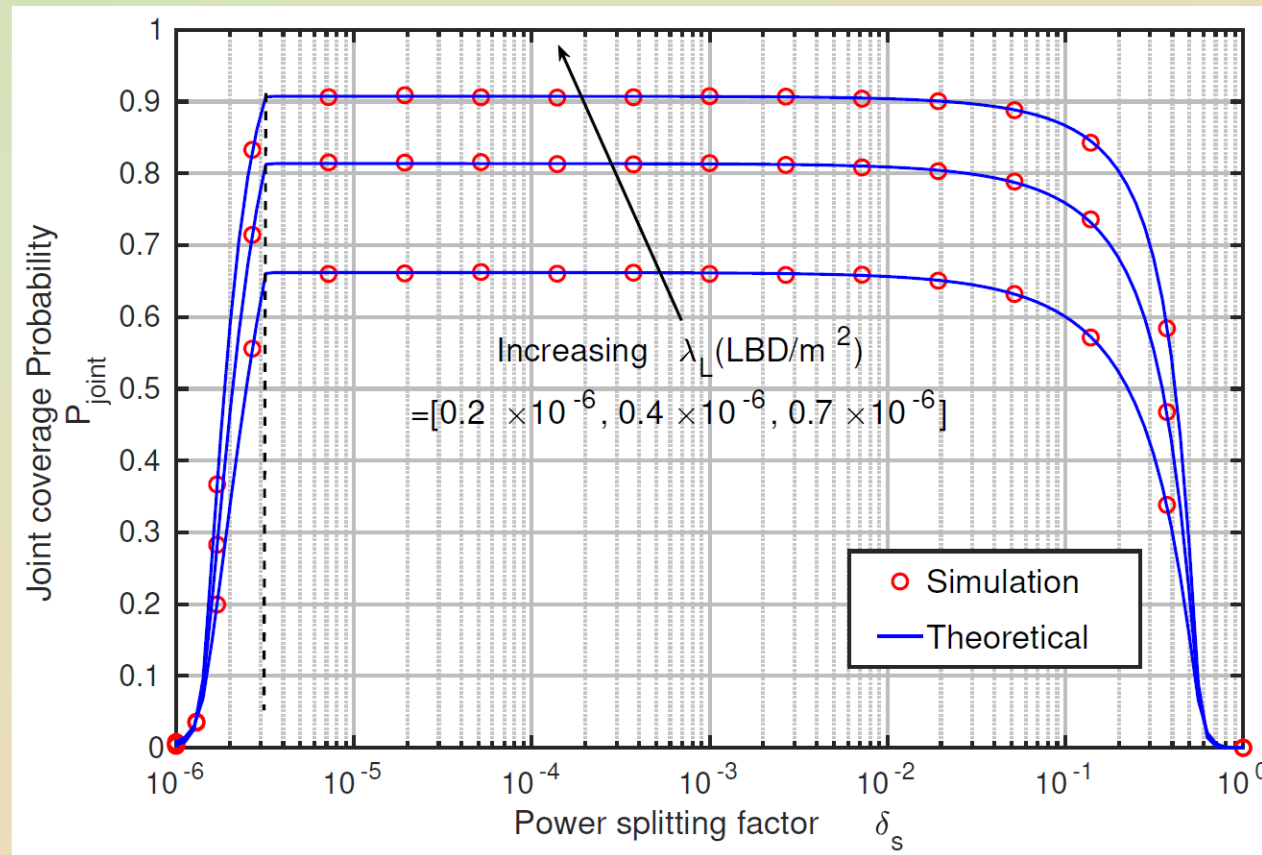

M. Lahmeri, M. A. Kishk and M.-S. Alouini, "Stochastic Geometry-based Analysis of Airborne Base Stations with Laser-powered UAVs," *IEEE Communications Letters*, 2019.

Nikola Tesla

(10 July 1856 – 7 January 1943)

“When wireless is perfectly applied, the whole earth will be converted into a huge brain, which in fact it is, all things being particles of a real and rhythmic whole. We shall be able to communicate with one another instantly, irrespective of distance.”

Nikola Tesla (1925)



جامعة الملك عبدالله
للعلوم والتقنية
King Abdullah University of
Science and Technology



Thank You

ctl.kaust.edu.sa

slim.alouini@kaust.edu.sa

