

Tutorial



NetWare 2020 Congress
November 21, 2020 to November 21, 2020
Valencia, Spain



Visible Light Communications

A new way to communicate: potential and challenges

Manuela Vieira

Manuel Augusto Vieira

Paula Louro

Pedro Vieira

Alessandro Fantoni



Summary



Visible Light Communications

A new way to communicate: potential and challenges...

1. Manuela Vieira
2. Research center
3. Light sources
4. Optical Communications
 - I. Visible Light communication
 - II. Indoor Applications
 - III. Outdoor Applications
5. Silicon Photonics for Biosensing Applications
6. Radio planning
7. 5G



Manuela Vieira was born in Lisbon, Portugal. In 1986, she received the Master of Science in Solid State Physics-Microelectronic and in 1993 the PhD in Semiconductor Materials, both from the New University of Lisbon. She receives the habilitation title in Electronics, in 2003 from New University of Lisbon, Portugal.

- She is a Full Professor, since 2011, in Electronics inside the Department of Electronics Telecommunication and Computers (ISEL-Portugal) and Associated Professor in the New University of Lisbon, School of Sciences and Technology (UNL-FCT, Portugal).
- She is also the Leader of the Research Groups in Applied Research in Microelectronic Optoelectronic and Sensors (GIAMOS / ISEL) and in Microelectronic, Material and Processes (M2P/ CTS-UNINOVA). She has several scientific papers and has participated in many international and national projects, both as a researcher and as a project coordinator. She has 30 years of experience in the field of thin films and devices and on Visible Light Communication.

Other scientific activities:

- Referee for international publications such as: Thin Solid Films, Material Research Society, Sensor Magazine, Sensor and Actuators, Material Science Fórum, Solid State Electronics, Vacuum, Applied Surface Science, Sensors and Transducers, Revista Ibersensors, Physica Status Solidi, Sensors, Journal of Nanoscience Nanotechnology, Journal of Sensors, Journal of Signal and Imaging Systems Engineering (IJSISE), etc.
- Evaluator of proposals submitted to several international funding organizations
- Supervision and co-supervision of Master and PhD students
- Examiner for Master and Doctoral degrees.
- Authored and co-authored over than 400 publications in refereed journals and conferences proceedings. Presented more than 500 communications at conferences and seminars most of which with publication in journals and proceedings. She is an IARIA Fellow since 2018.

Manuela Vieira
mv@isel.ipl.pt

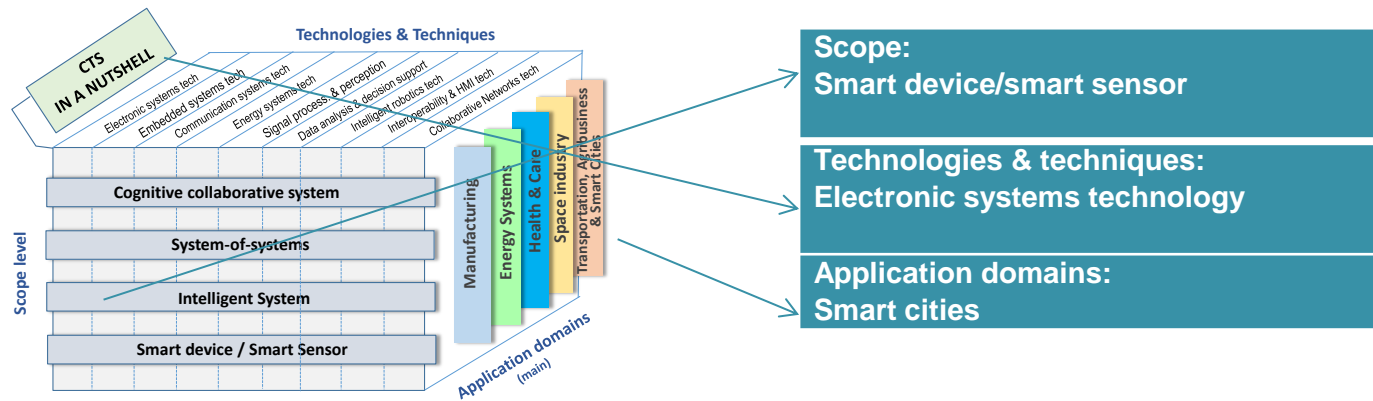



ISEL-ADEETC

Rua Conselheiro Emídio
Navarro, 1
1959-007 Lisboa
Portugal

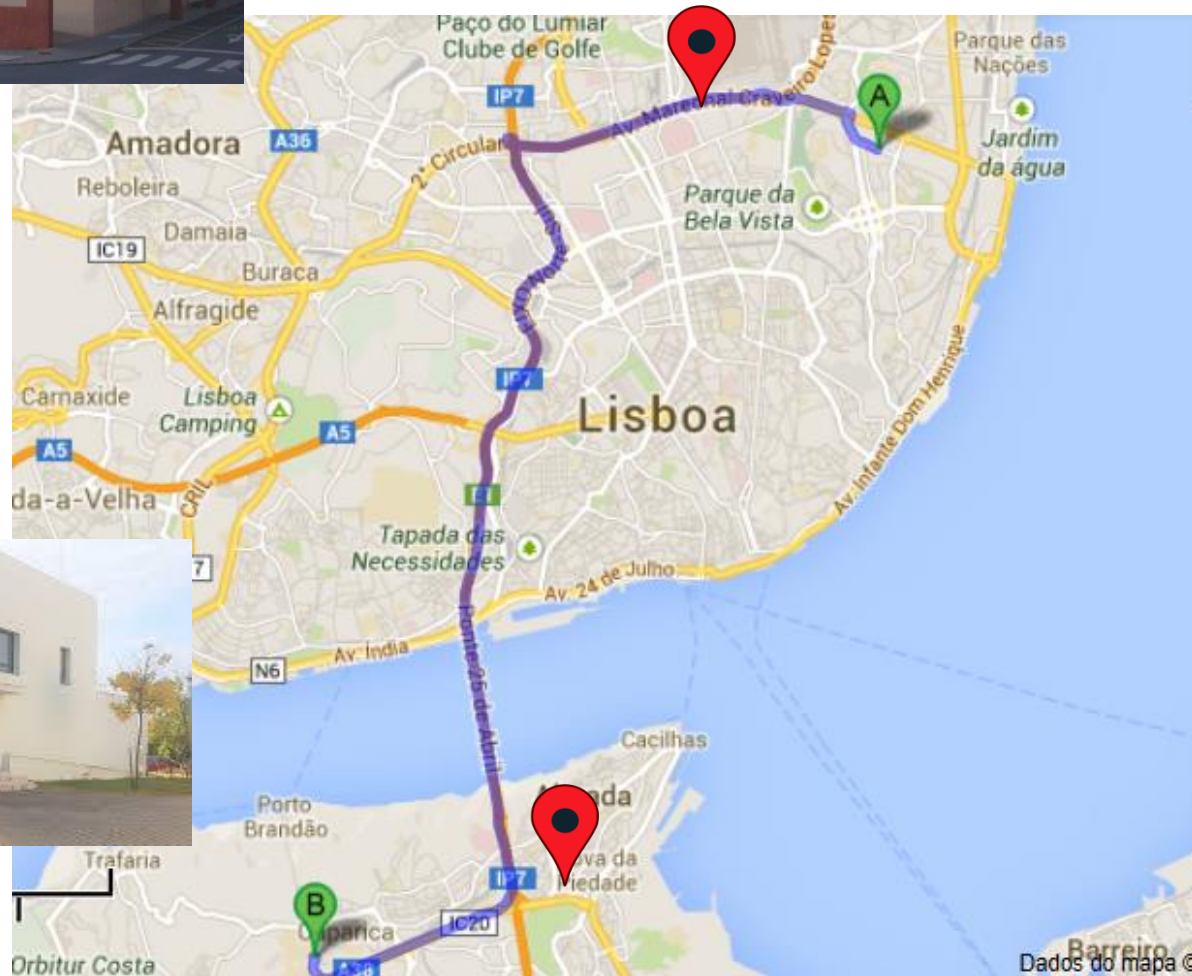

CTS-UNINOVA

FCT Campus
2829-516 Caparica,
Portugal

M2P Research group



CTS

A group of experienced and young researchers covering the areas of materials and devices processing; materials and devices characterization and optimization, well supported by the physics modelling of the devices and the corresponding software for information extraction

- Development, optimization and application of semiconductor based devices: image and color sensors, optoelectronic devices, solar cells, optical amplifiers, biosensors, VLC devices, nanostructures and UV and IV detectors.

- Design and modeling of optical devices.

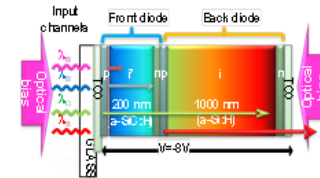

- Electrical and numerical simulation of optical devices.

- Integration of different technologies, namely: optical sensors, wavelength-division multiplexing, waveguides, Visible Light Communication, X-ray detectors and full digital medical imaging.

- Optical Communications.

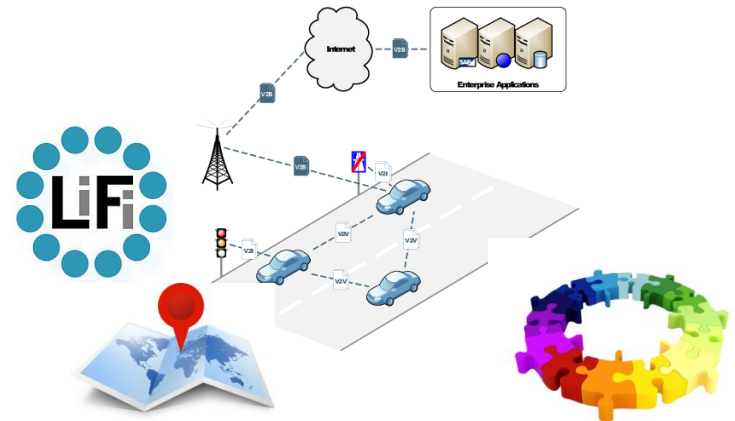
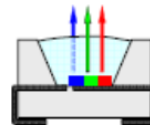
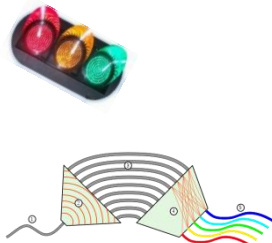
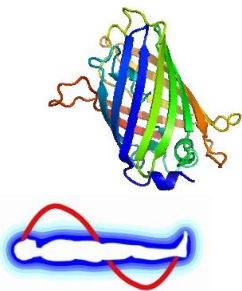

- Applications of semiconductor devices

- Wavelength Division Multiplexing (WDM)

- Optical biosensors

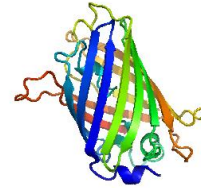

- X-ray flat panel



- OLEDs



- Nanodevices

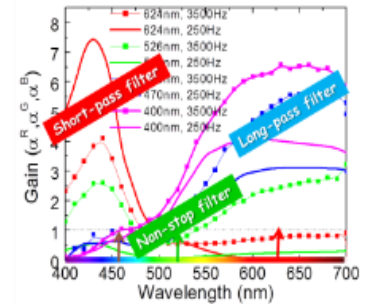
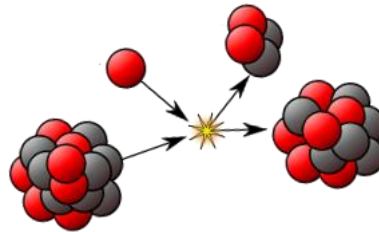

- Visible Light Communications

- Indoor positioning systems

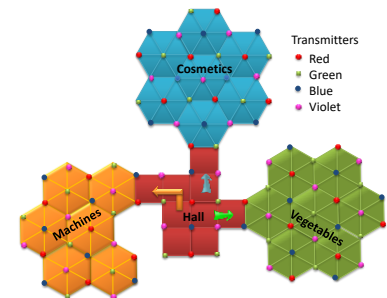

- Vehicular Communications

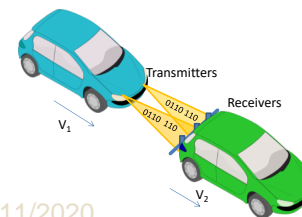



- **Deposition facilities:**

- Laboratories for support of Semiconductor Thin Film Development using the PECVD (Plasma Enhanced Chemical Decomposition) techniques.
- Laboratories for support of Electronic, Optoelectronic and Microelectronic Device Processing.

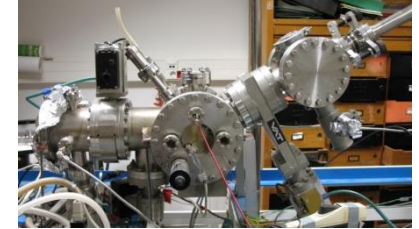

- **Characterization facilities:**

- UV-VIS-NIR and IR Spectrophotometers (Shimadzu),
- dark/photo conductivity as a function of temperature;
- spectral response;
- Flying Spot Technique-FST;
- Photothermal Deflection Spectroscopy-PDS;
- Space Charge Limited Current-SCLC;
- C(T)/C(V) measurements,
- Coatings uniformity test-bench,
- Characterization systems for devices (IV characteristics; annealing test chambers; degradation tests; interface characterization; Electroluminescence) and Solar simulator for small areas.
- Spectrometers (UV, VIR, NIR, IR) and
- Optical Characterization Systems (I-V, C-V),
- Electric Characterization Systems,
- Material Testing Bench.

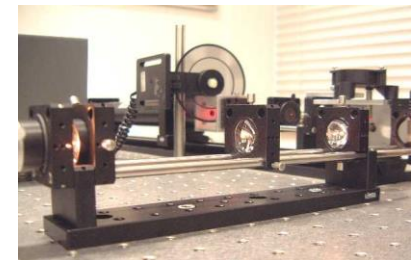

SPECTRAL DISTRIBUTION



FORWARD RADIATED OPTICAL POWER



RADIAL INTENSITY DISTRIBUTION



TOTAL RADIATED OPTICAL POWER

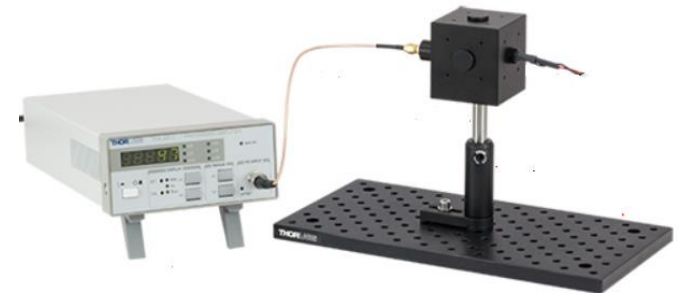



Abbreviated Journal Title

APPL PHYS LETT

IEEE T ELECTRON DEV

SENSORS and
TRANSDUCERS

J APPL PHYS

J. NANOSCI. NANOTECH

J. OPTICAL ENG.

J. LUMINESCENCE

PHISICA STATUS SOLIDI

PLASMONIC

THIN SOLID FILMS



DISSEMINATION

- Department of Electrical and Computer Eng., Waterloo, Canada.
- Giga to Nano Electronics Group, Univ. Waterloo, Canada.
- University of Cagliari, Italy.
- IPE, Stuttgart University, Germany
- Institute of Semiconductor Physics, Ukrainian Academy of Science, Kiev, Ukraine.
- Institute of Physics, Polish Academy of Sciences, Warszawa, Poland.
- Institute of Molecular Physics University, Polish Academy of Sciences, Poland.
- Wurzburg University, Germany.
- Polish Academy of Sciences, Poland
- University of Salerno, Italy
- La Sapienza Universitat, Rome,

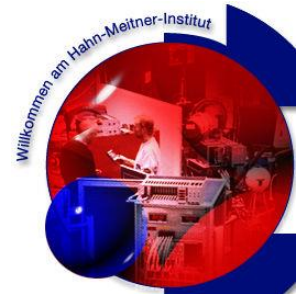

- ✓ Production of semiconductor devices,
- ✓ Characterization of materials and devices,
- ✓ Joint publications.





GEO-LOC

“Indoor and Outdoor Geo-Localization and Navigation by Visible Light Communication”

IDI&CA program, 5th Edition, 2020-2021

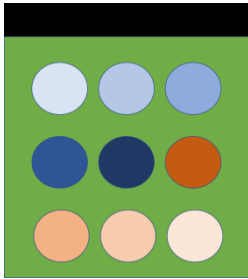

AGE-SPReS

“Arrayed Graphene Enhanced Surface Plasmon Resonance for Sensing Applications”

IDI&CA program, 5th Edition, 2020-2021

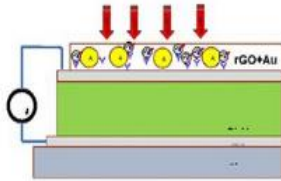

PhotoAKI

“Photonic Biosensor for point of care and Early Diagnostics of Acute Kidney Injury”

LISBOA-01-0145-FEDER-031311, 2018-2021

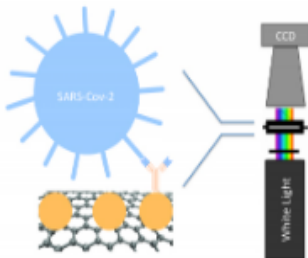

QuiCoviDe

“Quick COVID-19 Detection”

FCT, Research 4 COVID 19 program, 2020-2021

NATURAL LIGHT SOURCES



Sun light



Moon light

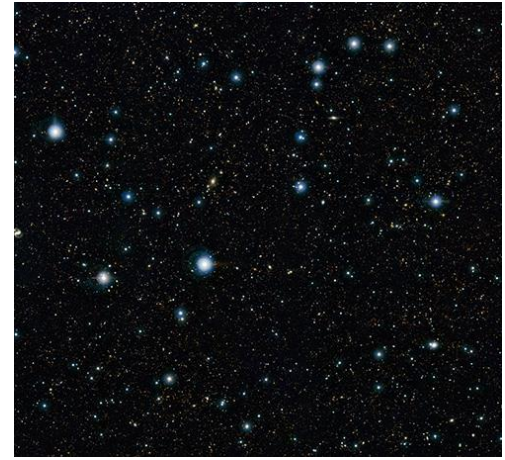

Stars light

ARTIFICIAL LIGHT SOURCES



Candles, torche, oil lamp



Electrical lamps: incandescent, fluorescent, LED/LASER



LIGHT SOURCES

H

TIMELINE OF MAJOR DISCOVERIES IN MODERN LIGHTING TECHNOLOGIES

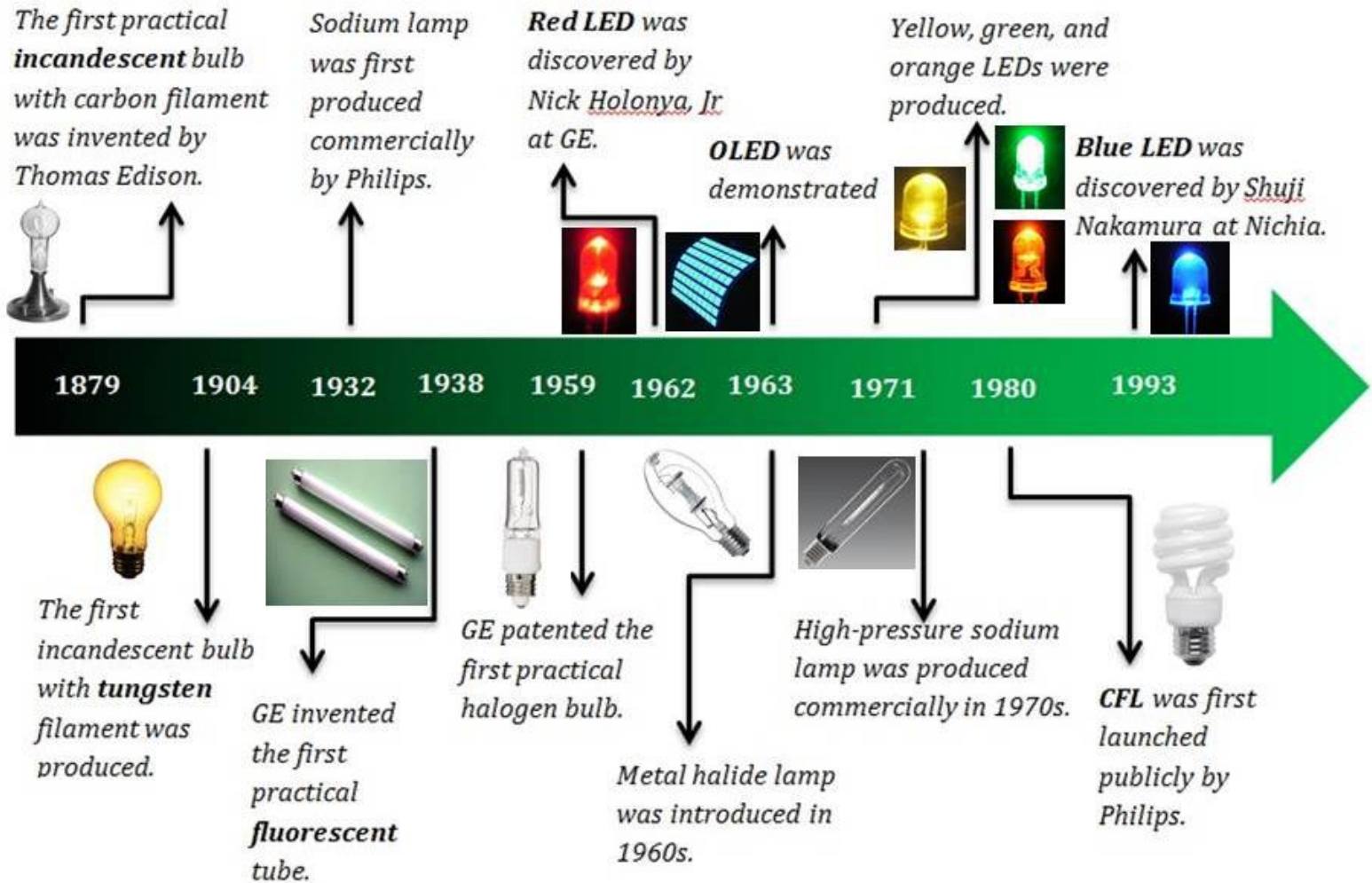

IMPORTANCE OF LIGHT ON EARTH AND ON LIFE

Life on Earth depends on light.

Without it the human survival would be impossible:

- Earth temperature regulation
- Body temperature (fishes, amphibians, reptiles)
- Vision ability
- Calcium absorption in bones
- Production of hormones (e.g., melatonin to synchronize the circadian rhythm)
- Production of oxygen through the photosynthesis process performed by green plants

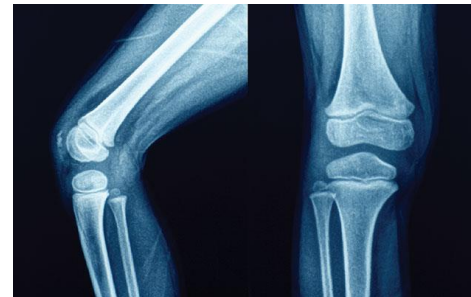
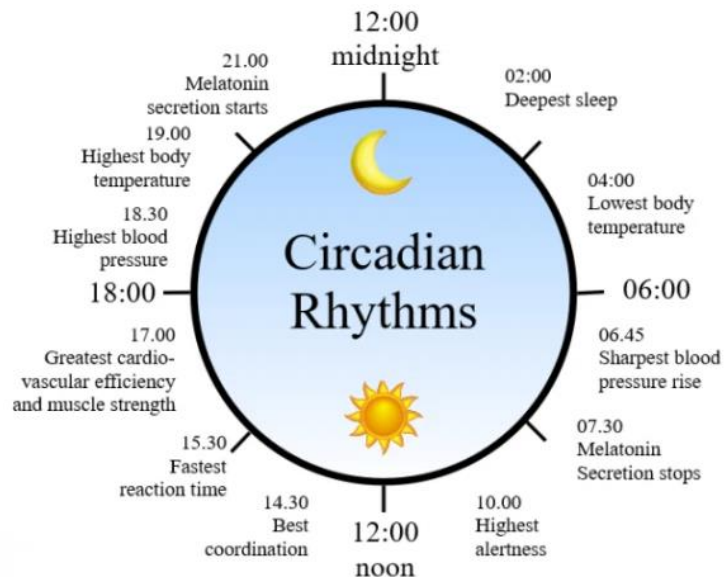

CAR & VEHICLES

- Infrared security systems
- Optical fiber dashboard displays
- LED traffics signals
- Laser traffic radars
- Solar-powered emergency brakes

MEDICINE

- Laser surgery
- Laparoscopy
- Medical diagnosis tool
- Imaging Medical devices
- Clip-on pulse oximeters,
- IR skin thermometers
- Microscopes
- Light based therapies

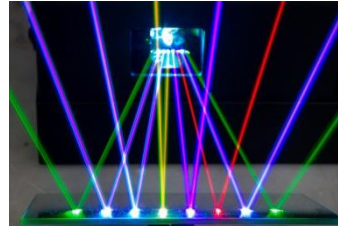

OTHERS

- Laser light shows
- Digital cameras
- Night vision goggles
- Missile guidance
- Laser weapons
- Surveillance cameras

HOME

- Energy saving lights
- Infrared remote controls
- TV flat panel
- Compact disc players
- Optical fibers for cable TV

OFFICE

- Optical scanners
- Laser printers
- Photocopiers
- Slide projectors
- Laser pointers
- Optical data storage

STORE

Supermarket bar code canners
Credit card hologram

MANUFACTURING

- Laser welding and cutting
- Optical stereo-lithography
- Machine vision
- Image recognition for quality control
- Nondestructive testing
- Precision measurement
- Optical inspection of labelling and packaging
- Laser fabric cutting machines

LIGHT AND UNITED NATIONS SUSTAINABLE DEVELOPMENT GOALS



LIGHT-based technologies can make a fundamental contribution to help accomplish these goals.

Optical Communications

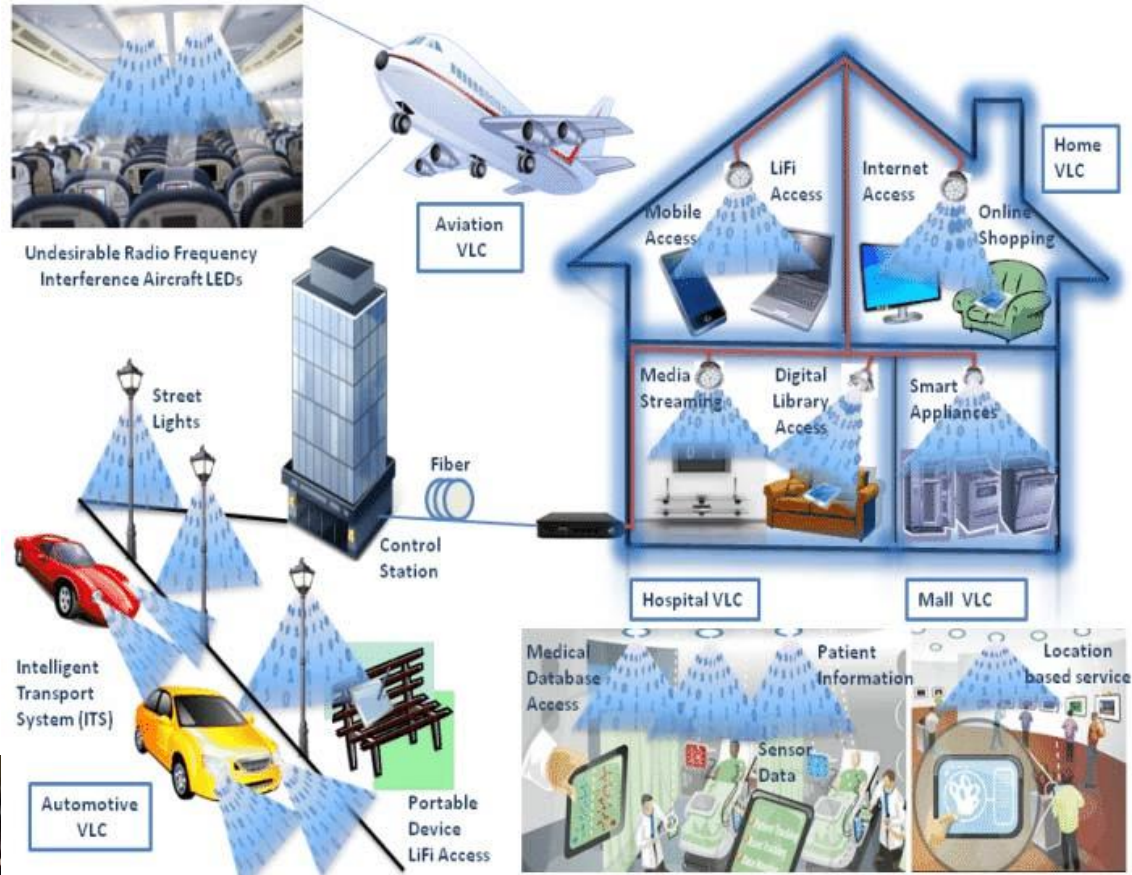

Manuela Vieira



Manuel A. Vieira

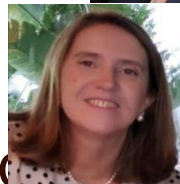

Paula Lourdes



Pedro Vieira

NOBEL in Physics 2009

TWO
REVOLUTIONARY
OPTICAL
TECHNOLOGIES

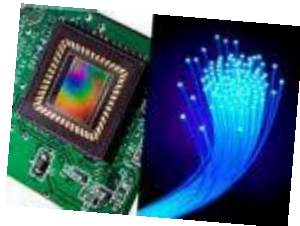

Charles K. Kao



Willard S. Boyle



George E. Smith

"The Nobel Prize in Physics 2009 honors three scientists, who have played important roles in shaping the modern information technology, with one half to **Charles K. Kao** and with **Willard S. Boyle** and **George E. Smith** sharing the other half."

GLOBAL INTERNET GROWTH AND TRENDS



By 2021

Wi-Fi will begin to become limited

More Internet Users



3.3 Billion

4.6 Billion

More Devices & Connections



17.1 Billion

27.1 Billion

Faster Broadband Speeds



27.5 Mbps

53.0 Mbps

More Video Viewing



73% of Traffic

82% of Traffic

Data traffic

2016
↓
2021

CAGR - Compound annual growth rate

Source: Cisco VNI Global IP Traffic Forecast, 2016-2021

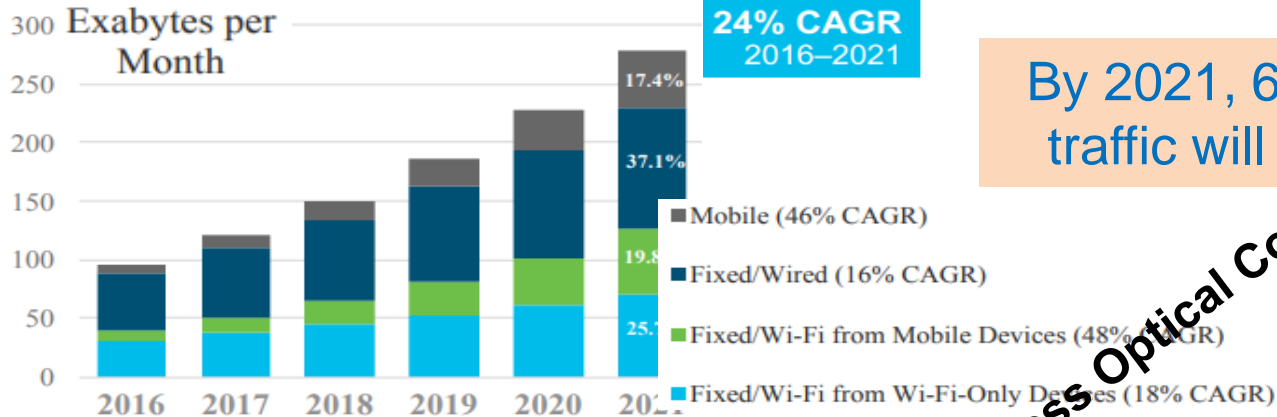

By 2021, 63% of total IP traffic will be wireless*

Wireless Optical Communications

* Wireless traffic includes Wi-Fi and mobile

ELECTROMAGNETIC SPECTRUM

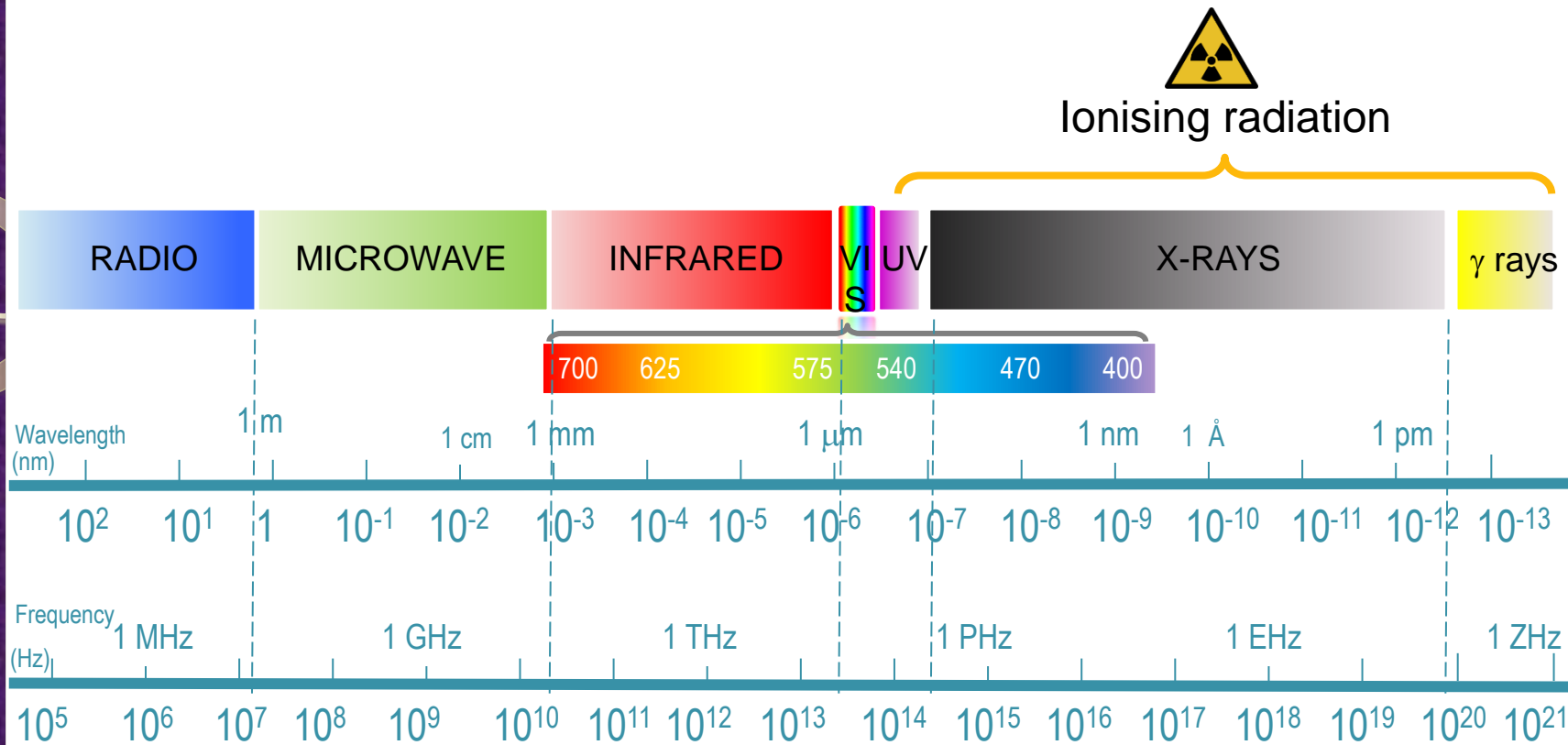

$$\text{wavelength}(m) = \frac{3 \times 10^8}{\text{frequency (Hz)}}$$

LIGHT TECHNOLOGIES

RADIO

AM radio station



FM radio station



Television station



Satellite communications



MICROWAVE

Microwave oven



GSM network



Satellite TV



Radio astronomy



Radar



GPS navigation

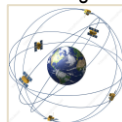

INFRARED

Far Mid Near

Night Vision



Optical fiber communication



Free space optics

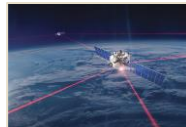

Remote controllers



Heater



Thermal imaging



Weather forecast

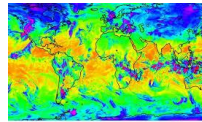

Eye vision



Lighting



VLC



Solar cell



Camera



ULTRAVIOLET

A B C

Dermatology



Disinfection



Dental curing



Nail curing



Tanning



Fluorescence



X-RAY

SOFT HARD

Radiation therapy



Medical x-ray/mammography



Computed tomography

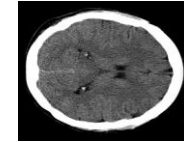

Industrial x-ray



Airport security



Crystallography

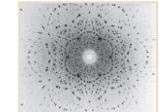

Astronomy



GAMMA

Nuclear medicine



PET imaging

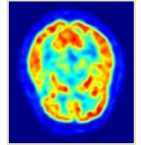

Scintigraphy

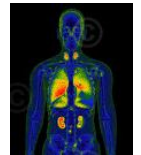

Radioactive seed implantation



Cosmic ray observation

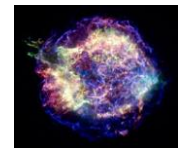

COMMUNICATION SPECTRUM

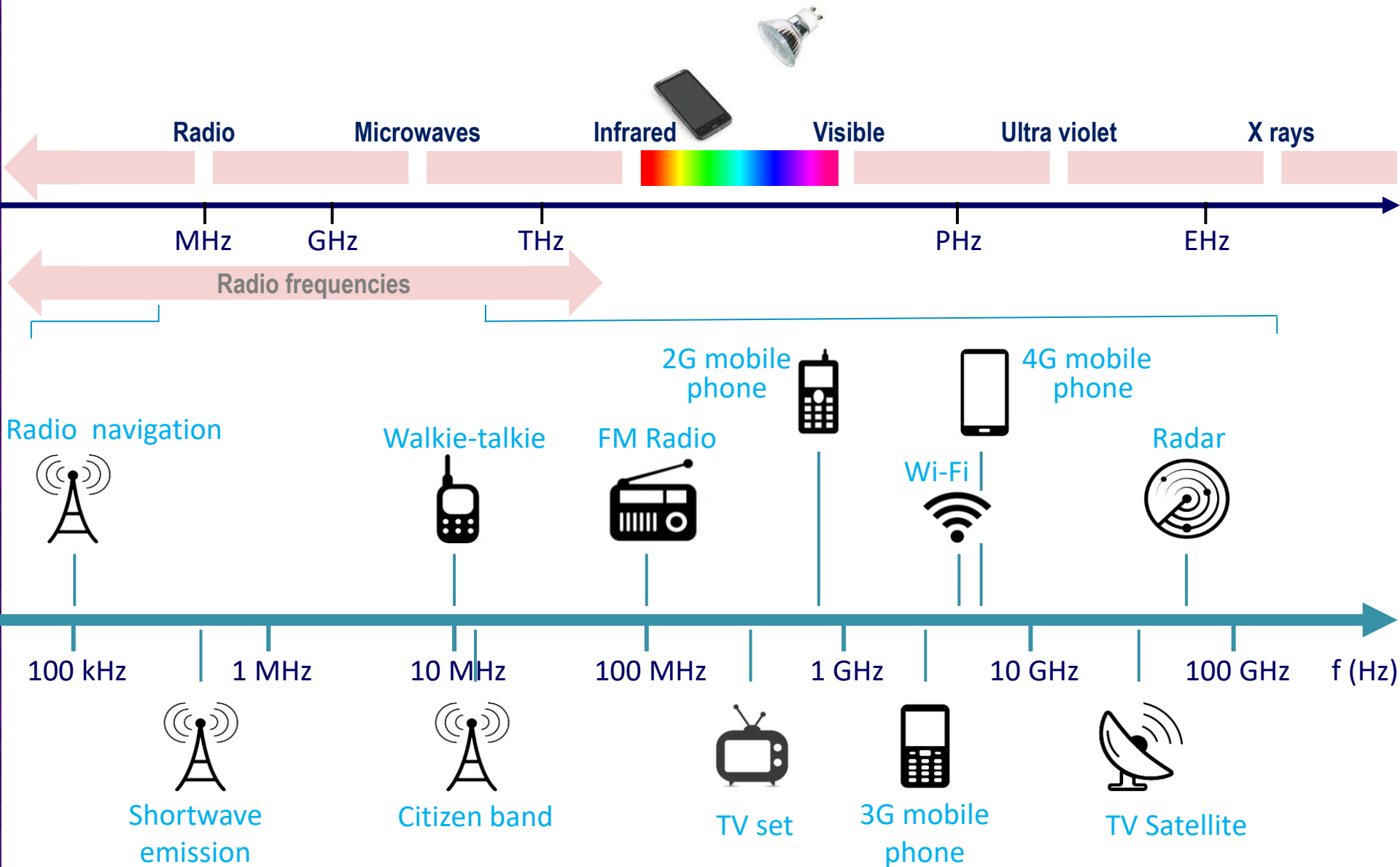

OWC Optical Wireless Communications



FSO Free Space Optical Communications



VLC Visible Light communication

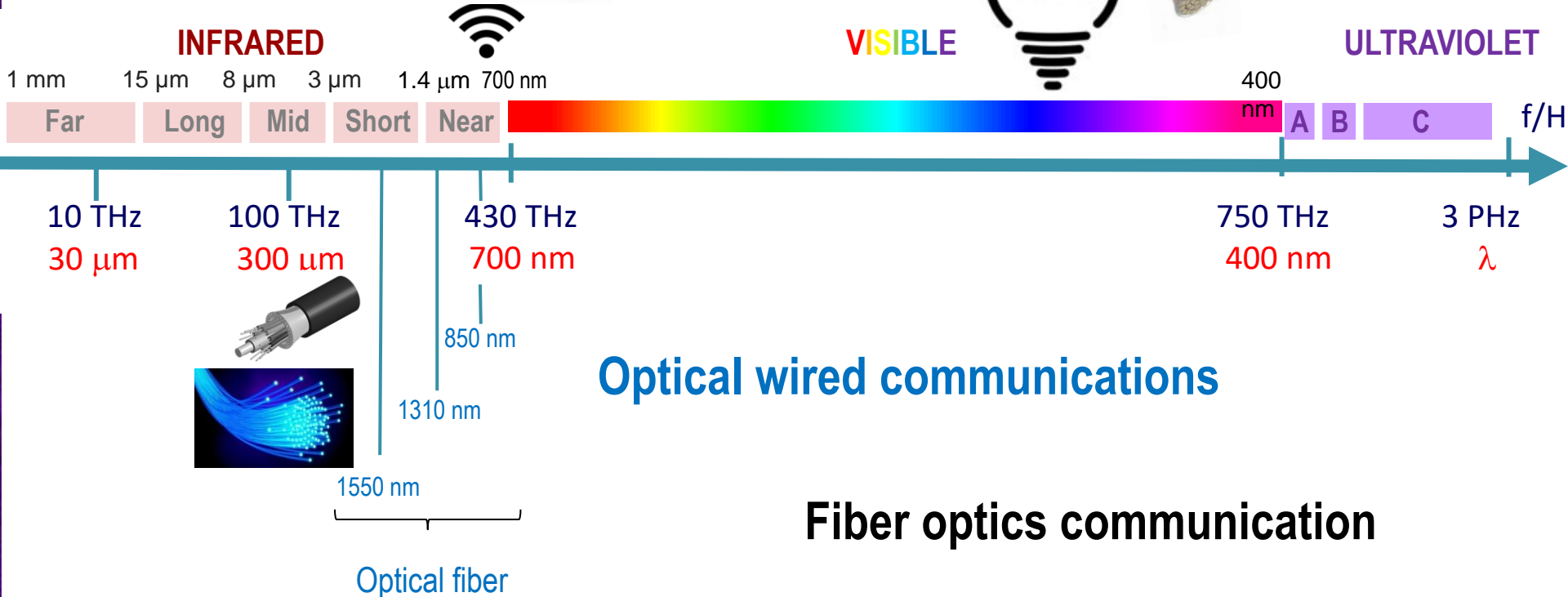

VLC – Visible Light Communication

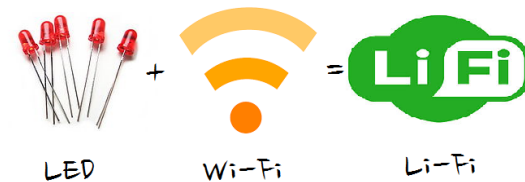
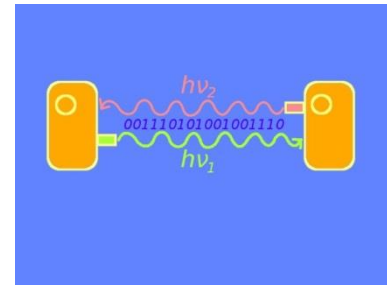
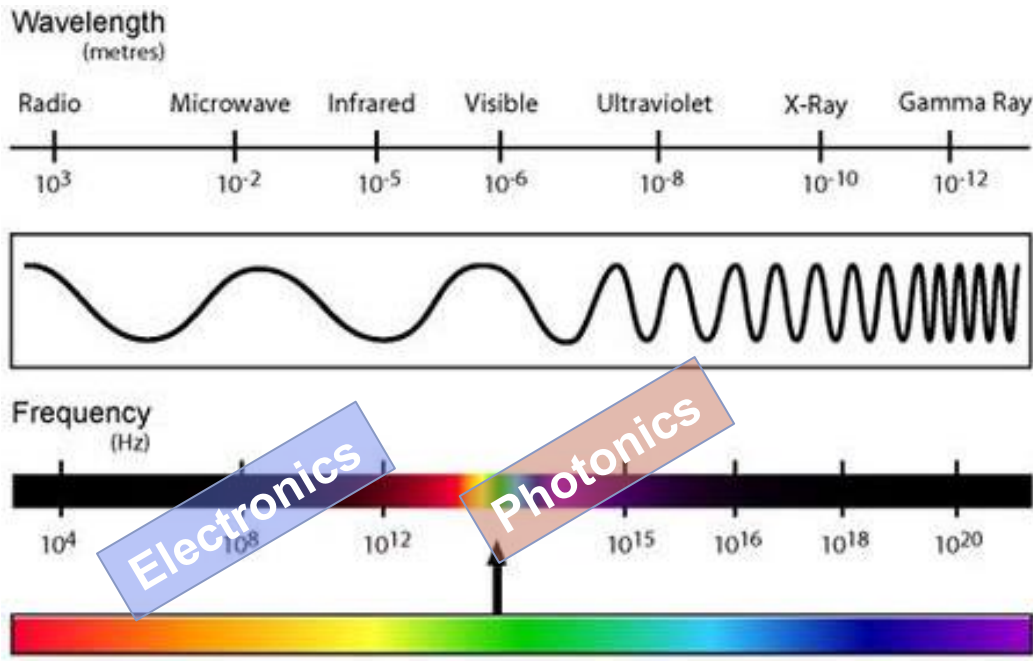

- increased bandwidth
- free and non-regulated spectrum
- line of sight technology (1 – 100 m)
- negligible power
- inexpensive (use of already existing lighting infra-structures)

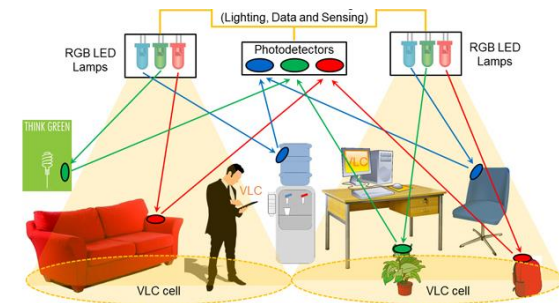

Visible Light Communication

Li-Fi is a Visible Light Communications (VLC) system



Li-Fi and Wi-Fi are quite similar as both transmit data through the electromagnetic spectrum

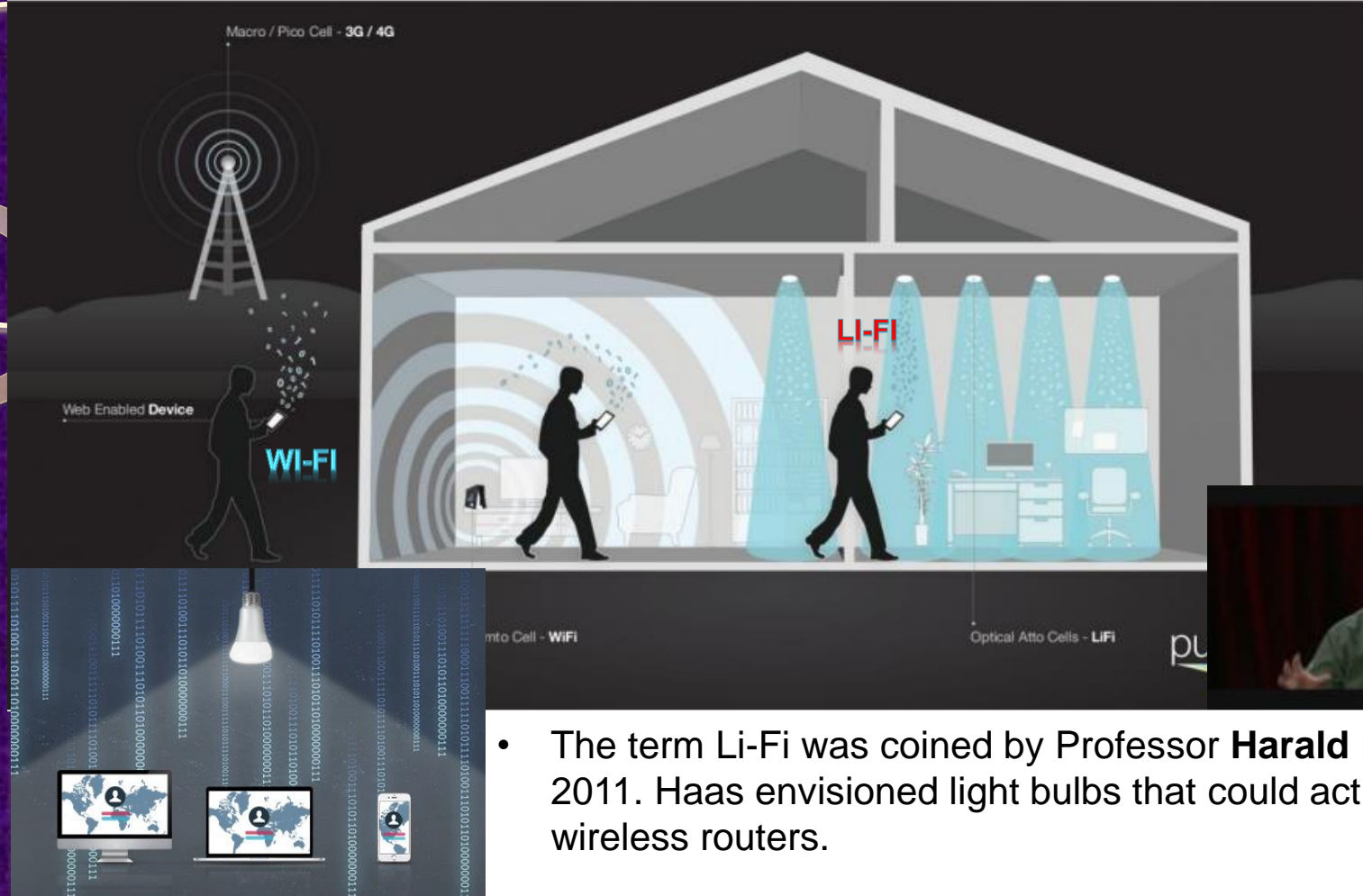

- The term Li-Fi was coined by Professor **Harald Haas** in 2011. Haas envisioned light bulbs that could act as wireless routers.

Li-Fi signals cannot pass through walls, so in order to enjoy full connectivity, capable LED bulbs will need to be placed throughout the home.

Li-Fi and Wi-Fi are quite similar as both transmit data electromagnetically. However, Wi-Fi uses radio waves, while Li-Fi runs on visible light waves.



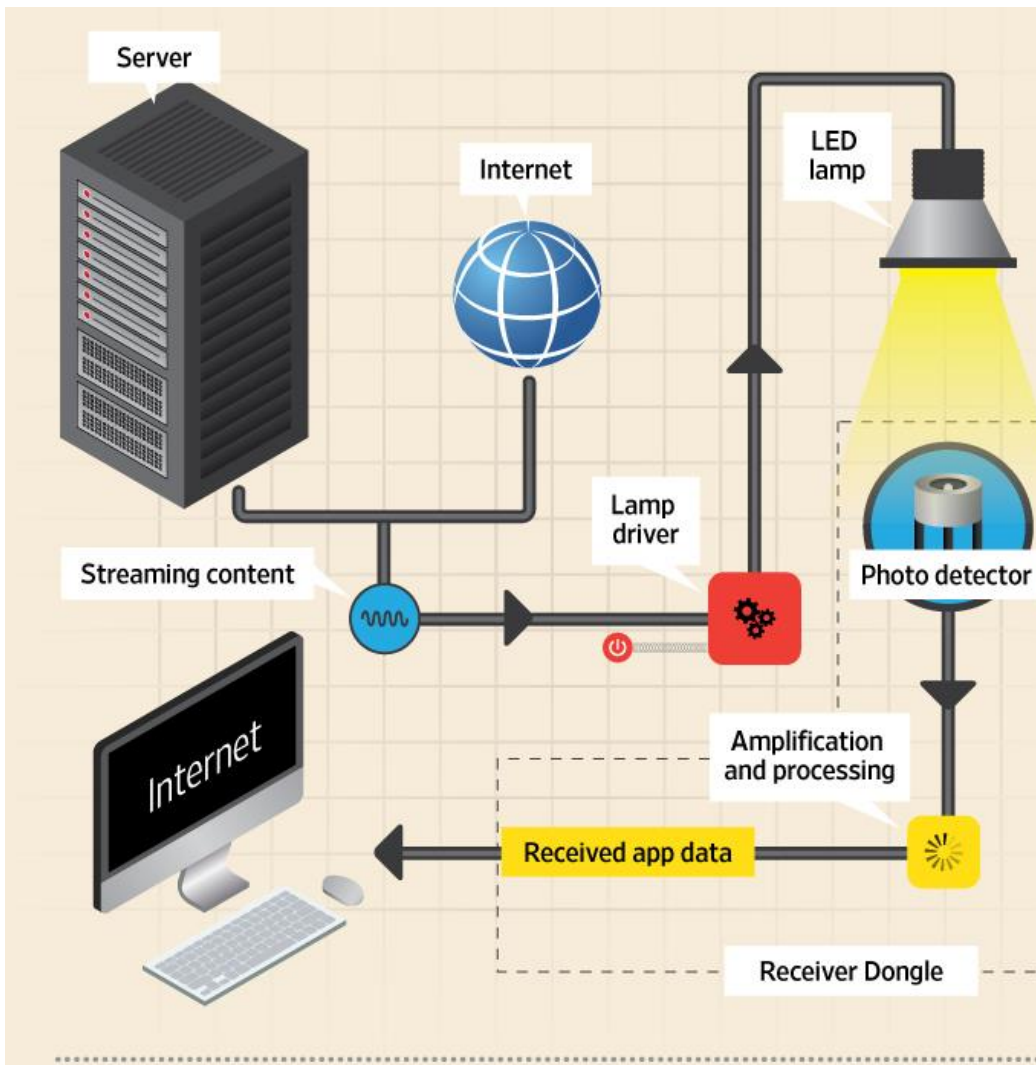

- Data is fed into an LED light bulb (with signal processing technology), it then sends data (embedded in its beam) at rapid speeds to the photo-detector (photodiode).
- The tiny changes in the rapid dimming of LED bulbs is then converted by the 'receiver' into electrical signal.



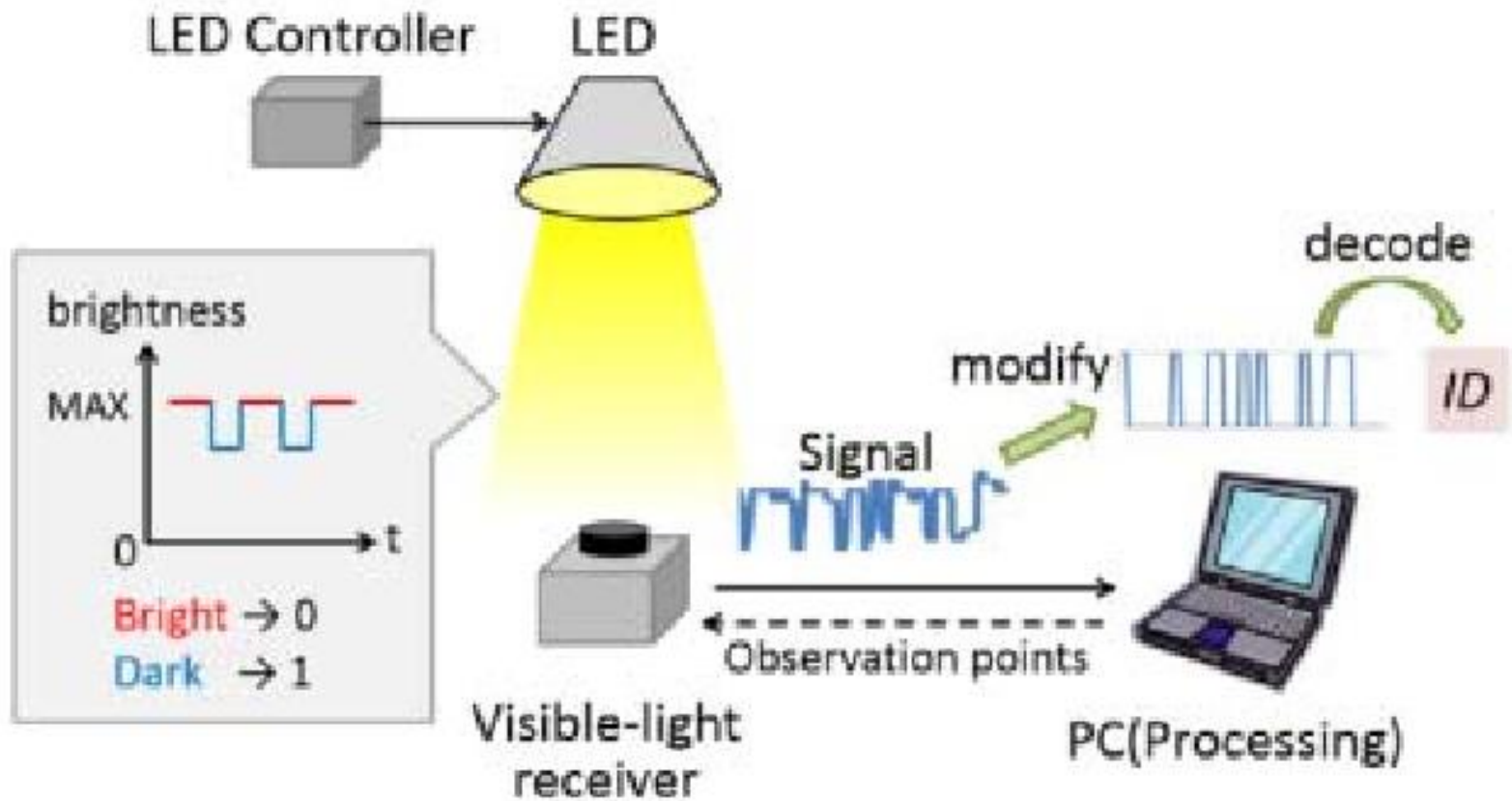

Li-Fi is a Visible Light Communications (VLC) system.

This means that it accommodates a **photo-detector** to receive light signals and a **signal processing** element to convert the data into 'streamable' content.

Infrastructure-to-device communication.

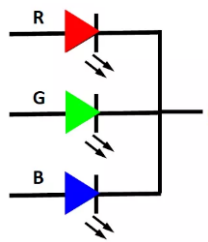
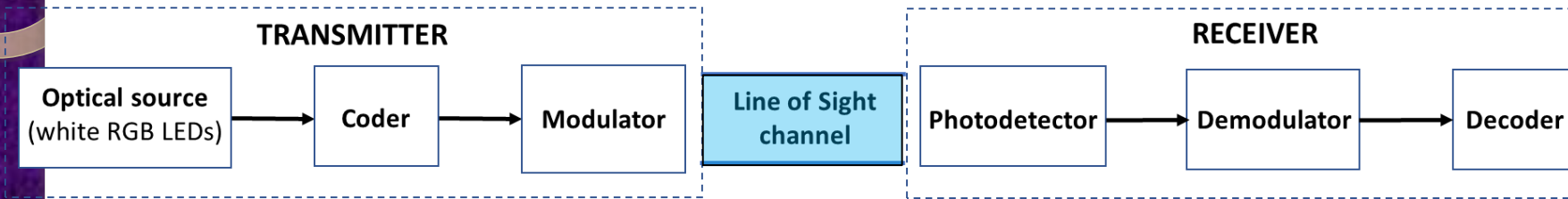
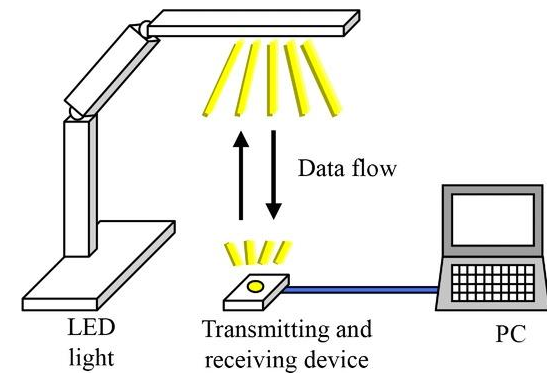

10101001

11011101

10011001

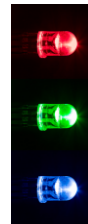

OOK

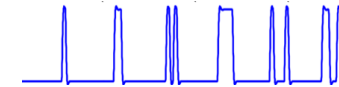
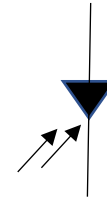

10101001

11011101

10011001

LED luminaires

- room illumination
- position/navigation
- data transmission

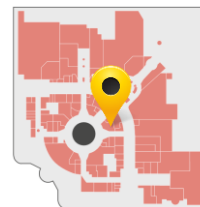
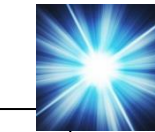

ADVANTAGES/DISADVANTAGES



OF ITS POTENTIAL BENEFITS ARE



Freeing up spectrum: Audio, video, live-streaming makes heavy demand on radio spectrum. If that traffic is diverted to Li-Fi (wherever available), already clogged cellular networks will be relieved of their burden.



Smart lighting: Street lamps can be used to provide Li-Fi hotspots.



Mobile connectivity: Electronic devices such as laptops, smartphones, tablets and others mobile devices can interconnect directly using Li-Fi.



Hospitals: Li-Fi does not result in any electromagnetic interference and will not interfere with medical equipment.



Transportation: Headlights and tail lights in vehicles are moving to LED and so are street lights. Li-Fi can be used for vehicle-to-vehicle and vehicle-to-roadside communications for road safety and traffic management.

DISADVANTAGES



Light cannot pass through walls so mobility is an issue.



Li-Fi cannot be achieved without a light source.



THE INTERNET OF THINGS

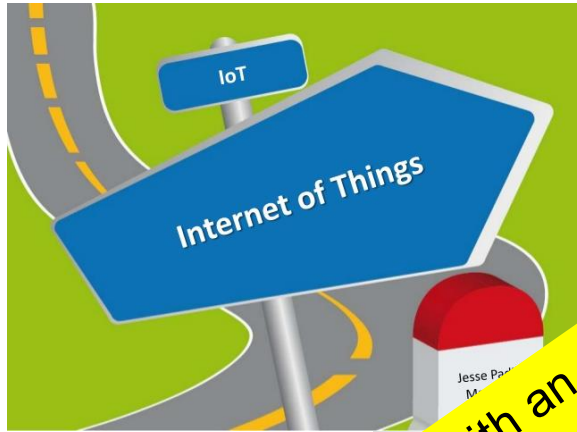

connecting any device with an on and off switch to the Internet (and/or to each other)

The integration of IoT devices and Li-Fi will provide a wealth of opportunities. For example, shop owners could transmit data to multiple customers' phones quickly, securely and remotely.



Speed
Latency
Capacity

1G	2G	3G	4G	5G
1981	1992	2001	2010	2020(?)
2 Kbps	64 Kbps	2 Mbps	100 Mbps	10 Gbps
Basic voice service using analog protocols	Designed primarily for voice using the digital standards (GSM/CDMA)	First mobile broadband utilizing IP protocols (WCDMA / CDMA2000)	True mobile broadband on a unified standard (LTE)	'Tactile Internet' with service-aware devices and fiber-like speeds
				

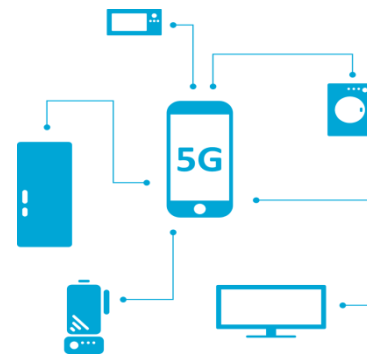
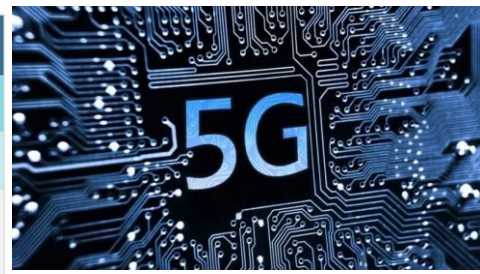

5G will drive the future networked society

5G is expected to use various technologies such as LTE (Long Term Evolution), WiFi, Ultra Wide Band (UWB) and VLC to ensure permanent coverage of the communication network without any interruption of service.



x 1,000

increasing wireless capacity
1,000 times



7 Billion

connecting
7 billion people



7 Trillion

connecting
7 trillion "things"



90%

saving 90% energy



0 Latency

perceiving zero downtime



Visible Light Communication



Indoors environments

- Light atmospheric absorption
- shadows
- light dispersion
- influence of other light sources

- Internet service distribution
- Navigation techniques

3 Gbps

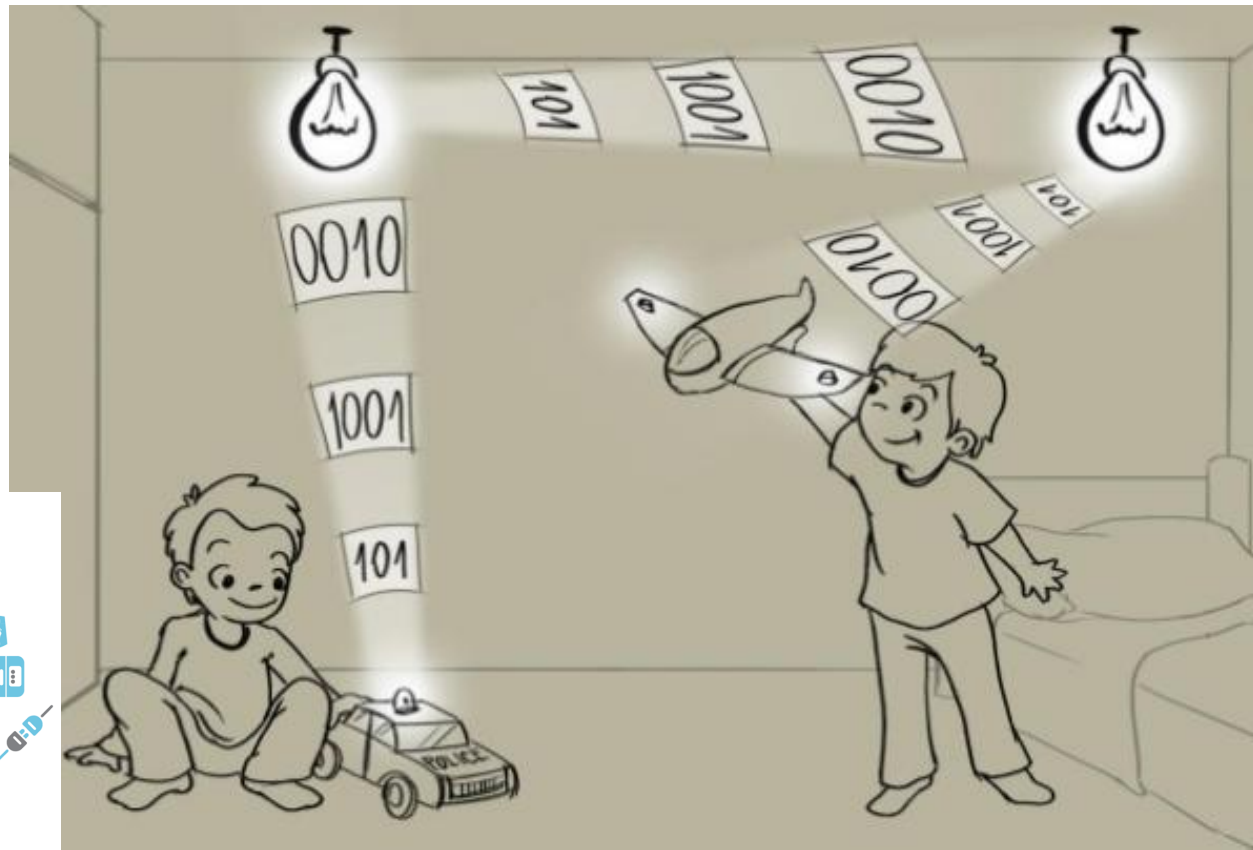
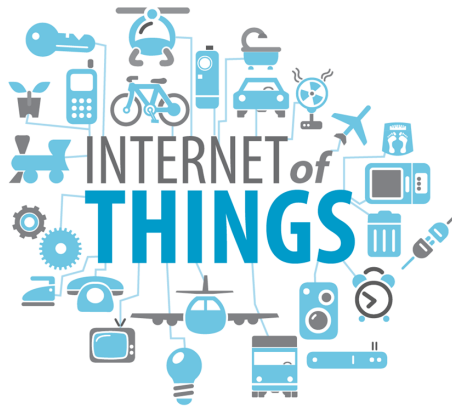

Communication with light enables a true **Internet of Things** as consumer devices that are equipped with LEDs could be transformed into interactive communication nodes,"

"We are not just talking about sensors, smartphones and appliances. This easily could include toys that have LEDs, creating an **Internet of Toys** in which toys can be accessed, monitored and acted on remotely."

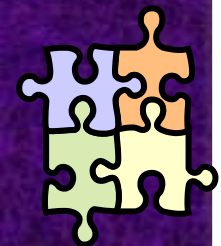

Visible Light Communication Technology: Indoor Localization



Manuela Vieira



Manuel Augusto Vieira

Paula Louro



Pedro Vieira



Lisbon

GPS

How does it work????



1 Wireless phone receives signals from GPS satellites and calculates the phone's location

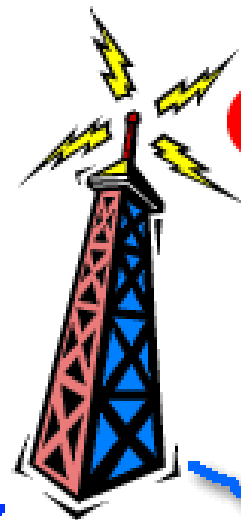

3 The voice call and location data are received at the antenna, and forwarded to the carrier's switch

4 The carrier forwards the voice and location information to the PSAP

2 handset or vehicle places 911 call, transmitting both a voice signal and the location data

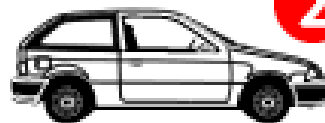

VLC: Visible Light Communication

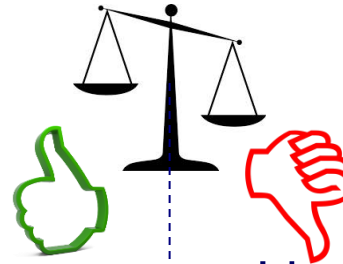

- Dual operation:
light + communication
- Infrastructure advantage
- Increased bandwidth
- Free and non-regulated spectrum
- Negligible power
- Inexpensive
- Security
- Harmless to human health
- No **EM** interference

- Line of sight technology (LoS)
 - Distance: 1 – 100 m
 - Obstructions
 - Atmospheric absorption
 - Shadows
 - Light dispersion
 - Influence of other light sources

INDOOR USE



- Coder/decoder device
I_R/RGBV/UV channels;

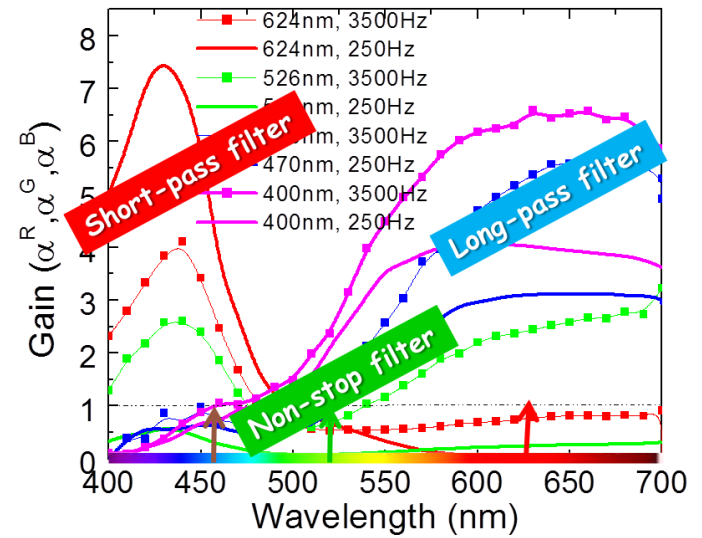
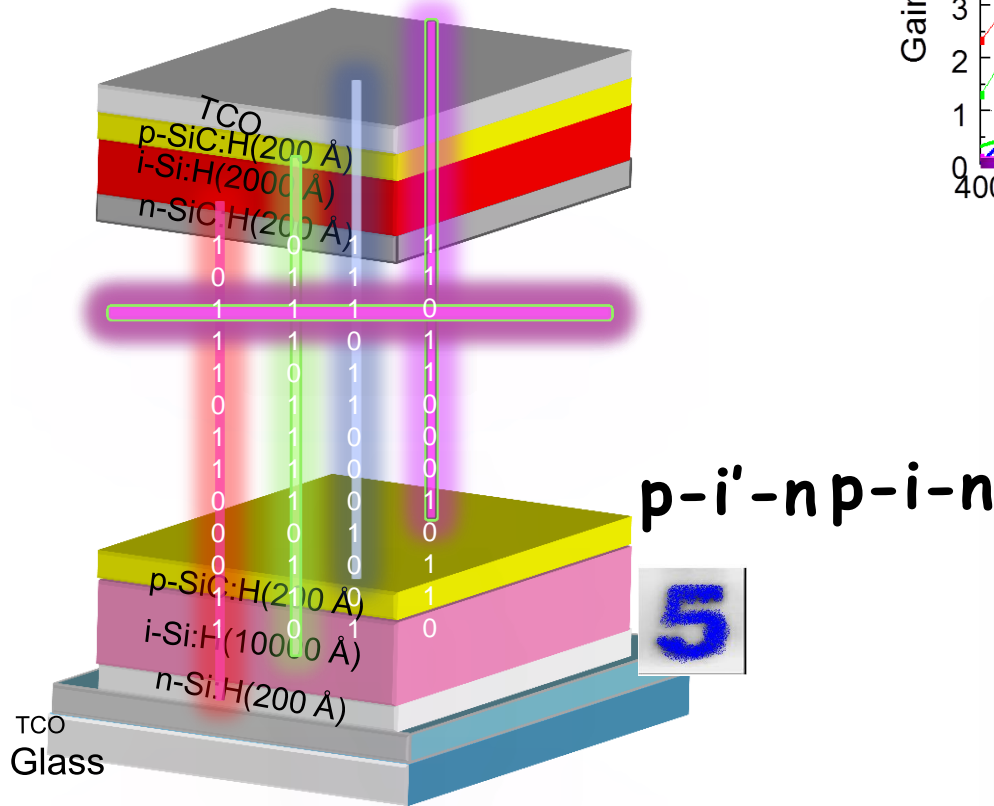

- Light-to-dark sensitivity depends on the carbon concentration
- Color recognition depends on the applied bias
- Light filtering depends on the bias wavelength and side
- WDM device
RGB channels; 6000bps



- Optical wireless communication has been widely studied during the last years in short-range applications.
- Therefore, communications within personal working/living spaces are highly demanded.
- Multi-device connectivity can tell users, from any device, where they are, where they need to be and what they need to do when they get there.
- In future accurate indoor positioning might not be viable by sole utilizing RF communications.
- To support people's wayfinding activities in unfamiliar indoor environments, a method able to generate ceiling landmark route instructions using VLC is proposed.
- It can be easily used in indoor environments using the existing LED lighting infrastructure with few modifications. This means that the LEDs are twofold by providing illumination as well as communication.

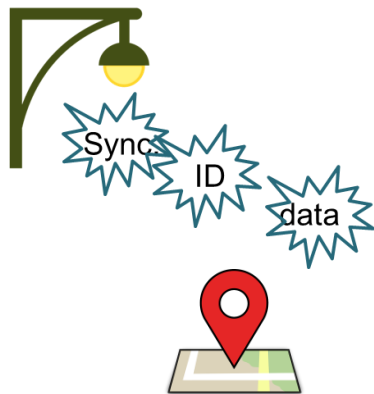

- The dynamic navigation system is composed of several transmitters which send the map information and path messages required to wayfinding.
- Mobile optical receivers, using joint transmission, extracts their location to perform positioning and, concomitantly, the transmitted data from each transmitter.
- To synchronize the signals from multiple LEDs, the transmitters use different ID's, such that the signal is constructively at the receiver.
- Bidirectional communication between the emitters and the receivers is available in strategic optical access point (Li-Fi zone).
- The system is composed by the transmitter and the receiver modules located, respectively, at the infrastructures and at the mobile users.

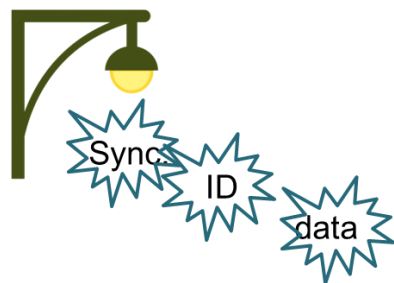
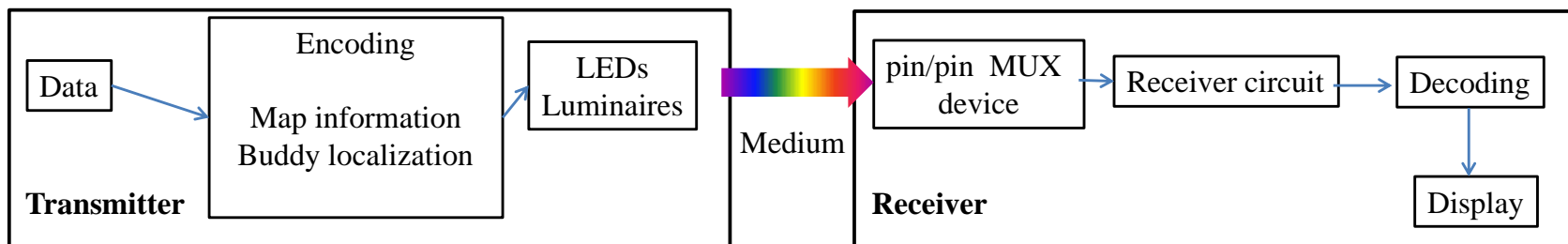

- The system is a self-positioning system in which the measuring unit is mobile.
- ✓ Each luminaire for downlink transmission become a single cell in which the optical access point (AP) is located in the ceiling.
- ✓ Data from the sender (the map information and the path messages necessary to wayfinding) is encoded, modulated and converted into light signals emitted by the transmitters.

Transmitter

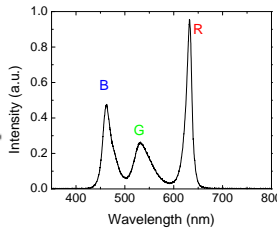
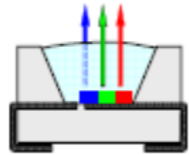

- Tetra-chromatic white sources are used providing a different data channel for each chip.

Receiver

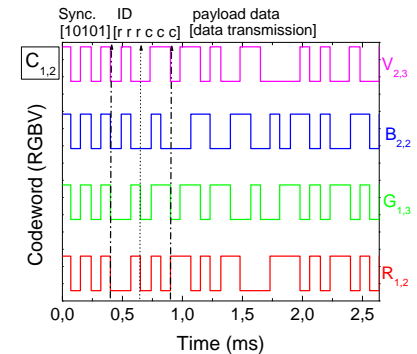
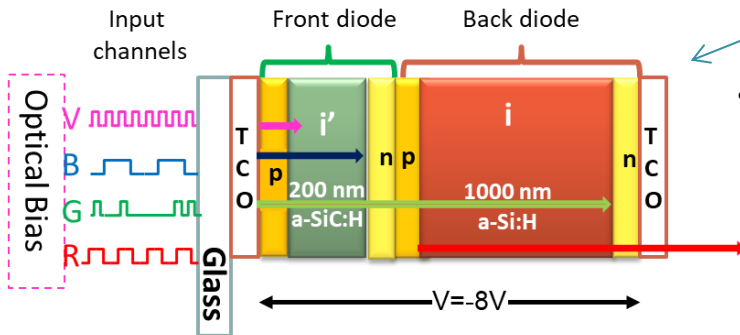

- Receiver modules includes a photodetector based on a tandem a-SiC:H/a-Si:H pin/pin light controlled filter that multiplexes the different optical channels, performs different filtering processes (amplification, switching, and wavelength conversion) and finally decodes the encoded signals, recovering the transmitted information

Transmitter / Receiver of VLC

LED

ID data transmit with fast blinking

Coder/decoder device

Bit decode

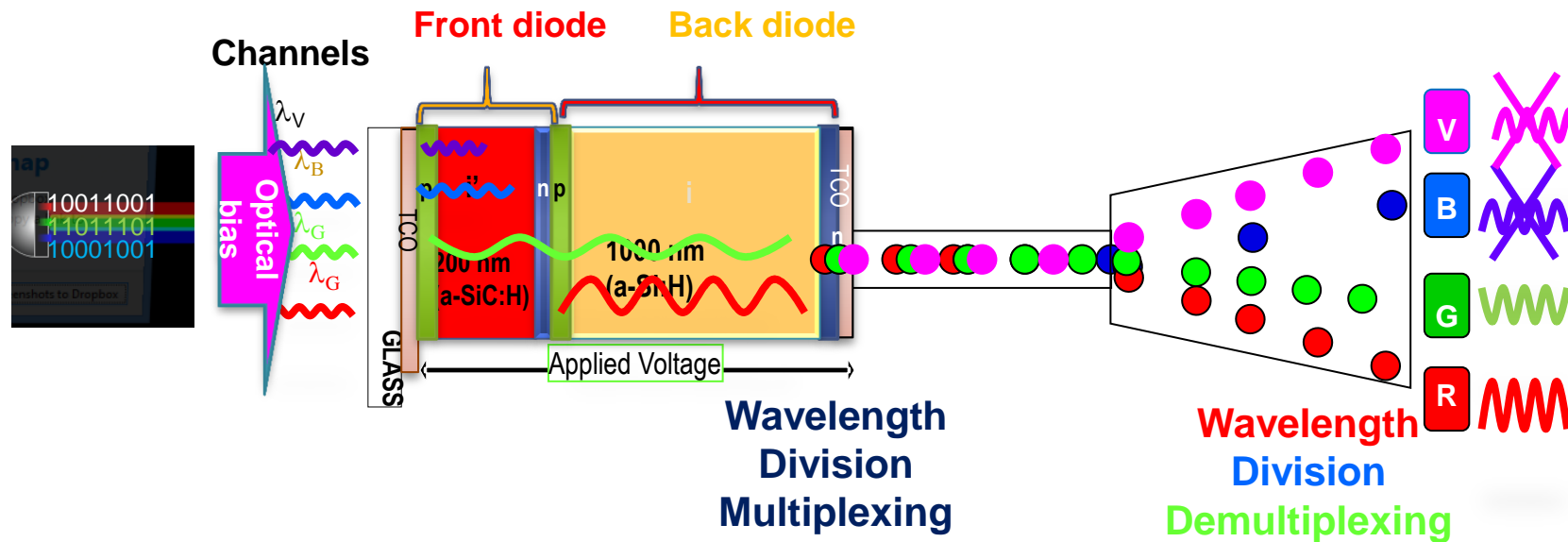

- The device acts as an active filter, under irradiation.
- The gain is higher than the unity for wavelengths above 500 nm and lower for wavelengths below, resulting in an amplification of the **green** and **red** spectral ranges and quenching of the **violet/blue** ones.
- As the wavelength increases, the signal strongly increases. This nonlinearity is the main idea for the decoding of the MUX signal at the receiver.

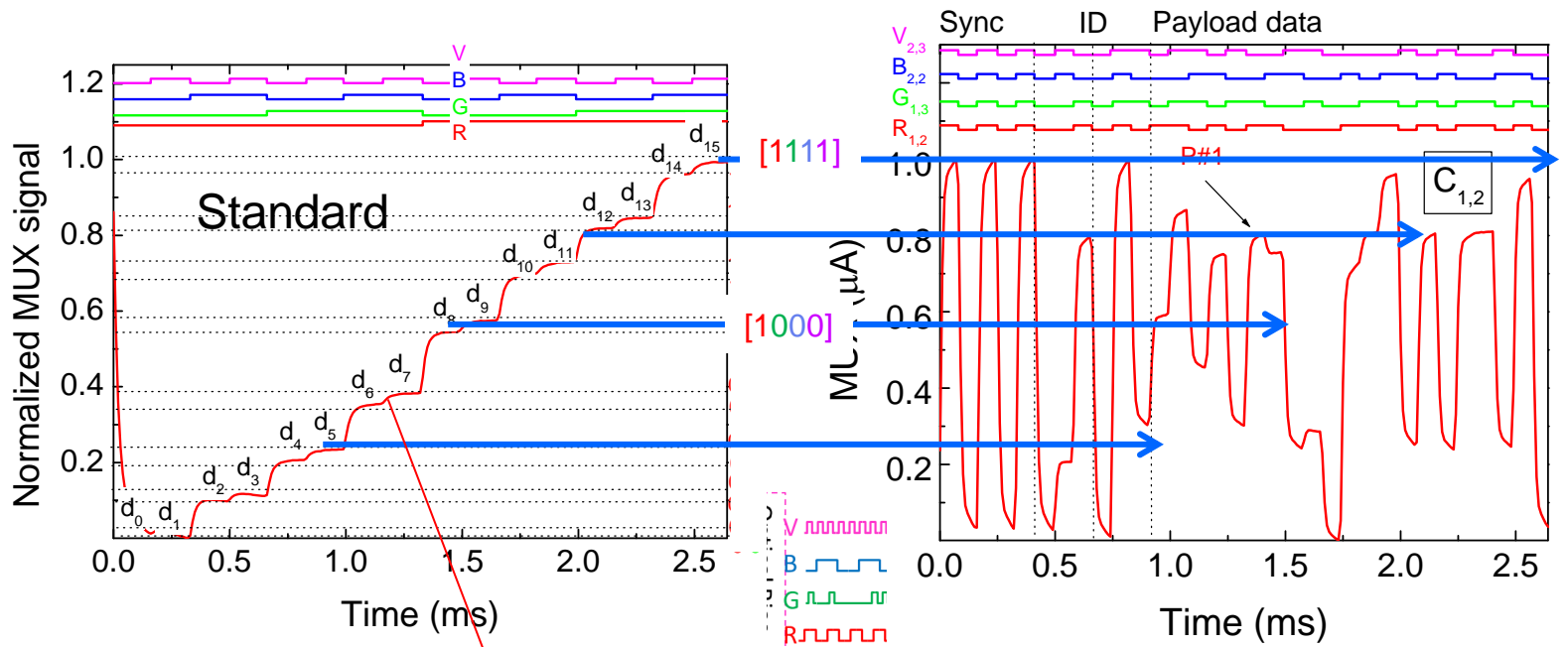

- 2^4 ordered levels pondered by their optical gains are detected and correspond to all the possible combinations of the *on/off* states.
- By assigning each output level to a 4-digit binary code (weighted by the optical gain of the each channel), $[X_R, X_G, X_B, X_V]$, with $X=1$ if the channel is *on* and $X=0$ if it is *off*, the signal can be decoded.
- Comparing the calibrated levels with the different generation levels in the same frame of time, a simple algorithm was used to perform 1-to-32 demultiplexer function and to decode the multiplex signals.

- ✓ To encode the messages an on-off keying (OOK) modulation scheme was used.
- ✓ The OOK is considered suitable for applications in which the communication distance is more important than data rate.
- ✓ The codification of the optical signals is synchronized and includes the information related to the ID position of the transmitters and the message to broadcast
- ✓ The codification of the optical signals is synchronized and includes the information related to the ID position of the transmitters and the message to broadcast.
- ✓ Each frame is divided into several blocks depending on the kind of transmitter. We assigned the first block the synchronization (SYNC) in a [10101] pattern the second to the ID of the transmitter and the last one to the message to transmit (Payload Data). A stop bit is used at the end of the each frame.

Data frame structure.

Representation of one original encoded message, in a time slot

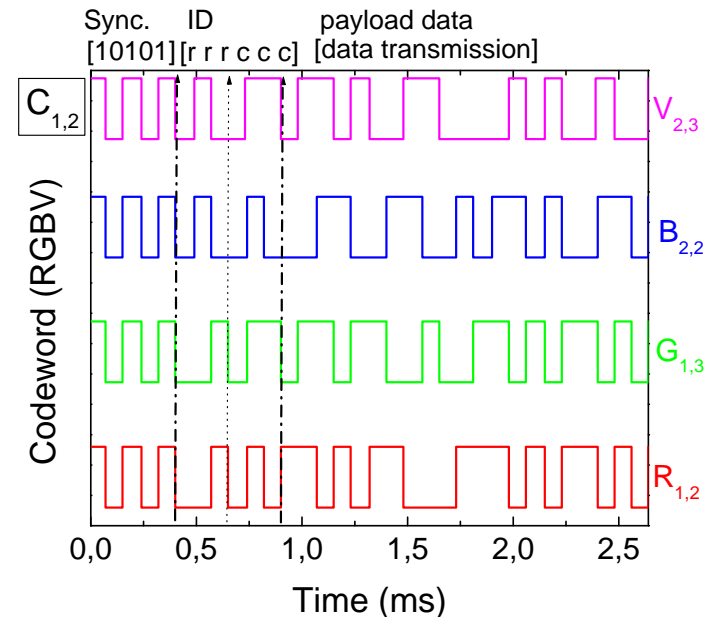

MUX/DEMUX SIGNALS

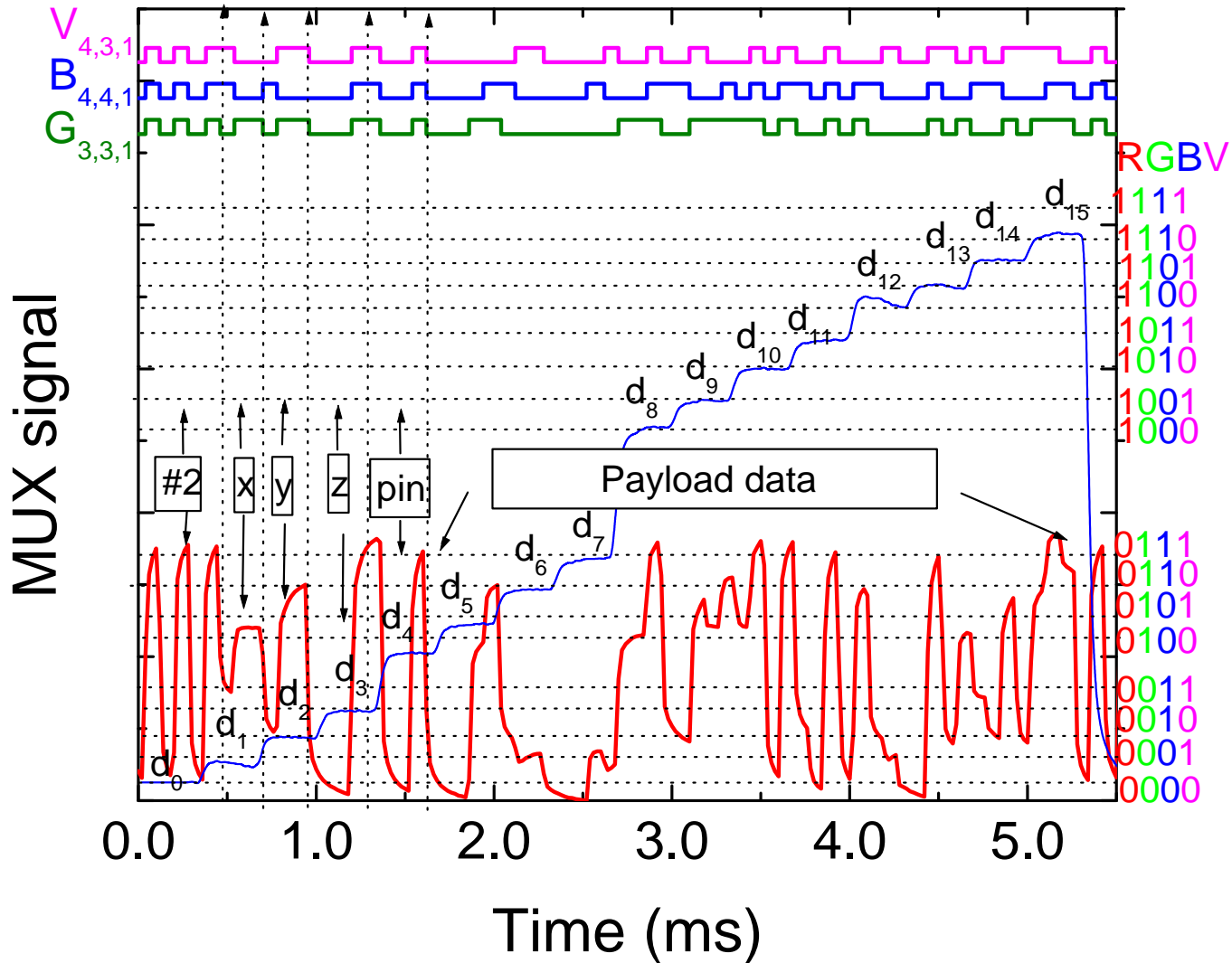

- Example of a MUX/DEMUX signals received. On the top the received information is decoded. The MUX signal of the calibrated cell in the same frame of time is superimposed.

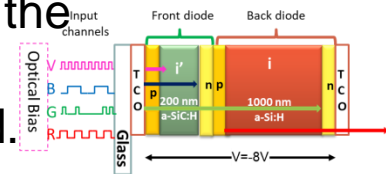

INDOOR APPLICATIONS



The **indoor environment** chosen is an airport.

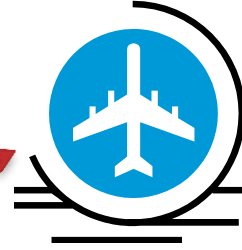

- LED bulbs work **as transmitters**, broadcasting the information. An **optical receiver extracts its location** to perform positioning and, concomitantly, **the transmitted data** from each transmitter.
- The **traveler navigates from outdoor to indoor**. Equipped with a receiver, after the check-in (main entrance) he passes through the control zone and depending on the **available time** for boarding he can **shop**, has a **light meal** or **rest**.
- **After registration**, he sends to the central controller a message request in order to add, in the available time, **customized points of interest, routes from restaurants, shops, gates, halls to boarding or the right track**.
- During his path, the passenger **is advised how to reach its destination** and the possibility **to use location-based advertising** (available selection of goods, advices and restaurants to take a break).
- Two topologies were considered: the **square** for the main hall and the **hexagonal** for the marketing zones.



VLC SCENARIO

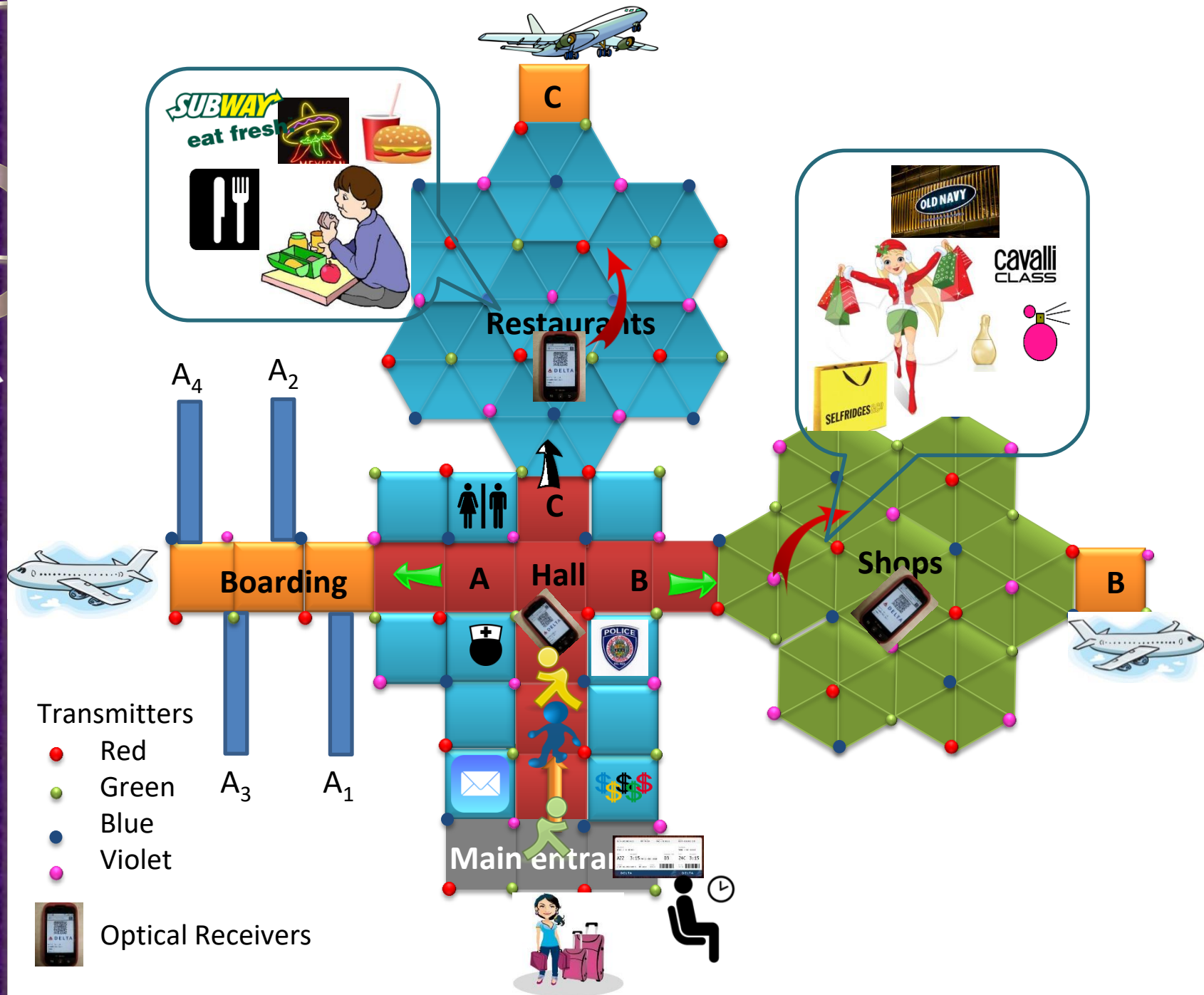

EMITTERS FOR LARGE ENVIRONMENTS

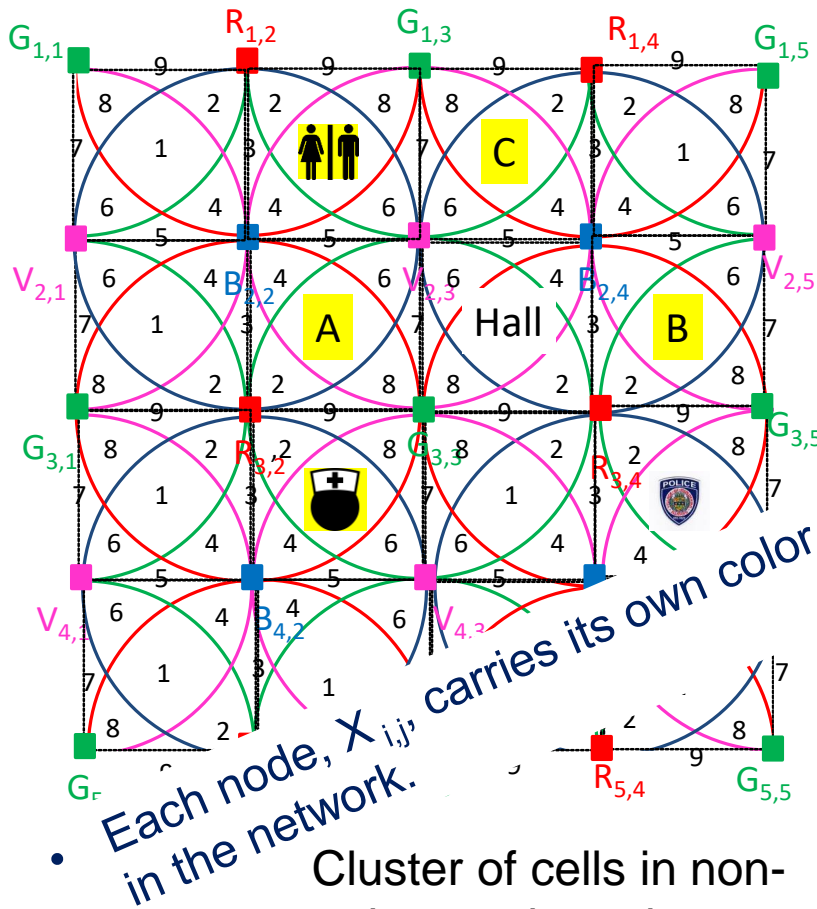

Clusters of cell in an orthogonal topology (square).



Cluster of cells in non-orthogonal topology (diamond).

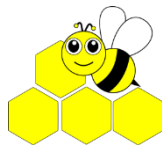
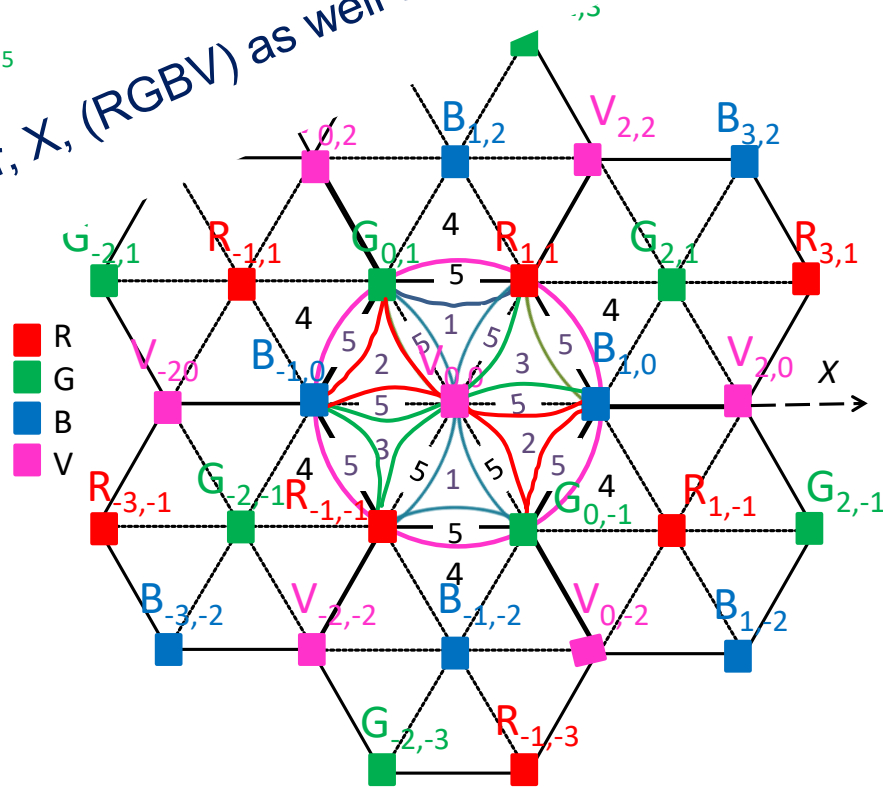

Footprint regions	#1	#2	#3	#4	#5	#6	#7	#8	#9
Square topology	RGBV	RGB	RB	RBV	BV	GBV	GV	RGV	RG
Hexagon topology	RGV	GBV	RBV	RGB	RGBV	-	-	-	-



OOK MODULATION SCHEME

- An on-off keying modulation scheme was used. In OOK, the data bits 1 and 0 are coded by turning each LED *on* and *off* respectively.
- To create a communication protocol to ensure the required system performance and overcome the technology constraints, a 32 bits data frame was designed.
- The first five bits are used for time synchronization. The same synchronization header [10101], in an ON-OFF pattern, is imposed simultaneously to all the emitters.
- Each colour signal (RGBV) carries its own ID-BIT. The next bits give the coordinates of the emitter inside the array ($X_{i,j}$). Cell's IDs are encoded using a binary representation for the decimal number.
- The last bits, in the frame, are reserved for the message send by the X_{ij} node (payload data). A stop bit is used at the end of each frame

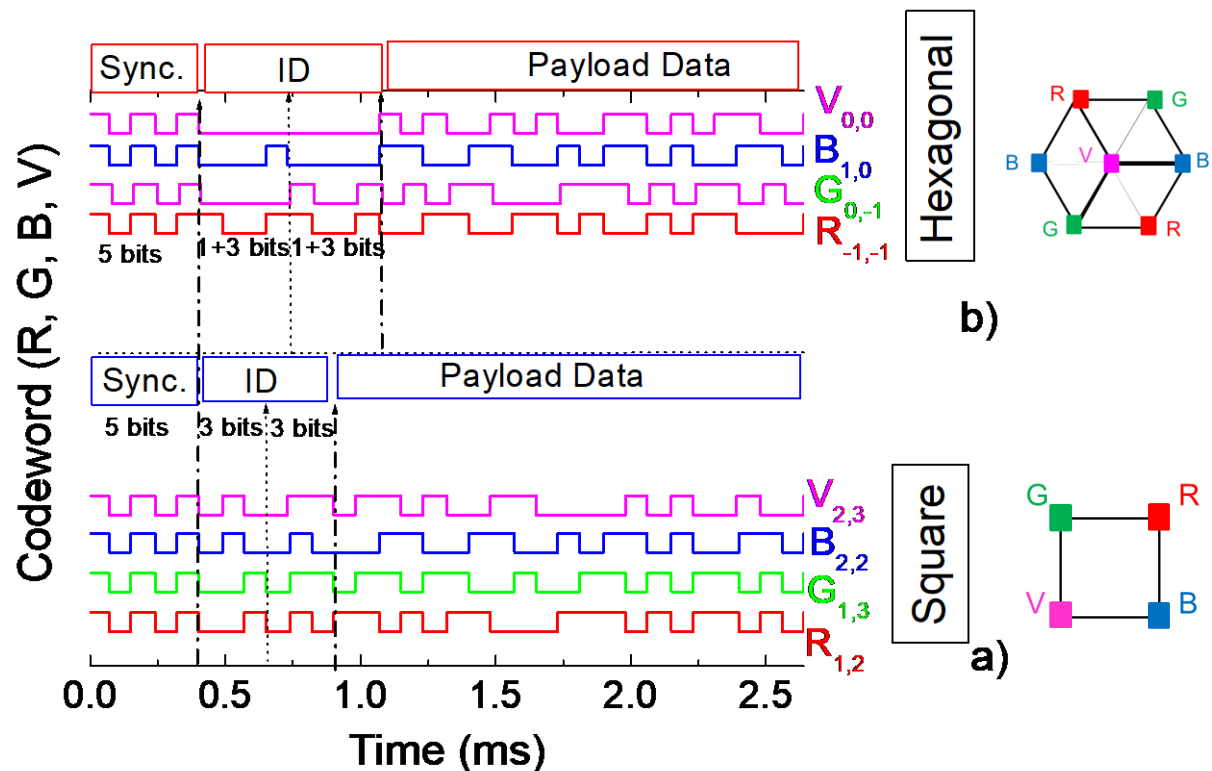
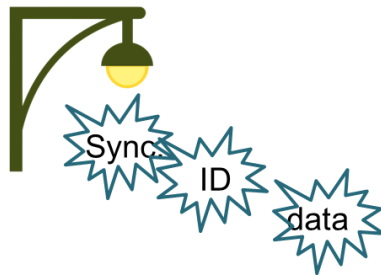

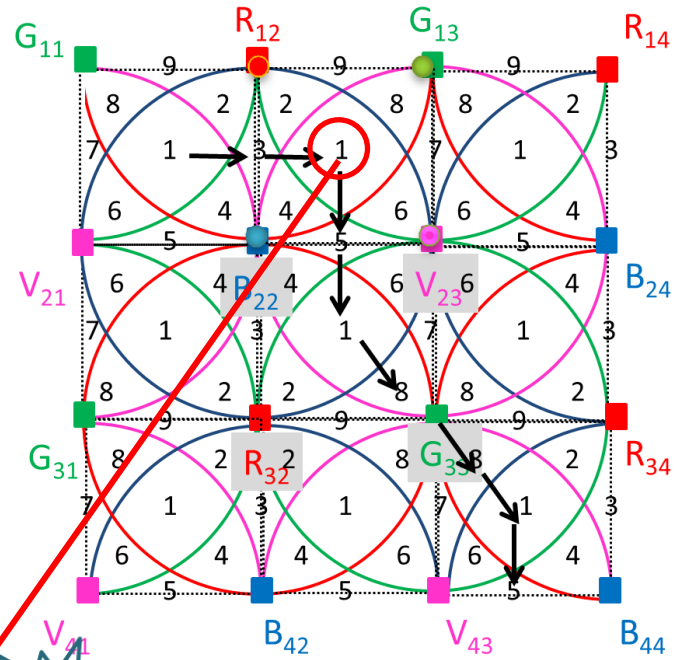
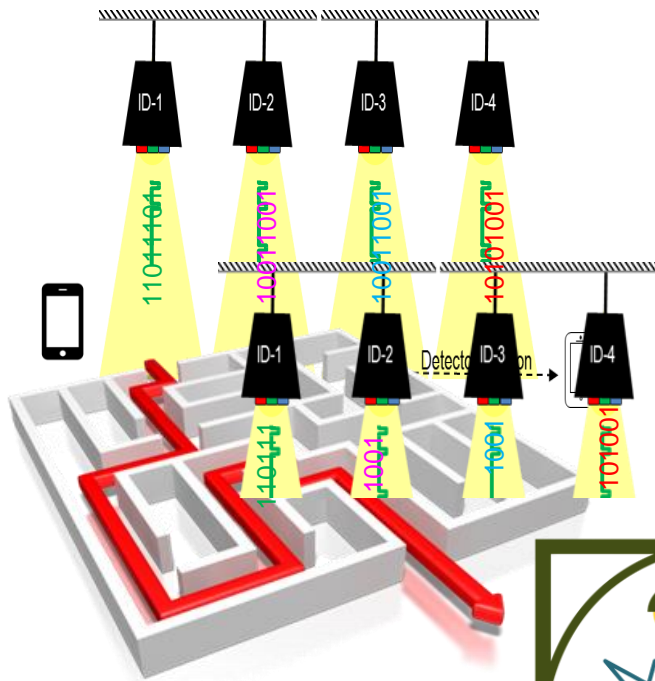

- The input of the aided navigation system is the MUX signal, and the output is the system state estimated at each time step (Δt).
- An on-off keying modulation scheme was used

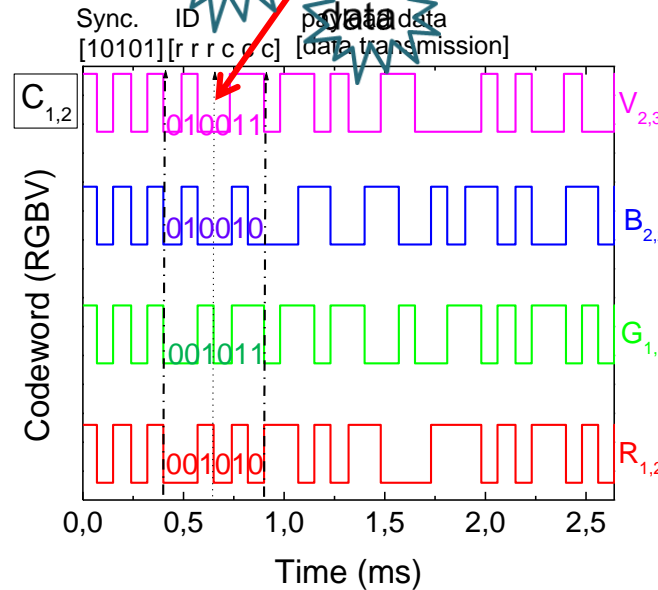

ID: $C_{1,2}$, #P1

R_{12} [10101 001 010...]
 G_{13} [10101 001 011...]
 B_{22} [10101 010 010...]
 V_{23} [10101 010 011...]

NAVIGATION DATA BITS

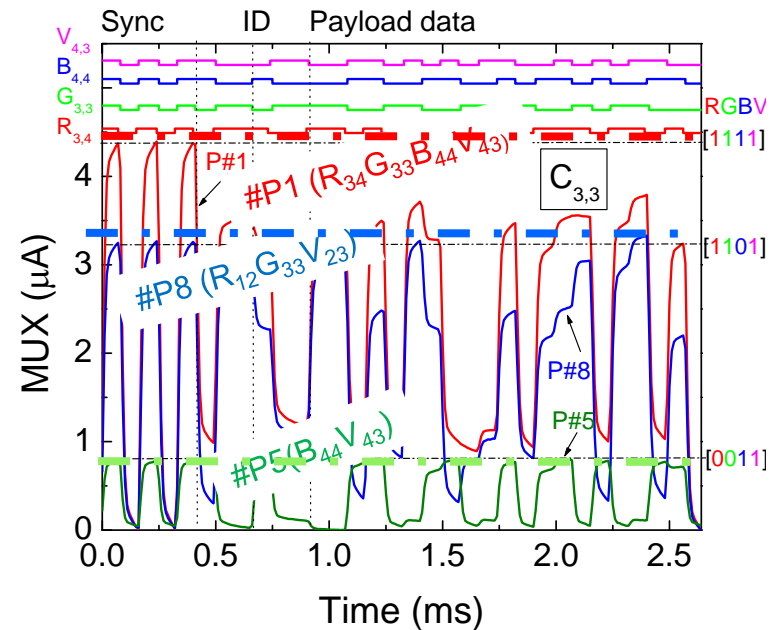
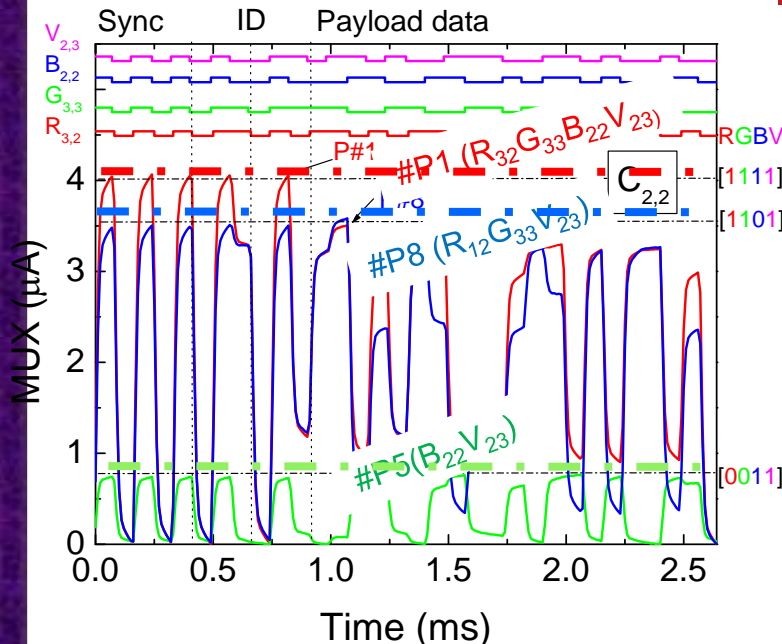
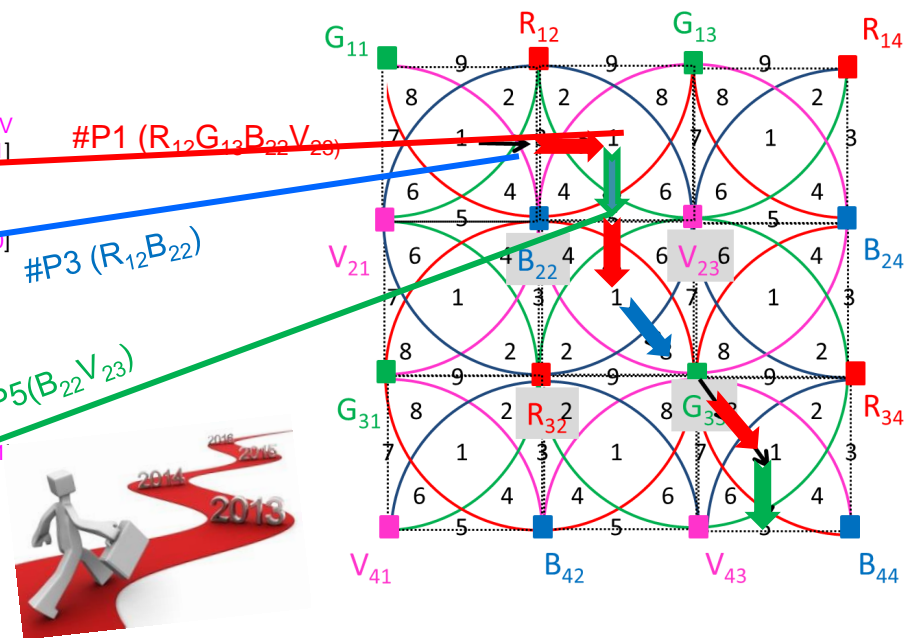
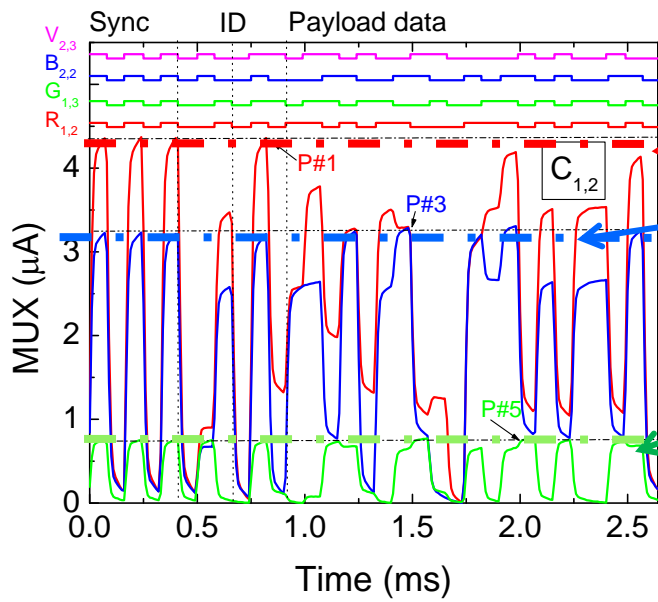

- As the receiver moves between generated point regions, the received information pattern changes. The transition actions are correlated by calculating the ID position codes in successive instants.

LED-BASED NAVIGATION SYSTEM

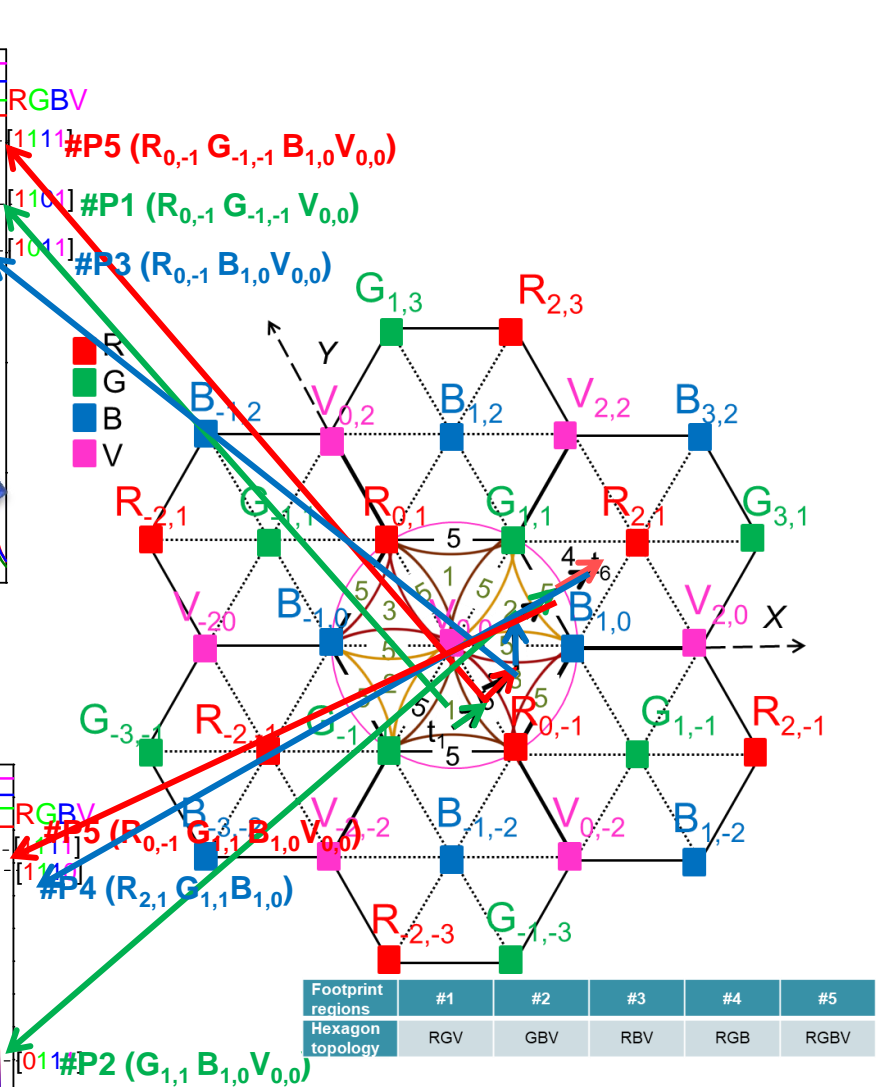
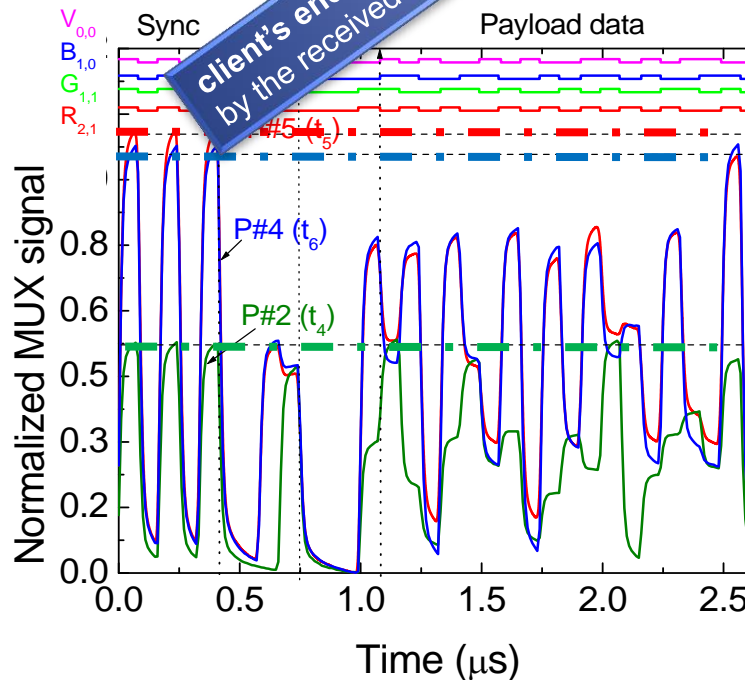
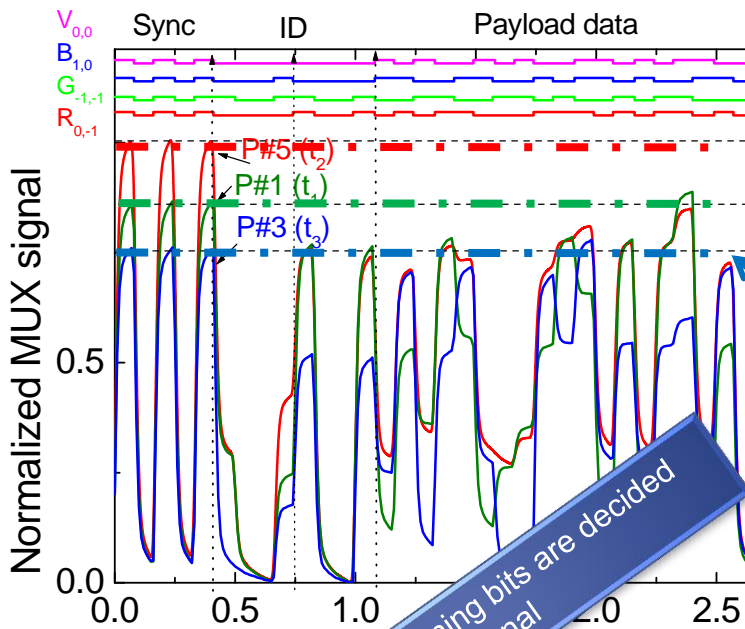

LED-AIDED NAVIGATION SYSTEM

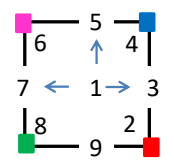
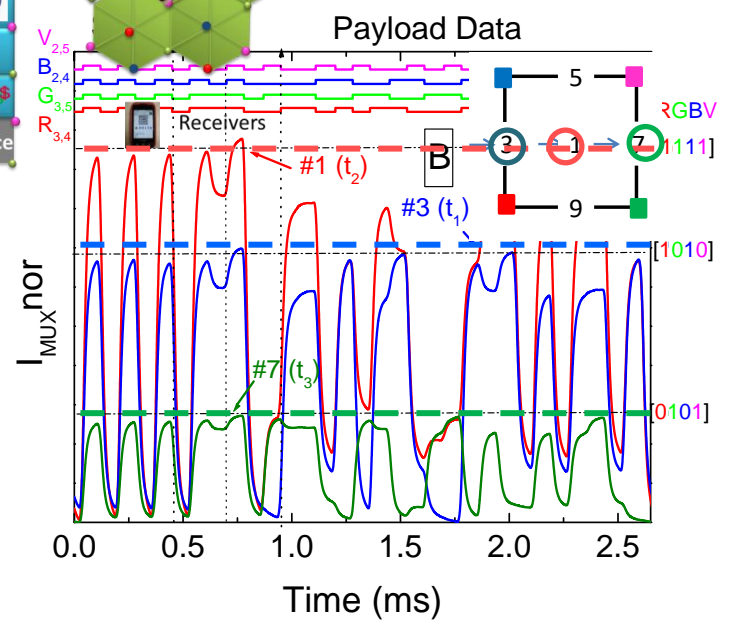
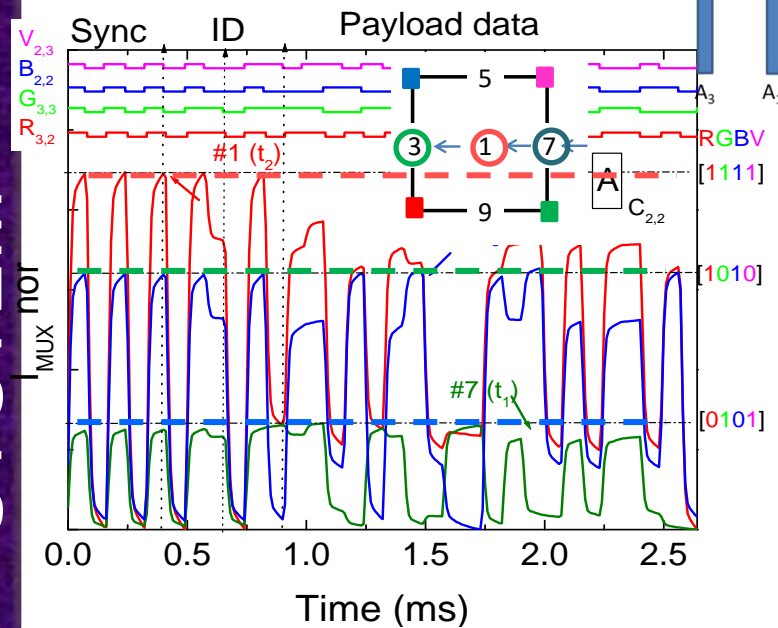
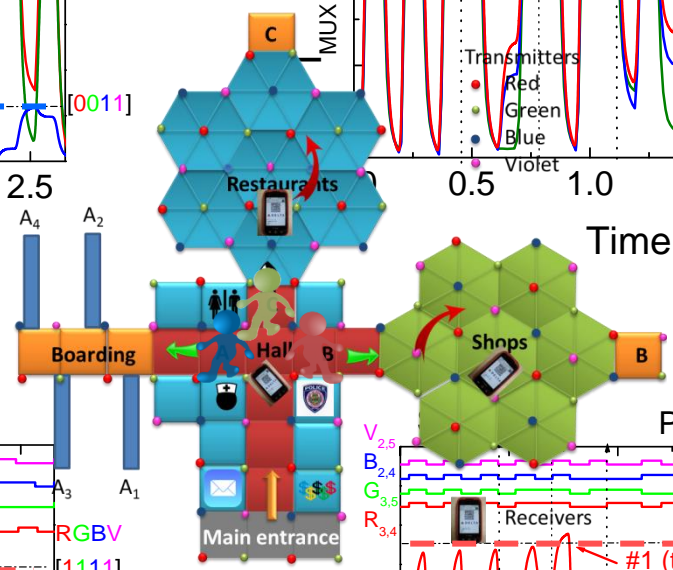
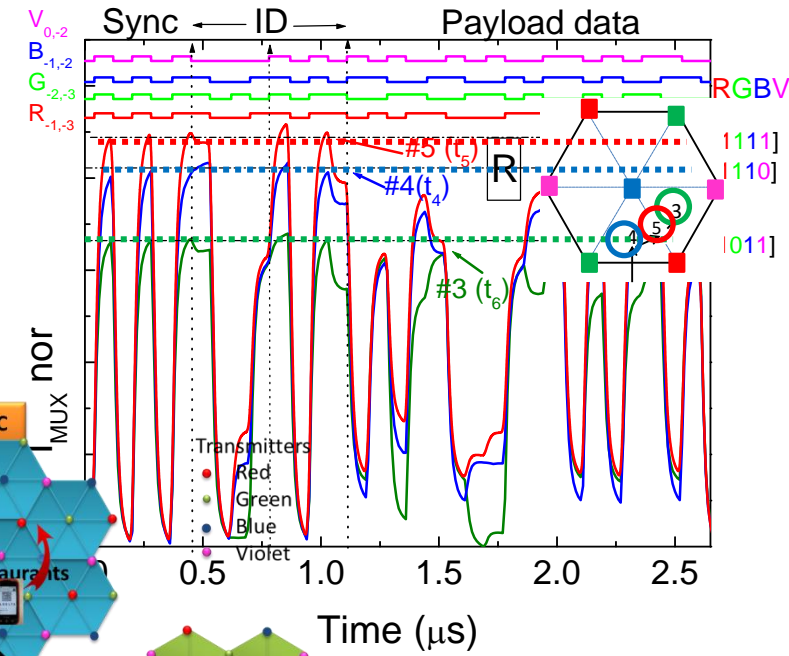
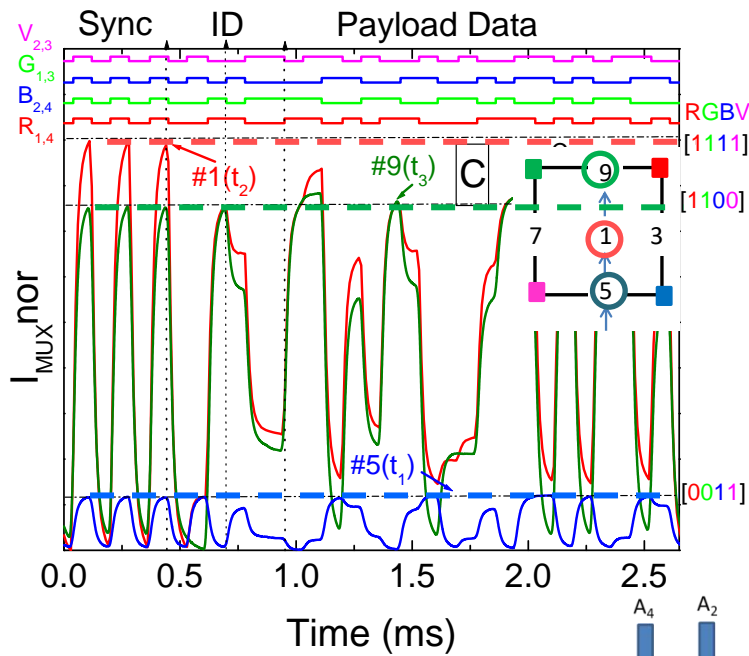

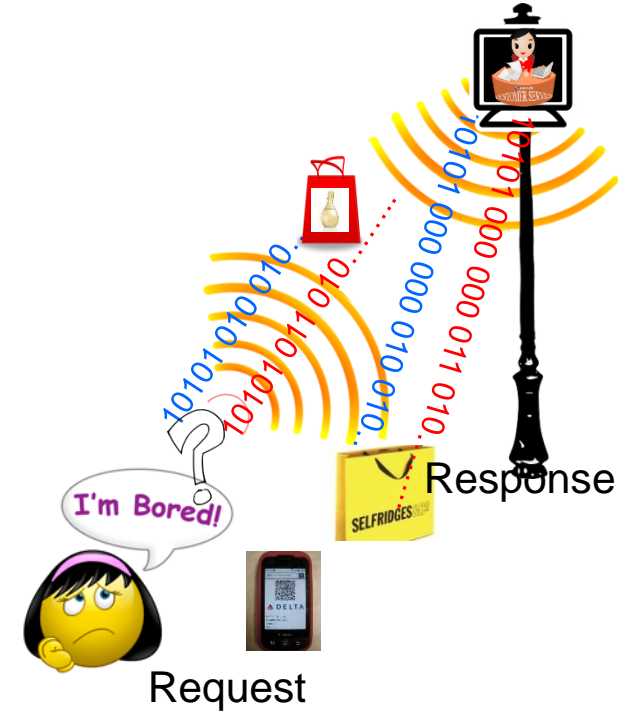
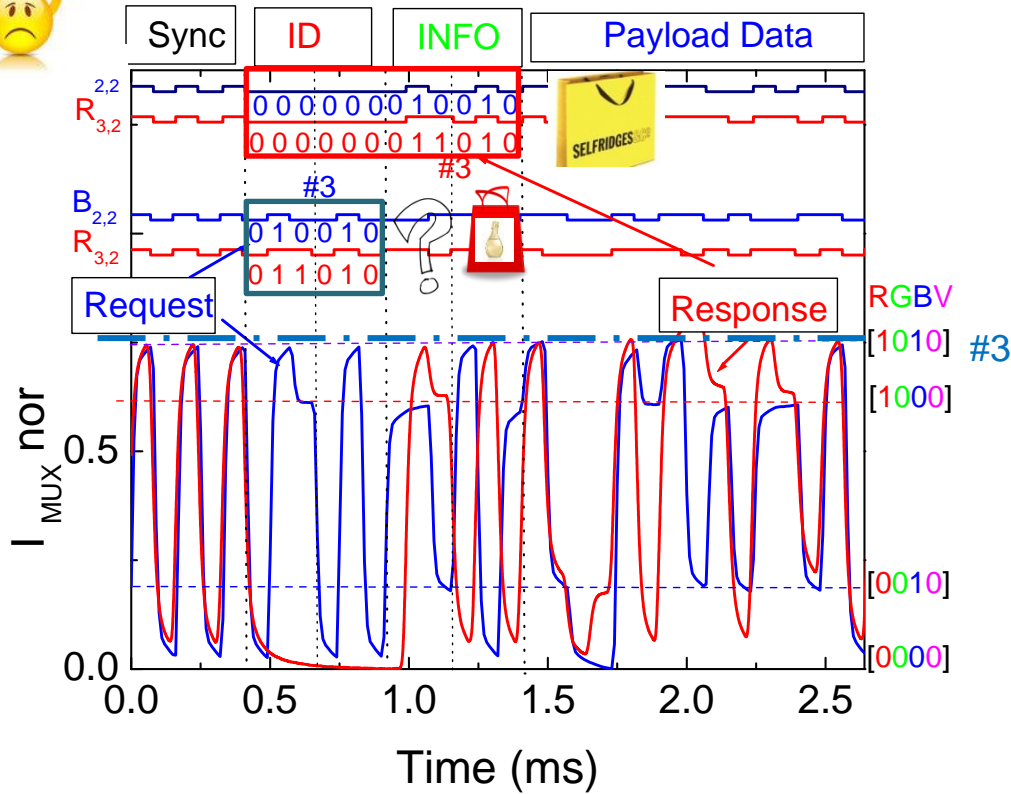

- Bi-directional communication between VLC emitters and receivers at a handheld device can be established through a control manager linked to an indoor billboard.
- Using a white polychromatic LED as transmitter, the receptor sends to the local controller a “request” message with its location (ID) and adds its needs for the available time. For route coordination, the local controller emitter sends the “response” message.
- Each ceiling lamp broadcasts a message with its ID and advertising which is received and processed by the receiver.

- A coupled data transmission and indoor positioning was presented. To transmit the data, an On-Off Keying code was used. Two cellular topologies, for the ceiling plans, were used: the square and the hexagon.

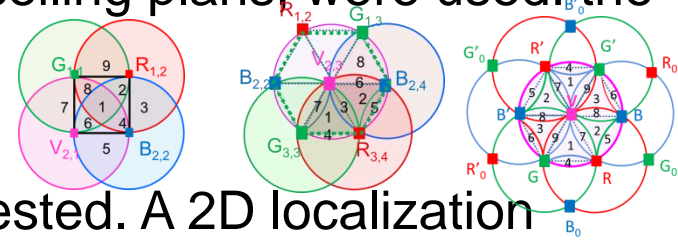

- Fine-grained indoor localization was tested. A 2D localization design, demonstrated by a prototype implementation was developed.

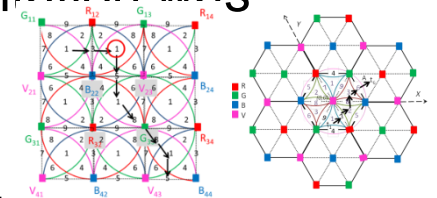

- A detailed analysis of the characteristics of various components within the VLC system were discussed

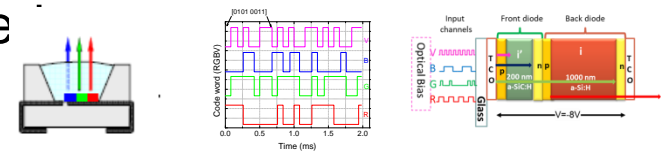

- Results showed that it is possible not only to determine the position of a mobile target inside the unit cell but also in the network and concomitantly to infer the travel direction along the time.



- For future work, by using multiple emitters and receivers, the transmission data rate through parallelized spatial multiplexing can be improved.



Geolocation and Wayfinding Services Using Visible Light Communication

- A dynamic LED-assisted positioning and navigation VLC system is proposed.
- A 3D model for the building is established.
- The transmitted information, indoor position, motion direction as well as bi-directional communication are determined.

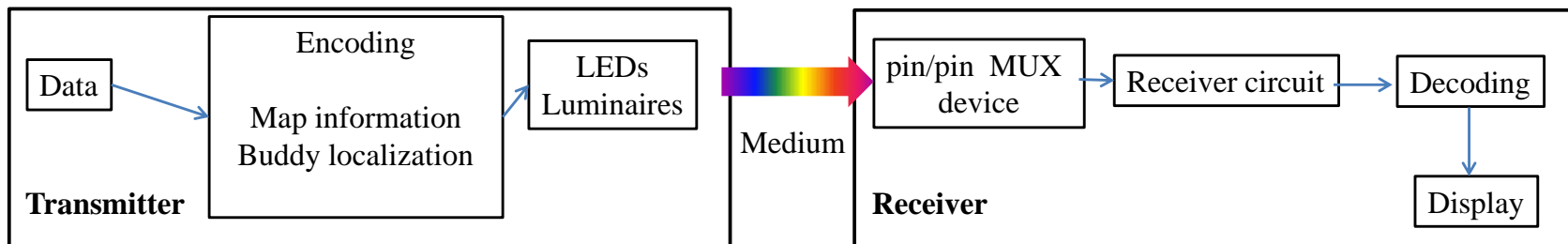

The **indoor environment** is a shopping center with several floors.

When we are looking for the shortest route to a place, we want to be guided on a direct, shortest path to our destination.

- The ground floor is level 0, and the user can go both below and above from there.
- They navigate from different outdoor connections to indoor. Depending on the time available, they can find a friend, shop, have a meal or rest.
- When arriving, they notify the controller manager (CM) of their location (x,y,z) , asking for help to find the best way for their needs.
- Each user sends to the CM a message request in order to add, in the available time, customized points of interest, or the right track to a given location or meeting point.
- A code identifies each user.
- During his path, the user is advised how to reach a friend or destination and also from the possibility to use location based advertising services.

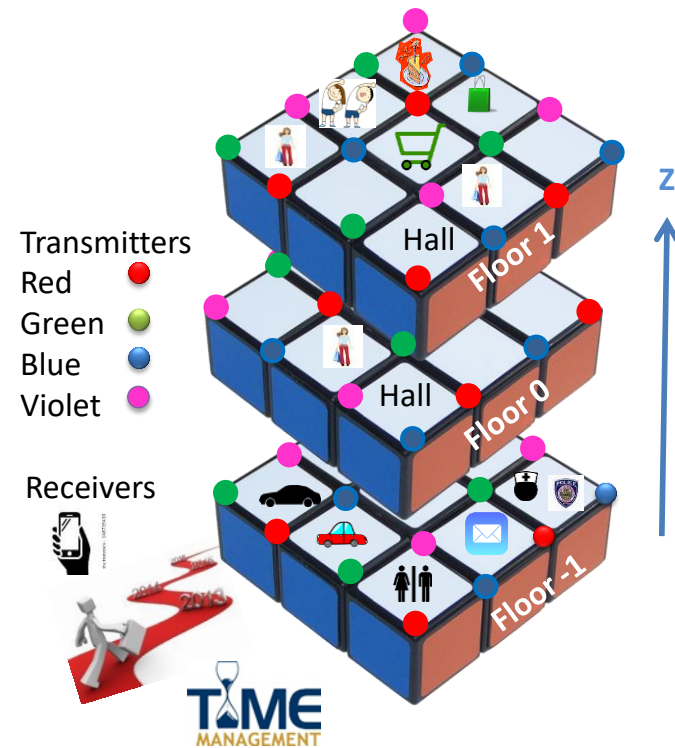

- The system is composed of several transmitters (LEDs ceiling luminaries) which send the map information and path messages required to wayfinding.
- Mobile optical receivers extracts their location to perform positioning and, concomitantly, the transmitted data from each transmitter.
- To synchronize the signals from multiple LEDs, the transmitters use different ID's, such that the signal is constructively at the receiver.
- Bidirectional communication between the emitters and the receivers is available in strategic optical access point (Li-Fi zone).

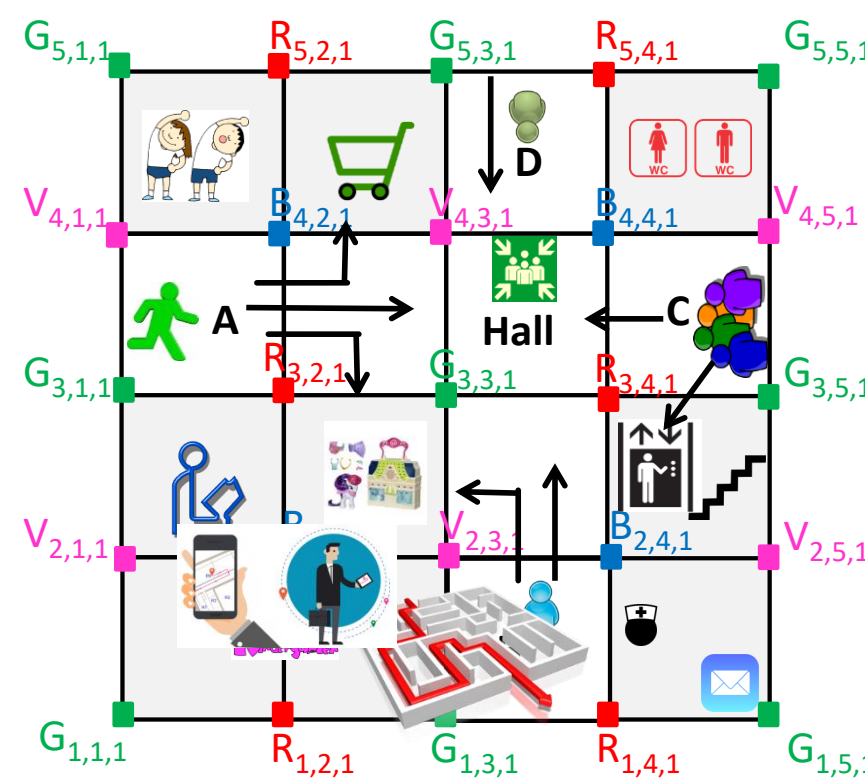
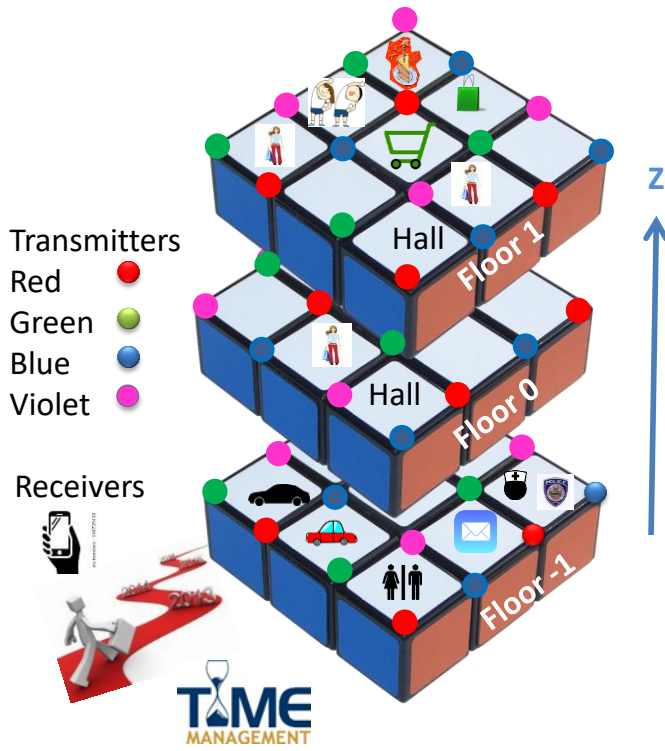

VLC SCENARIO

Shopping center with several floors

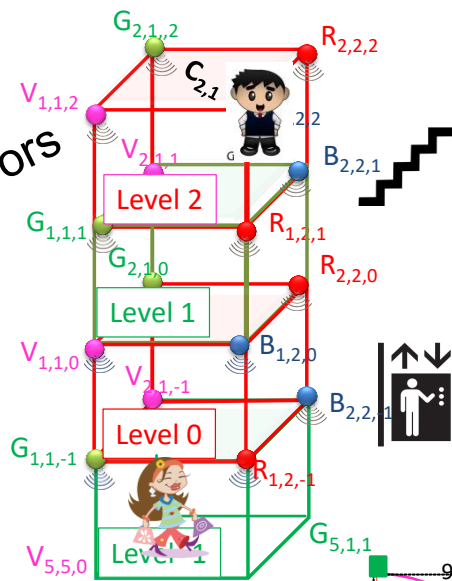

Footprint	Overlap
#1	R+G+B+V
#2	R+G+B
#3	R+B
#4	R+B+V
#5	B+V
#6	G+B+V
#7	G+V
#8	R+G+V
#9	R+G

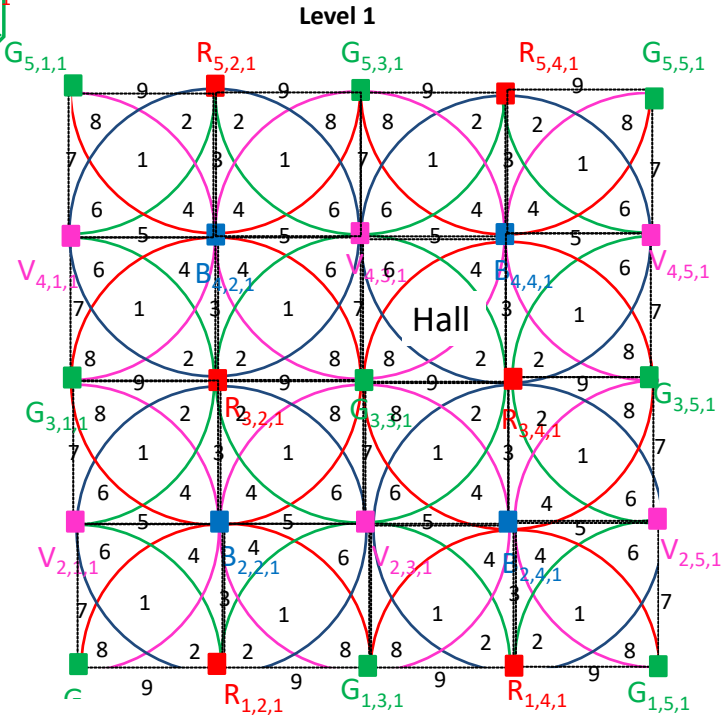
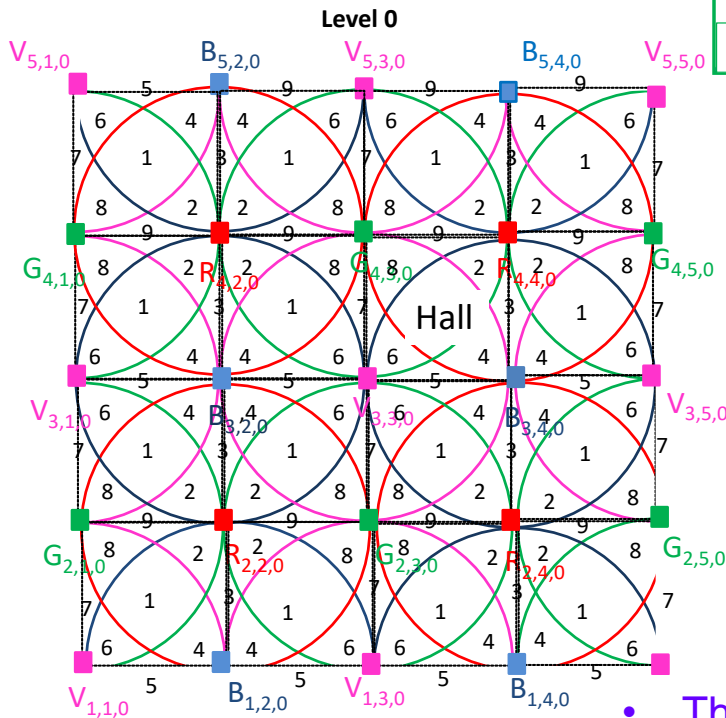

• [The 3D virtual floorplan](#)

- Ceiling plans for the LED array layout in a 3D building, for even and odd floors (R,G,B,V are the modulated color spots for data transmission in each level). The footprint regions assigned to the overlaps are pointed out. 

- An on-off keying modulation scheme was used to code the information. To create a communication protocol and overcome the technology constraints, a 64 bits data frame was designed.

Original encoded message, in a time slot:

Transmitted node packet from the unit cell $C_{4,3,0}$ in the network. $R_{4,4,0}$; $G_{4,3,0}$; $B_{3,4,0}$ and $V_{3,3,0}$

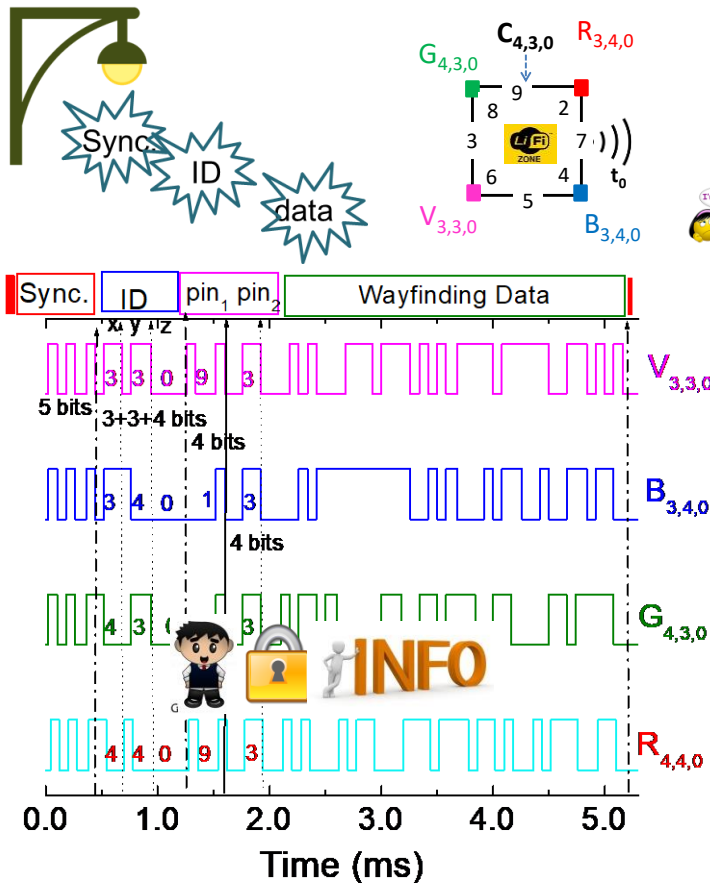

Transmitted node packet from the CM at the unit cell $C_{2,3,1}$. $R_{1,4,-1}$; $G_{1,3,-1}$; $B_{2,4,-1}$ and $V_{2,3,-1}$

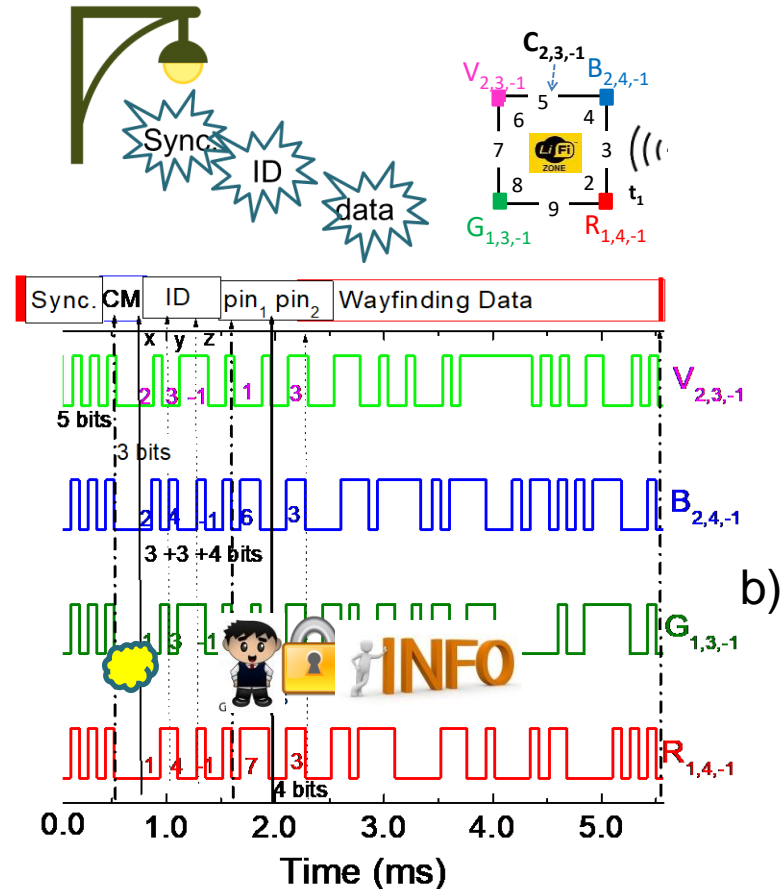

MUX-DEMUX

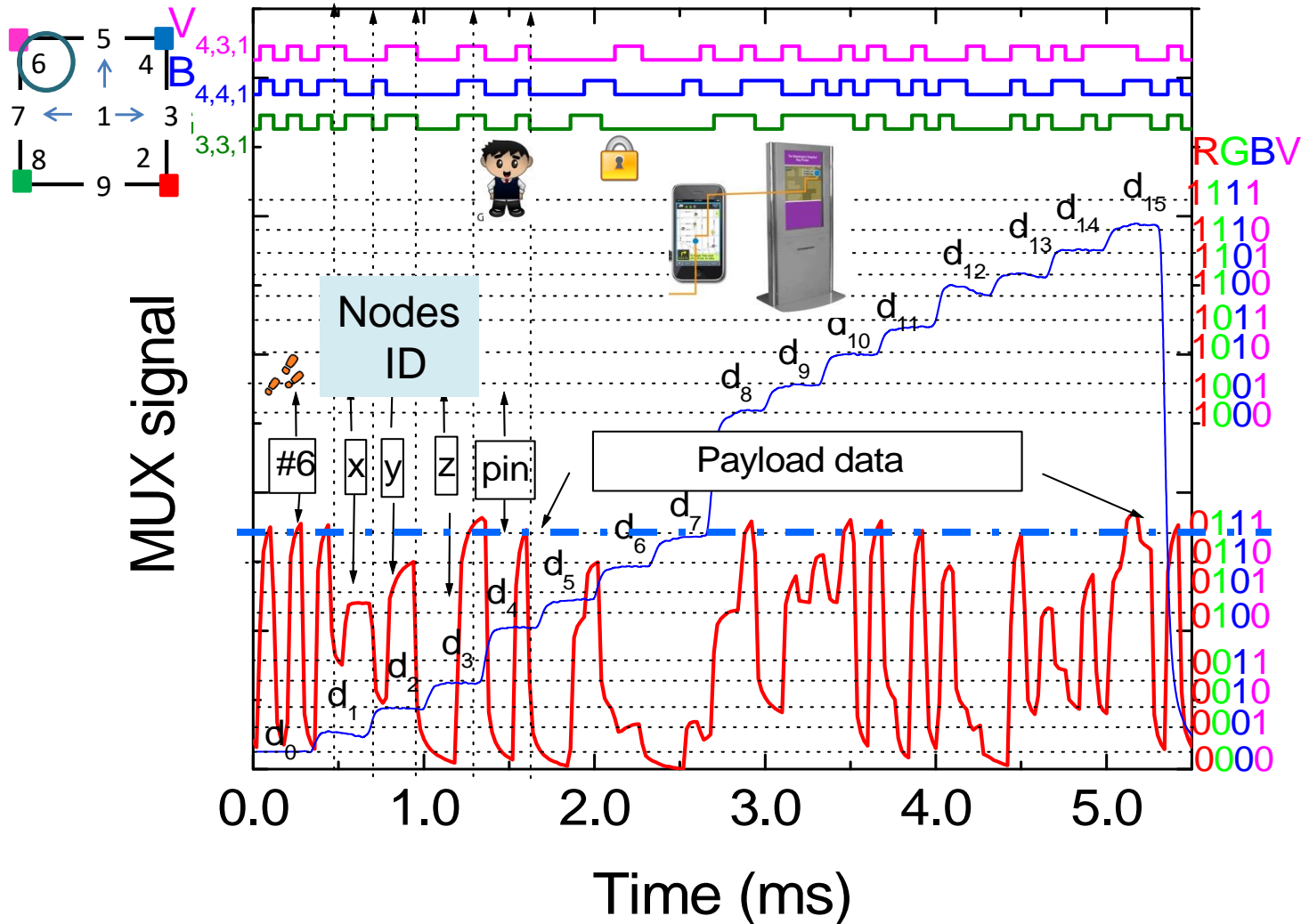

- The footprint position comes directly from the synchronism block, where all the received channels are, simultaneously, *on* or *off*.
- The next block of ten bits gives the ID of the received nodes.
- The last block is reserved for the transmission of the wayfinding message.

NAVIGATION DATA BITS

I_{MUX}^{nor}

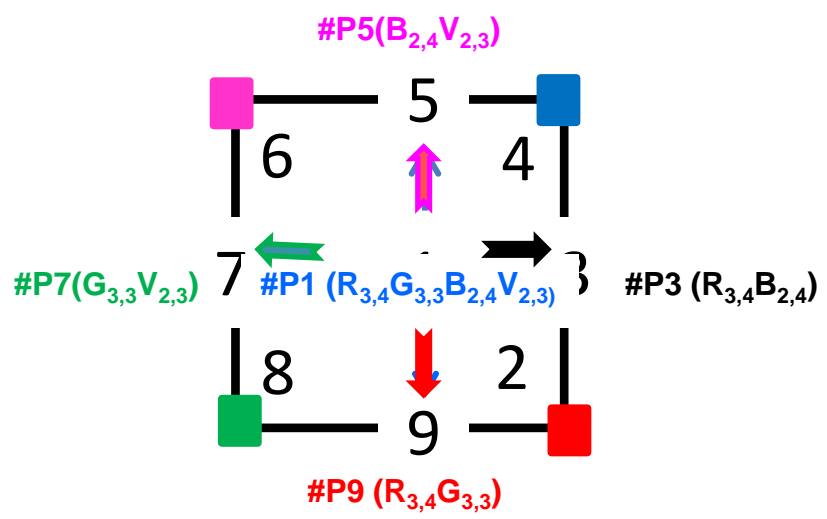
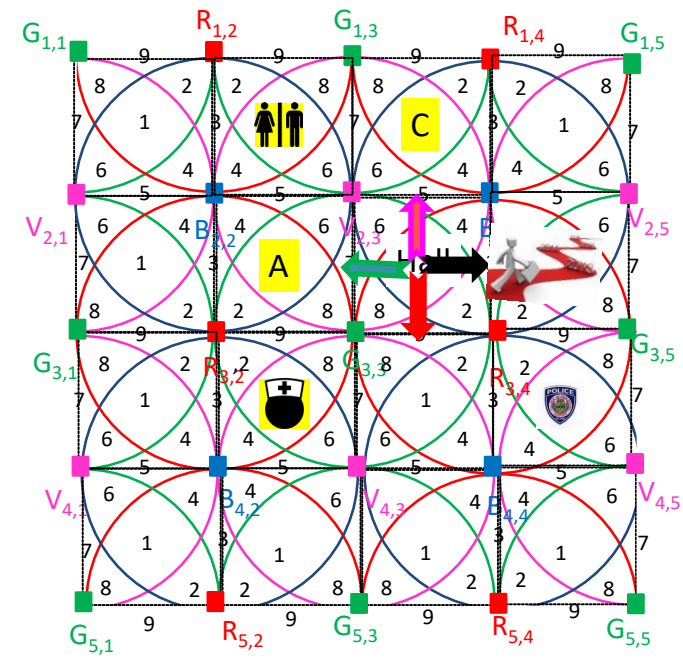
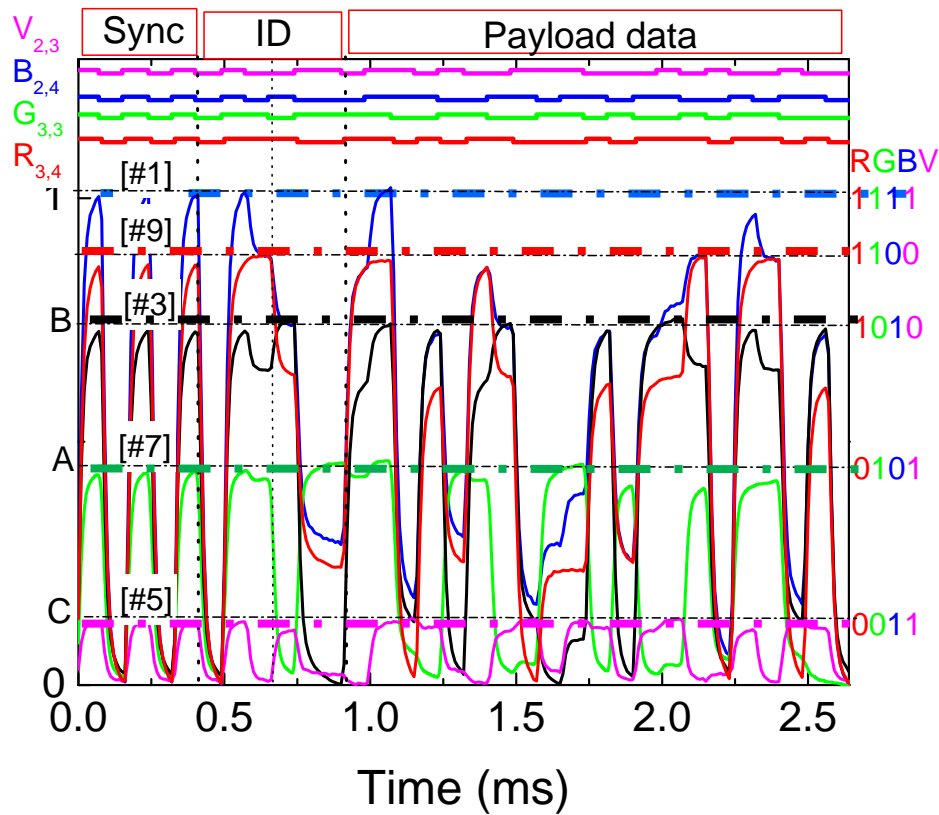

- To compute the point-to-point along a path, we need the data along the path.
- As the receiver moves between generated point regions, the received information pattern changes. The transition actions are correlated by calculating the ID position codes in successive instants.

Aided dynamic navigation

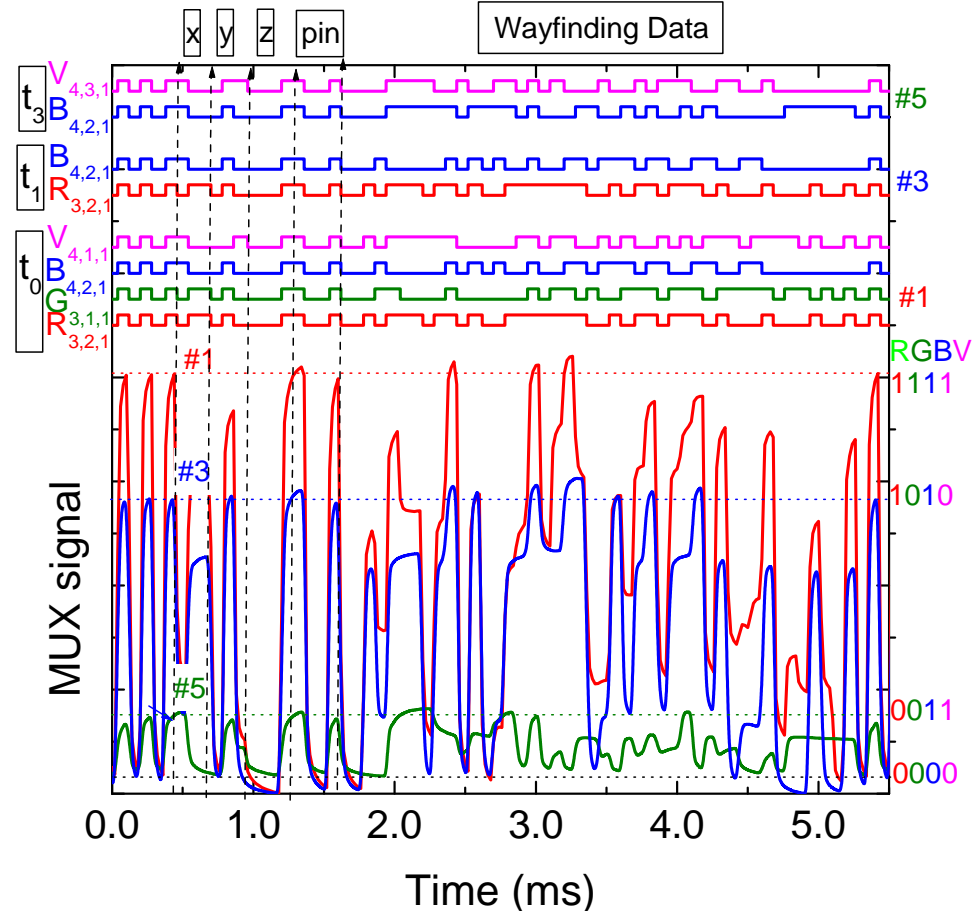
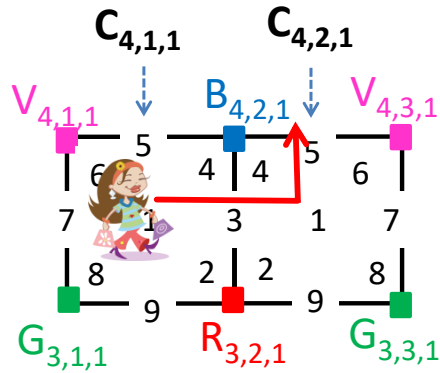

Fine-grained indoor localization and navigation in successive instants. On the top the received channels packets are decoded at each time step [R, G, B, V].

- The user enters the floor 1 by line #7 ($C_{4,1,1}$), it goes to position #1(t_0) being directed by the CM into the pretended directions ($C_{4,2,1}$ # 5) where she arrives at t_3 passing through footprints #3 (t_1) and #1(t_2) from the next cell.

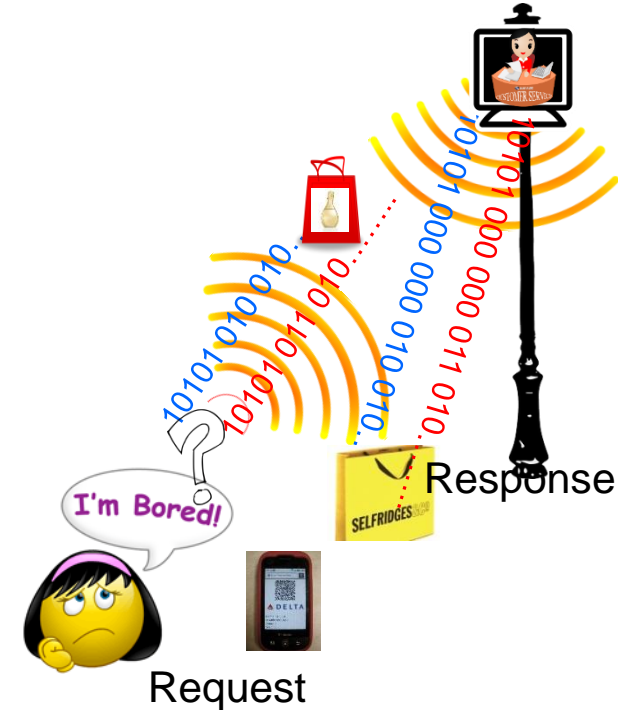
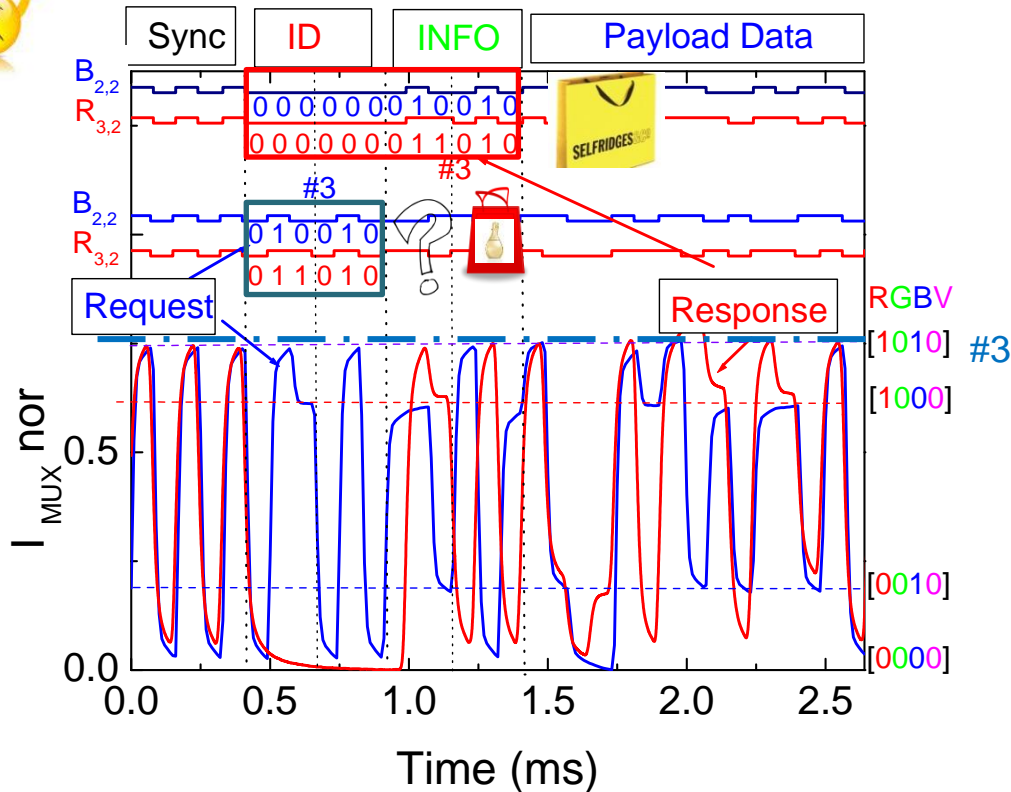

- Bi-directional communication between VLC emitters and receivers at a handheld device can be established through a control manager linked to an indoor billboard.
- Using a white polychromatic LED as transmitter, the receptor sends to the local controller a “request” message with its location (ID) and adds its needs for the available time. For route coordination, the local controller emitter sends the “response” message.
- Each ceiling lamp broadcasts a message with its ID and advertising which is received and processed by the receiver.

The user sends to the CM a “request” message with his location (x,y,z), identification (pin₁) and also adds its needs (Wayfinding data). If a meeting between users is requested they need previously to combine a common code and insert it in the “request” (pin₂).



Route Coordination

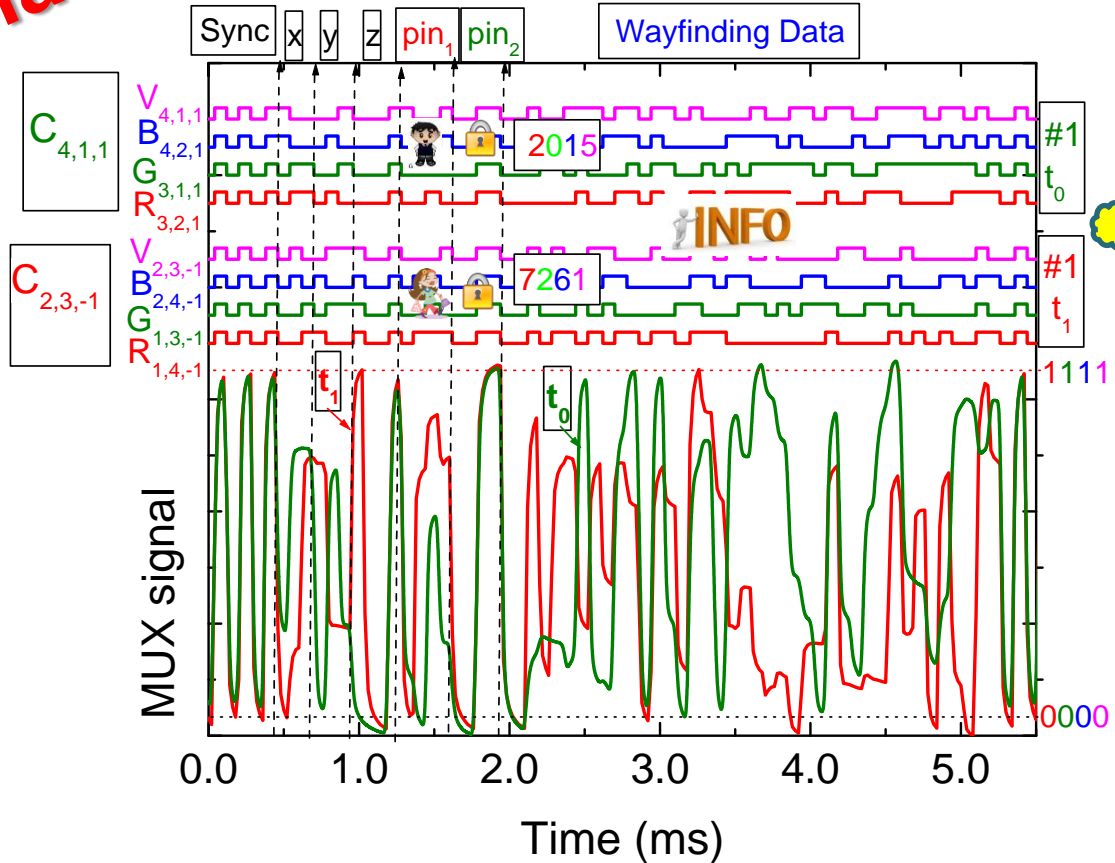
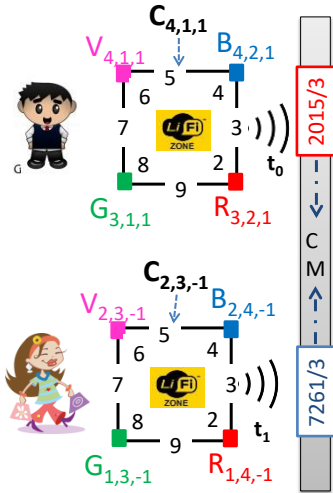

MUX synchronized signals from two identify users

Signal received by the CM receiver from two users (“2015” and “7261”) at different locations (C_{4,1,1}; #1 and C_{2,3,-1}; #1) in successive instants (t₀ and t₁). On the top the transmitted channels packets are decoded [X_{i,j}].

Responses sent by the CM to user “7261” the moment she arrives for the scheduled meeting (t_1) and when she is in the vicinity of the chosen location (t_2).

Buddy wayfinding

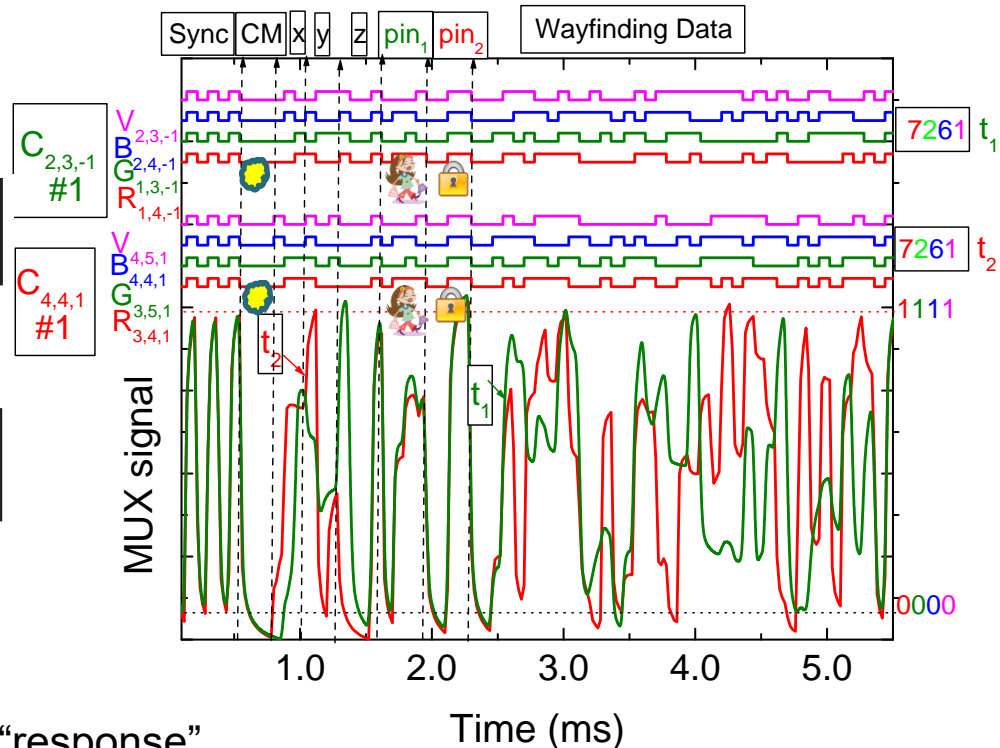
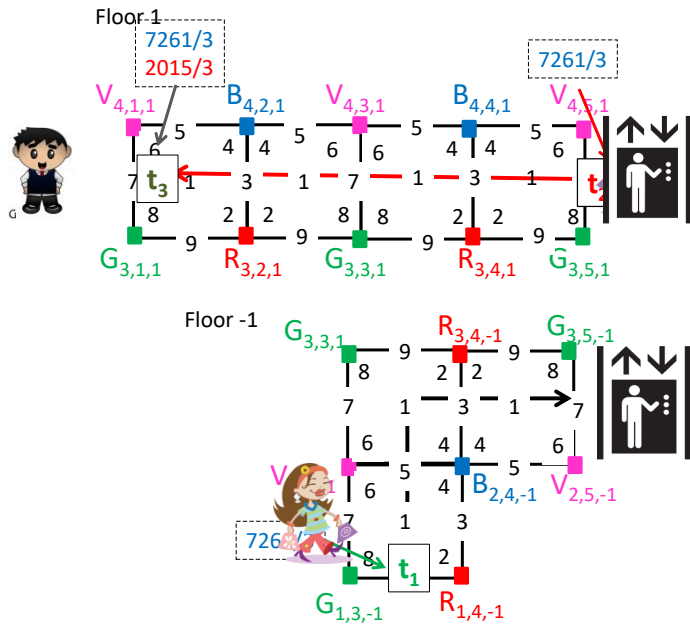

MUX/DEMUX signals assigned to a “response”.

The emitter controller [000] responds to the successive requests (t_1 , t_2) of an user (“7261”) that has required the shortest path to have a meeting (pin₂/3) with a friend (“2015”) that was shopping in the same center when she arrives ($C_{2,3,-1}$; t_1) and has asked for buddy wayfinding services before (t_0), from cell ($C_{4,4,1}$).

- A generating method of ceiling landmark route instructions using VLC was proposed.
- For lighting, data transmission and positioning, white LEDs were used. A SiC optical MUX/DEMUX mobile receiver decodes the data and infers its path location, timing and user flows.
- A 3D building model for large indoor environments was presented, and a VLC scenario in a three-level building was established. The communication protocol was presented. Bi-directional communication was analyzed.
- Global results show that the location of a mobile receiver, concomitant with data transmission is achieved. The dynamic LED-aided VLC navigation system enables to determine the position of a mobile target inside the network, to infer the travel direction along the time and to interact with received information.
- The VLC system can help to find the shortest path to a place, guiding the users on a direct, shortest path to their destinations.
- Research is still necessary to optimize the coverage; effects as synchronization, shadowing and ambient light could be minimized through MIMO techniques.



CONCLUSIONS



Bidirectional communication in an automated warehouse

- ✓ Use of autonomous vehicles to grab goods and carry them to the packaging station
- ✓ Navigation along pre-defined routes
- ✓ COOPERATIVE APPROACH: bidirectional communication



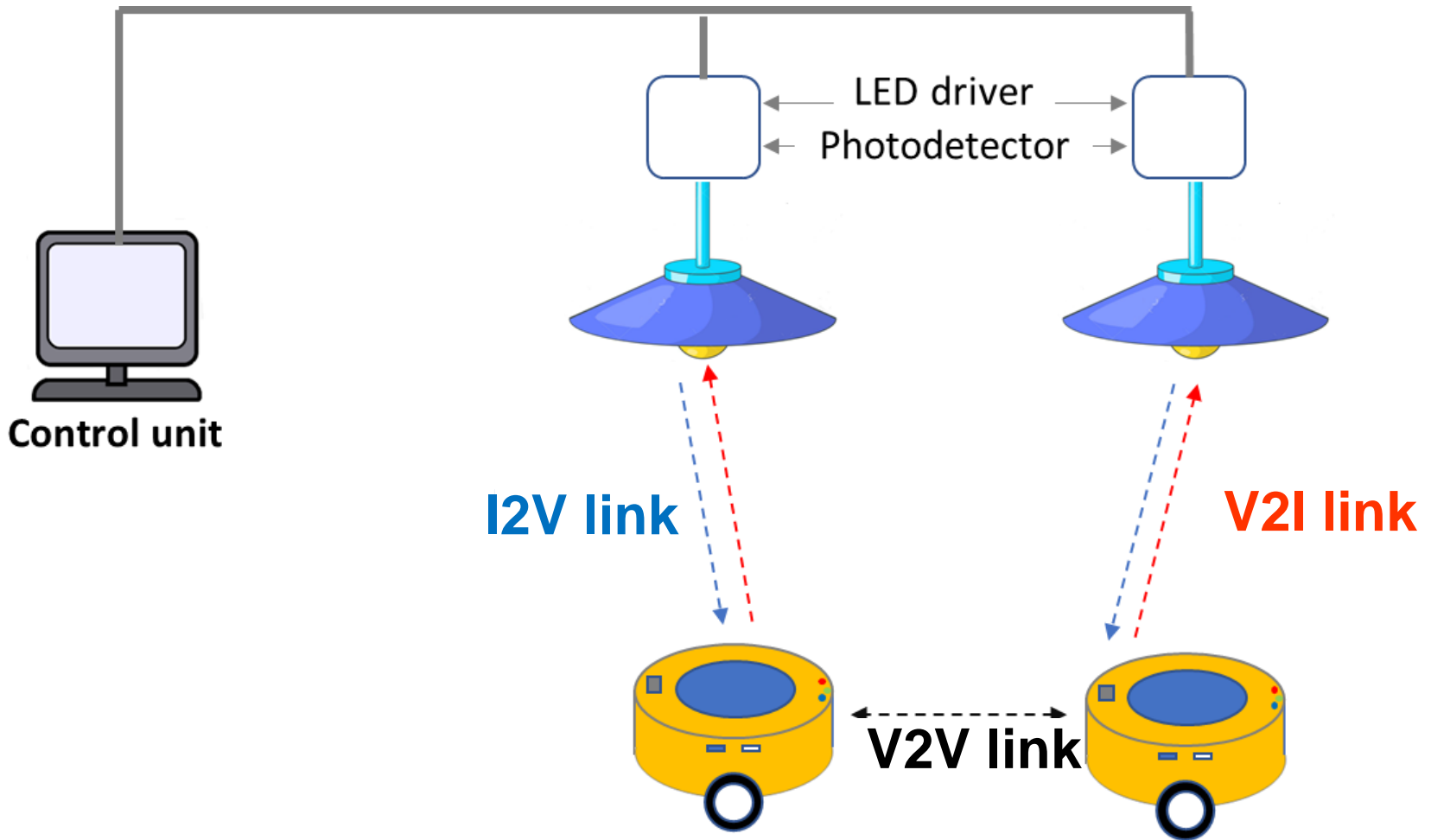

- I2V lamps to autonomous robots
- V2I: robots to lamps
- V2V: robots to robots

White RGB LEDs

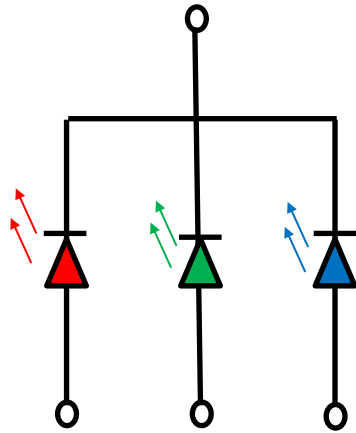
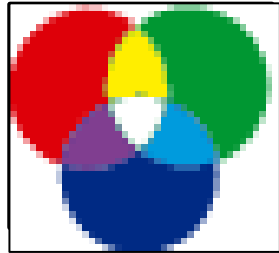

11011101

11011101

11011101

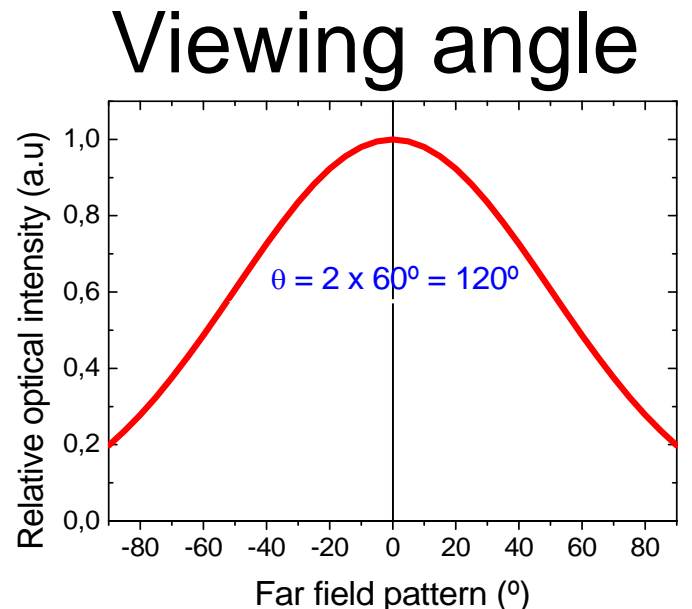
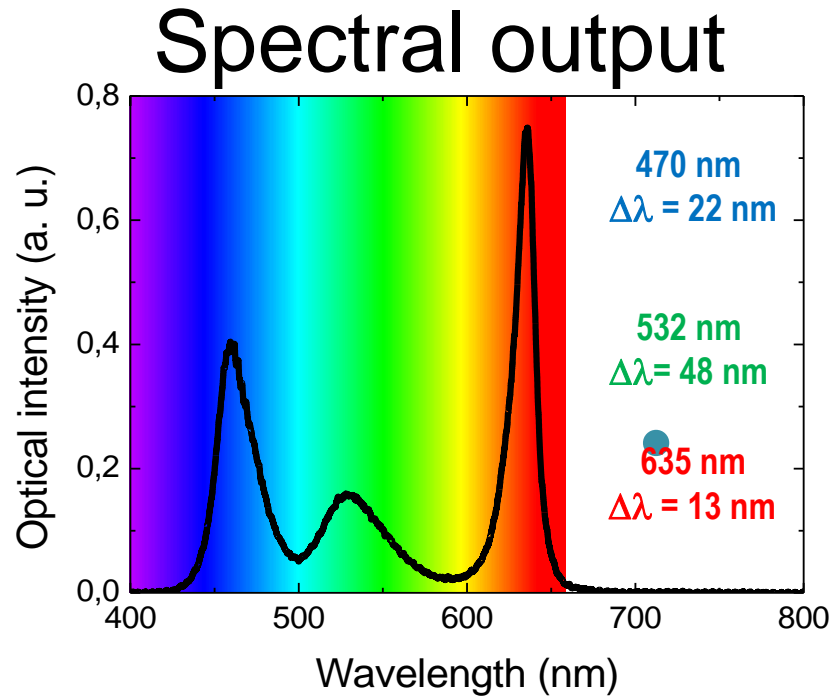

RECEIVER

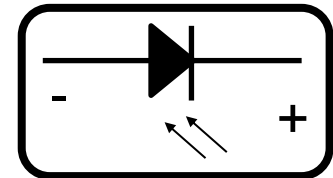
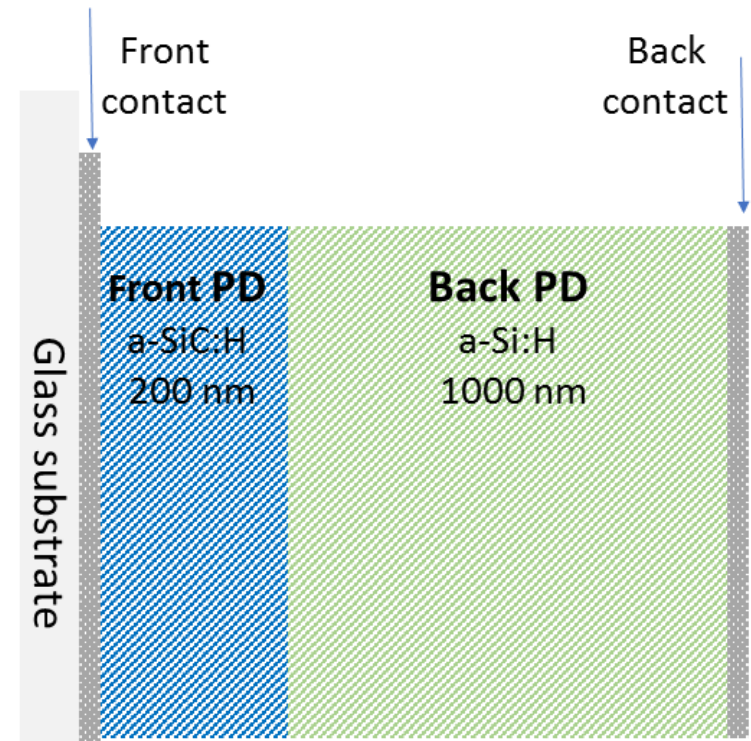
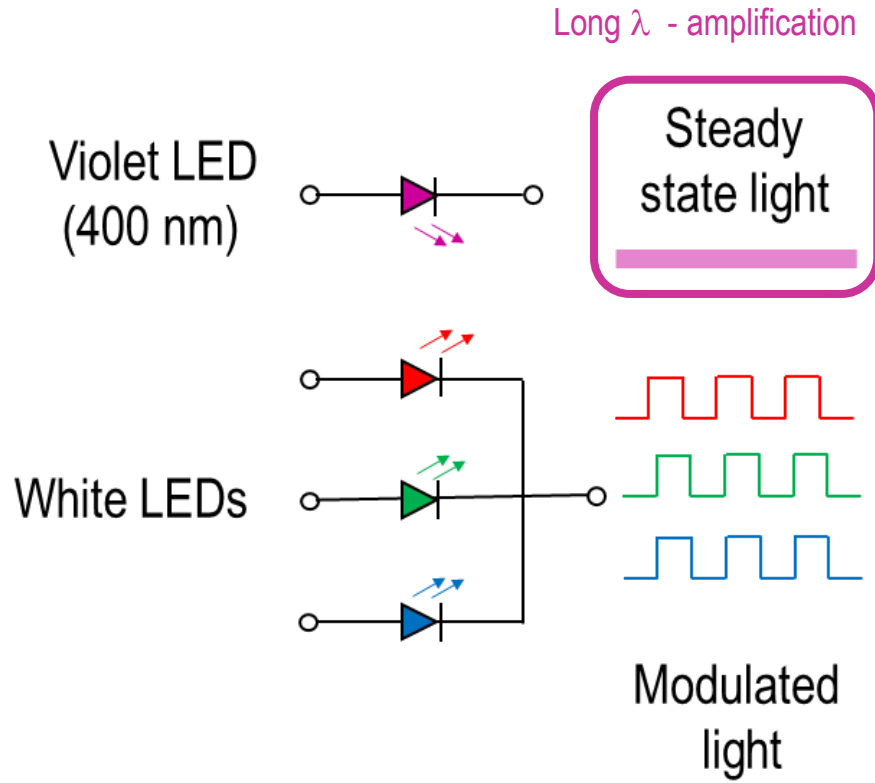

POSITIONING & NAVIGATION

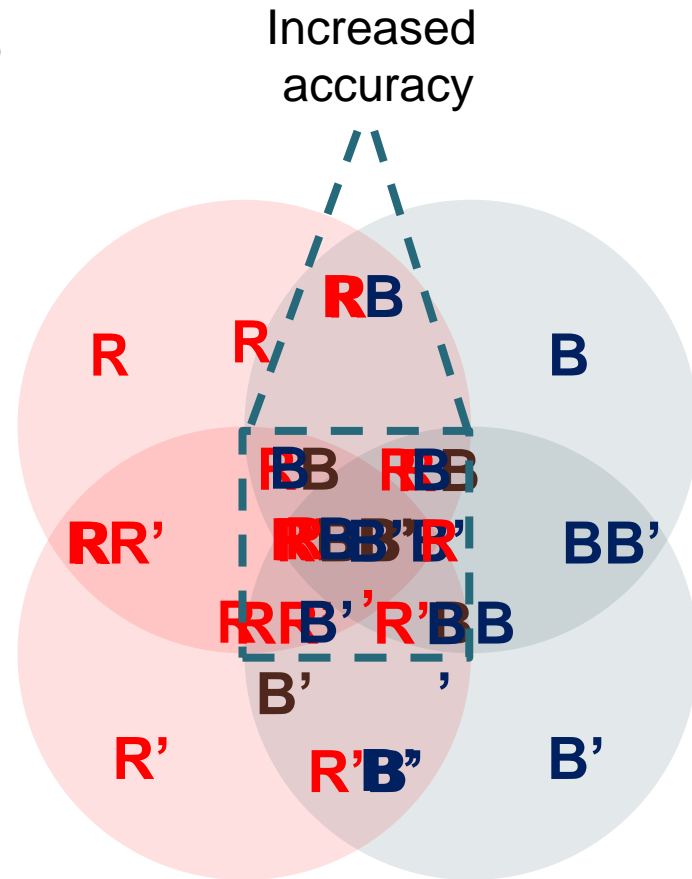
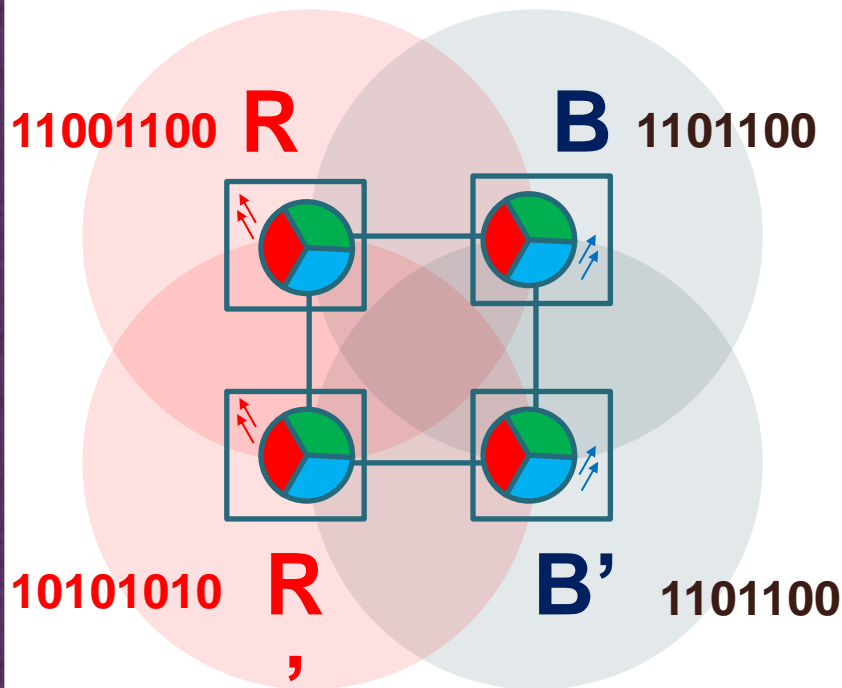
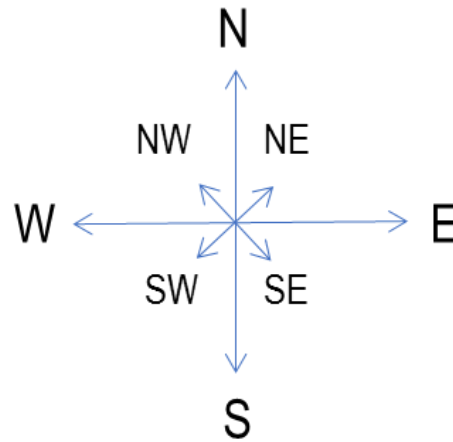

NAVIGATION CELLS

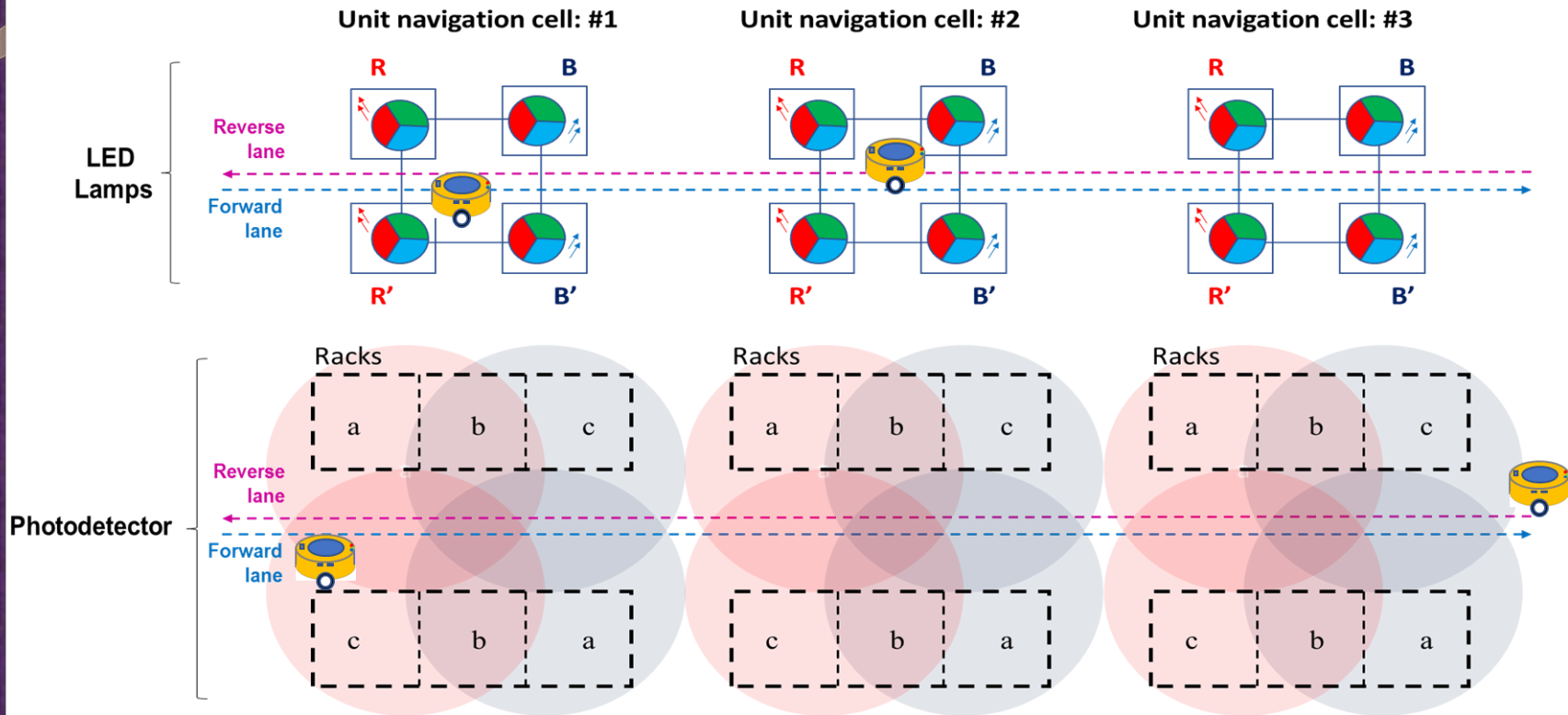

I2V CHANNEL

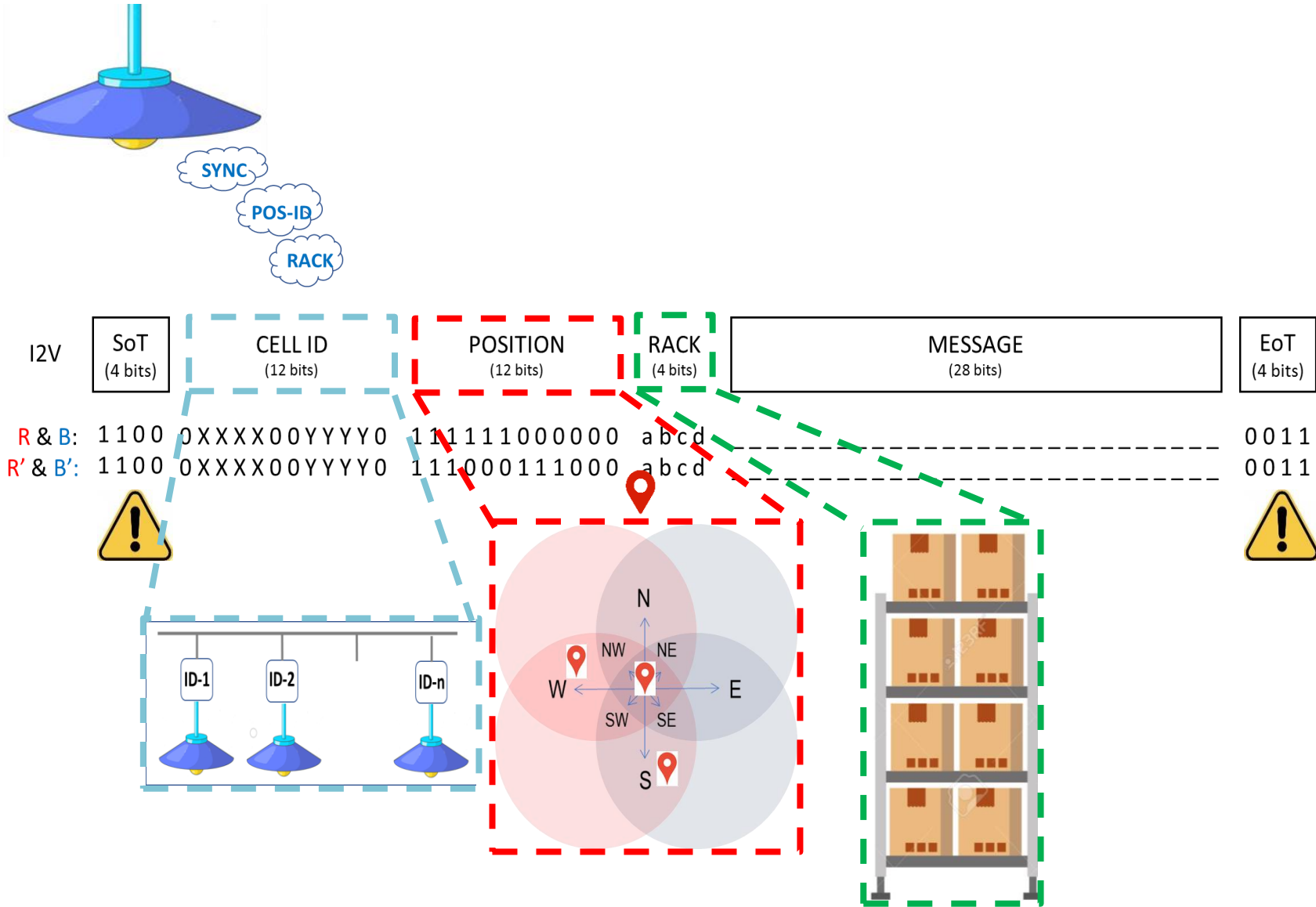

ON-OFF Keying Modulation

I2V CHANNEL

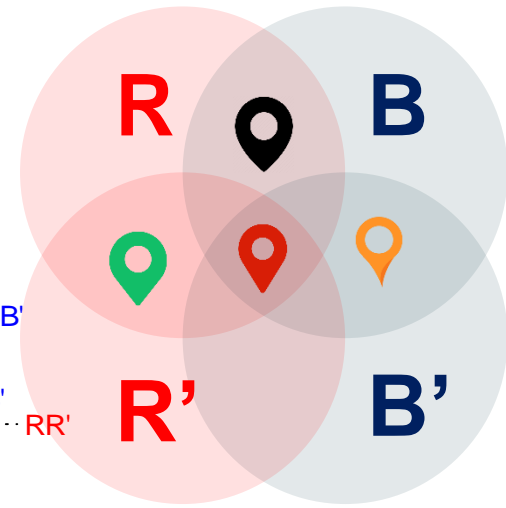
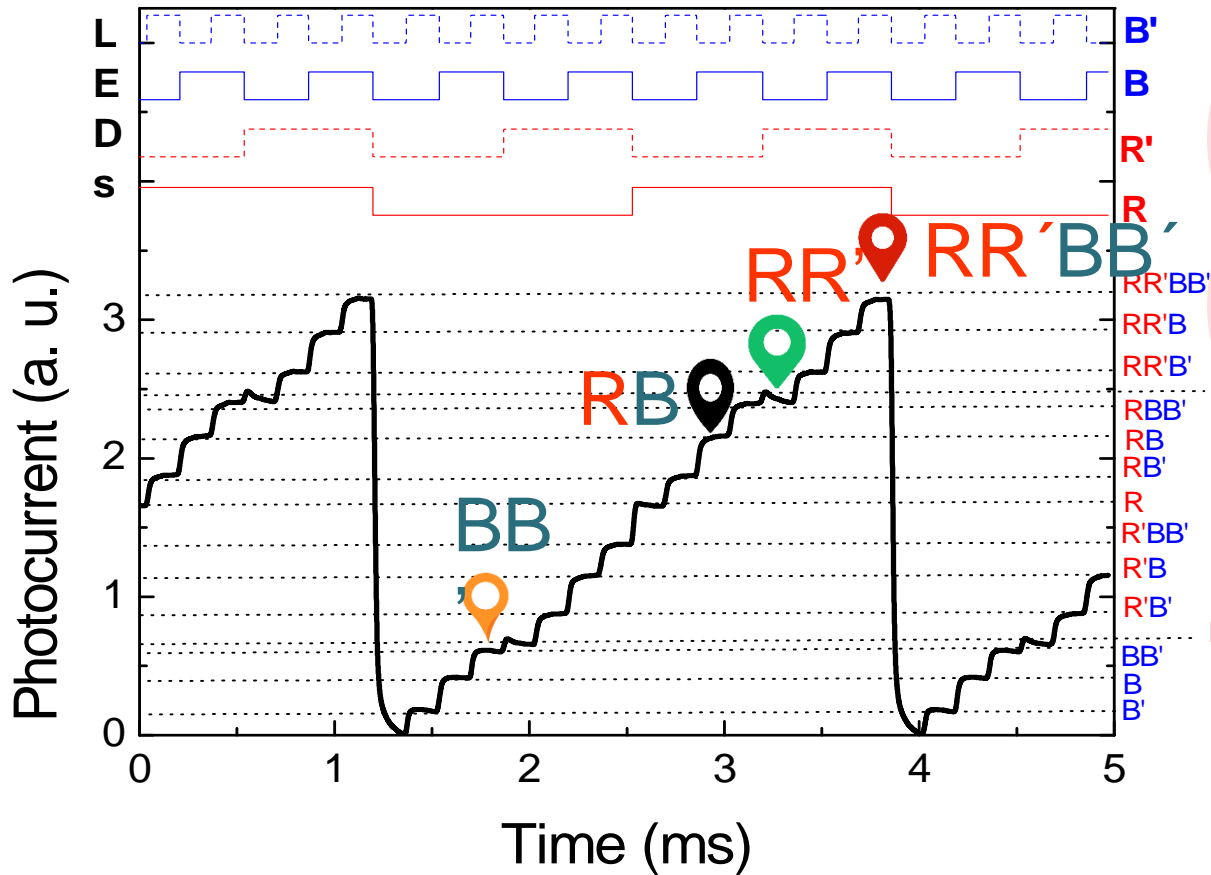

- Simultaneous modulation of **4** emitters
- The resultant optical signal is a combination of 4, 3, 2 or 1 optical signals → **16** possible photocurrent levels
(The driving current of each LED emitter was adjusted to provide different levels of photo excitation)

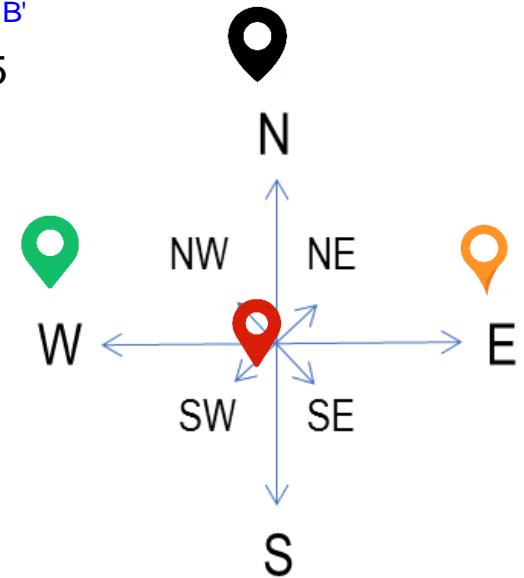

I2V CHANNEL

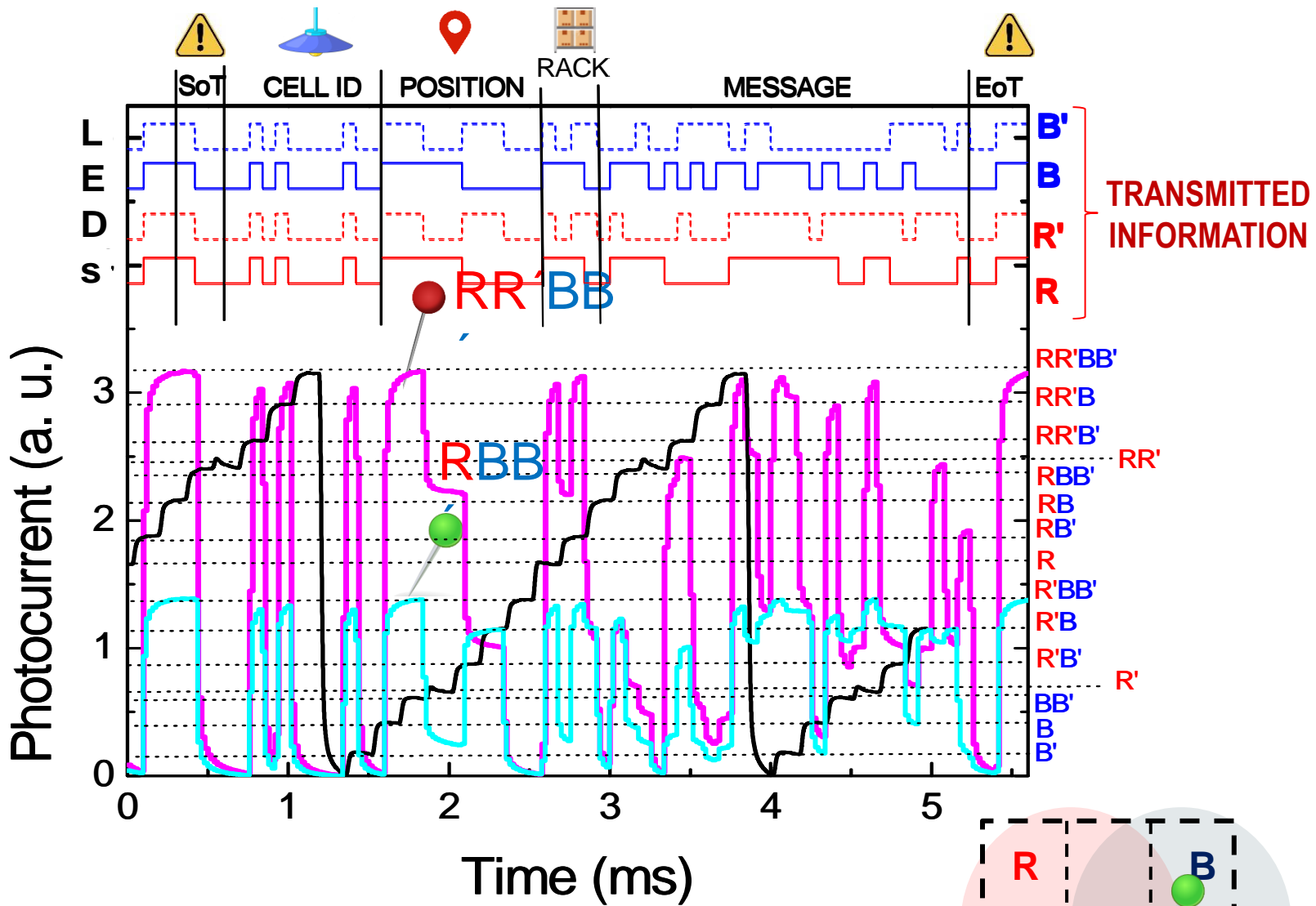

CELL ID: 001010000100
 Line: 0101₂ (5₁₀)
 Column: 0010₂ (2₁₀)

Top emitters: 111 0
 Bottom emitters: 101 1

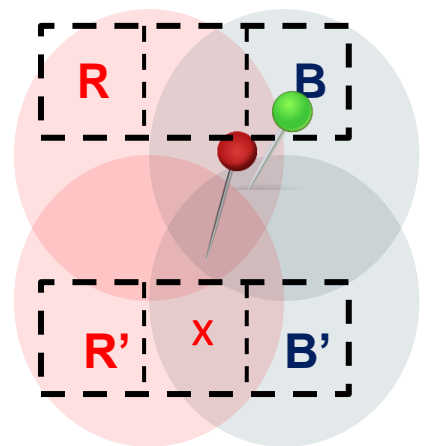

PARITY CHECK BITS

$$P1 = R + R' + B'$$

$$P2 = R' + B + B'$$

$$P3 = R + B + B'$$

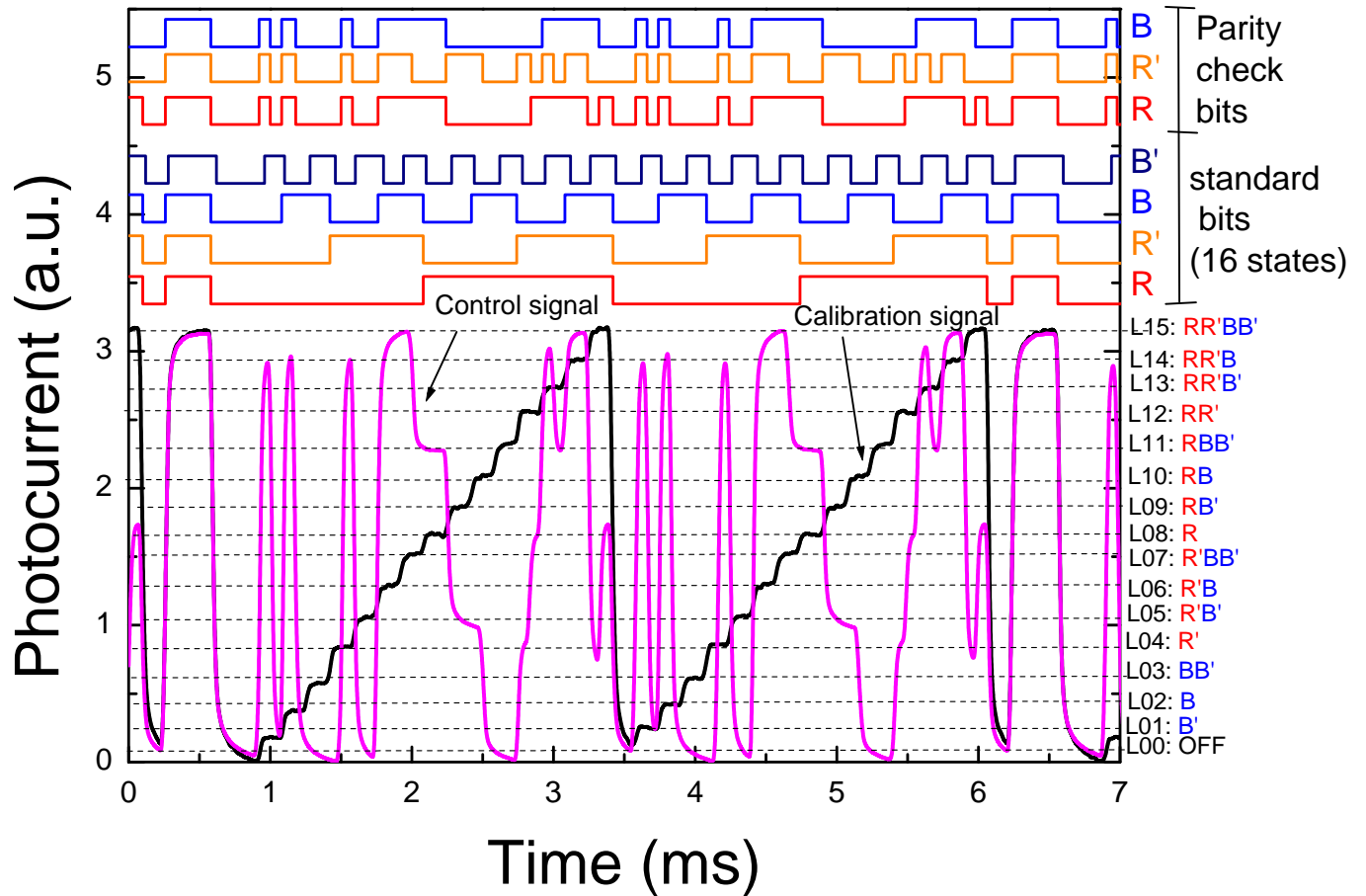
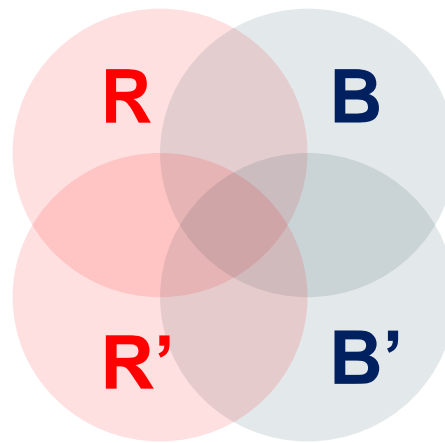

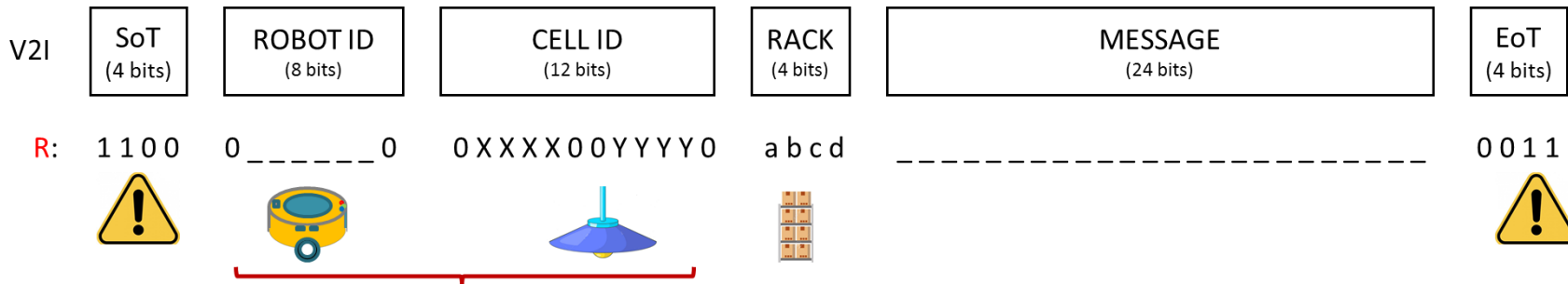

ID of both partners

- ROBOT ID: $01100110_{|_2}$ ($118_{|_{10}}$)
- CELL ID: $1100_{|_2}$ ($5_{|_{10}}$) & $0010_{|_2}$ ($2_{|_{10}}$)
- RACK: items from rack a and c located at the south direction (forward lane) were removed

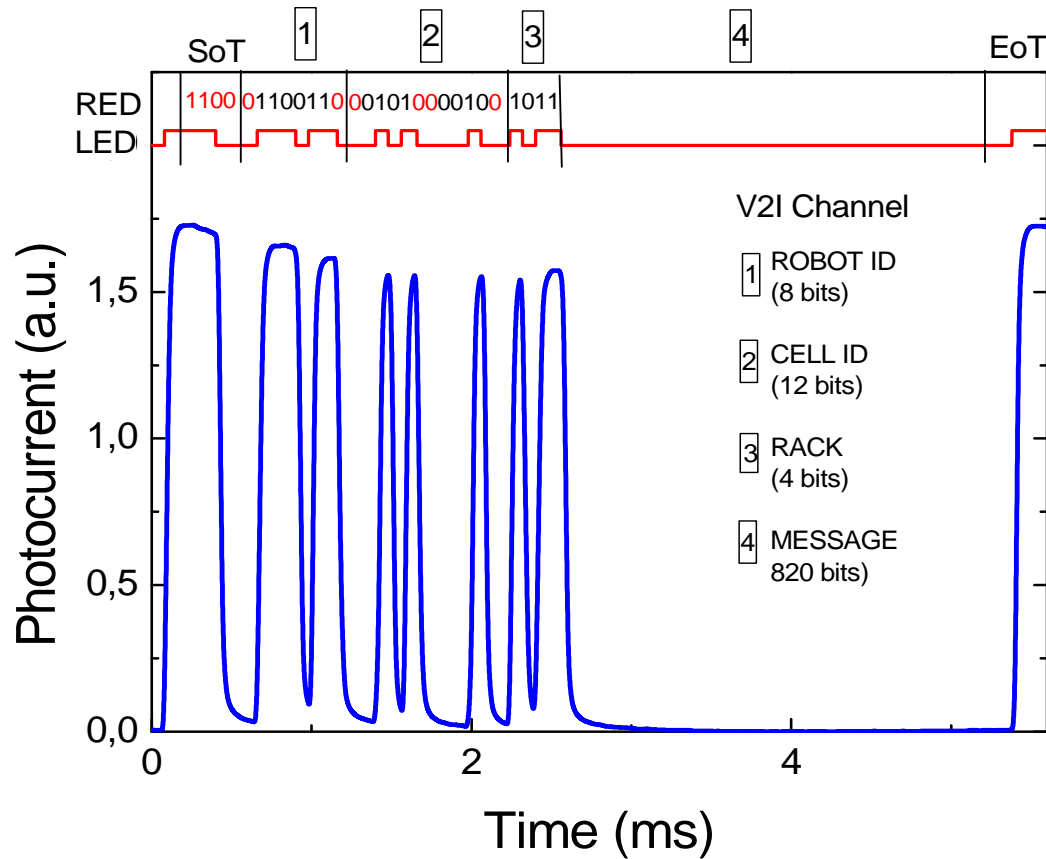
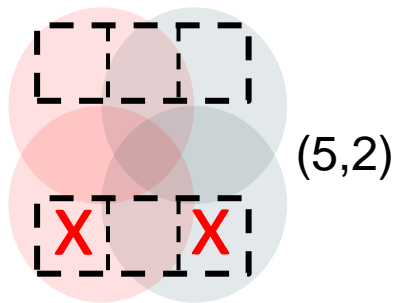

- ✓ Bi-directional communication using VLC has been addressed in a robot navigation system inside a warehouse.
- ✓ Different links were proposed to establish I2V and V2I communication.
- ✓ Definition of specific codes for each link using 64 bits word. ON-OFF Keying modulation.
- ✓ I2V link – positioning and navigation information using 4 emitters.
- ✓ V2V link - data transmission using a single emitter.
- ✓ Flickering effects were addressed by suitable control of the amount of transitions to zero.
- ✓ Implementation of bit error control schemes.
- ✓ **Future work**
 - ✓ Analysis of the system under other background illumination sources (noise, photodiode saturation...).

OUTDOOR APPLICATION



VEHICLE-TO-EVERYTHING (V2X)

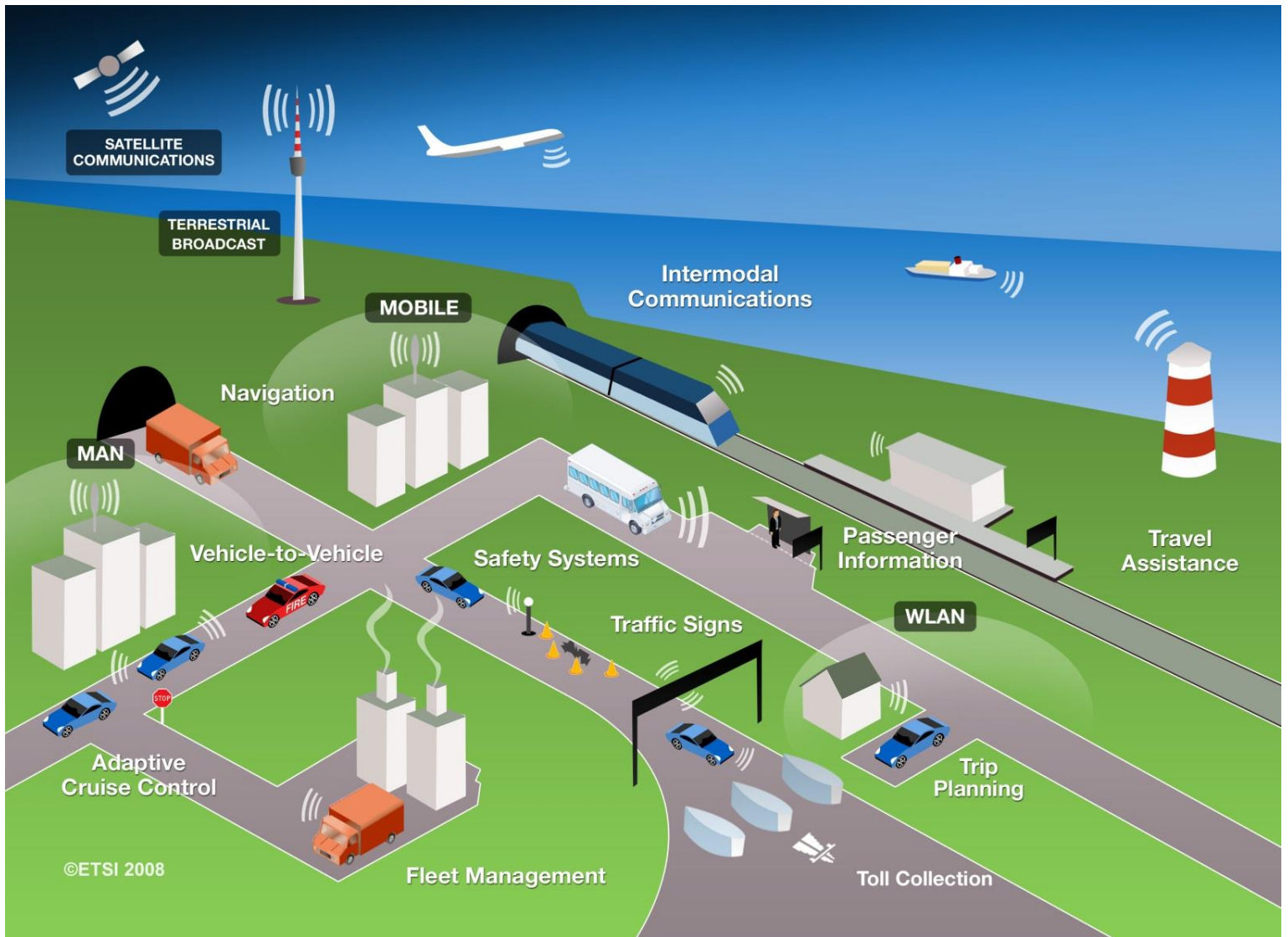

VISIBLE VEHICULAR
COMMUNICATION



Vehicle-to-everything (V2X)

- VLC seems to be appropriate for providing wireless data exchange for automotive applications.
- Visible light represents a new communication opportunity for vehicular networking applications.
- The communication is performed through VLC using the street lamps and the traffic signaling to broadcast the information.



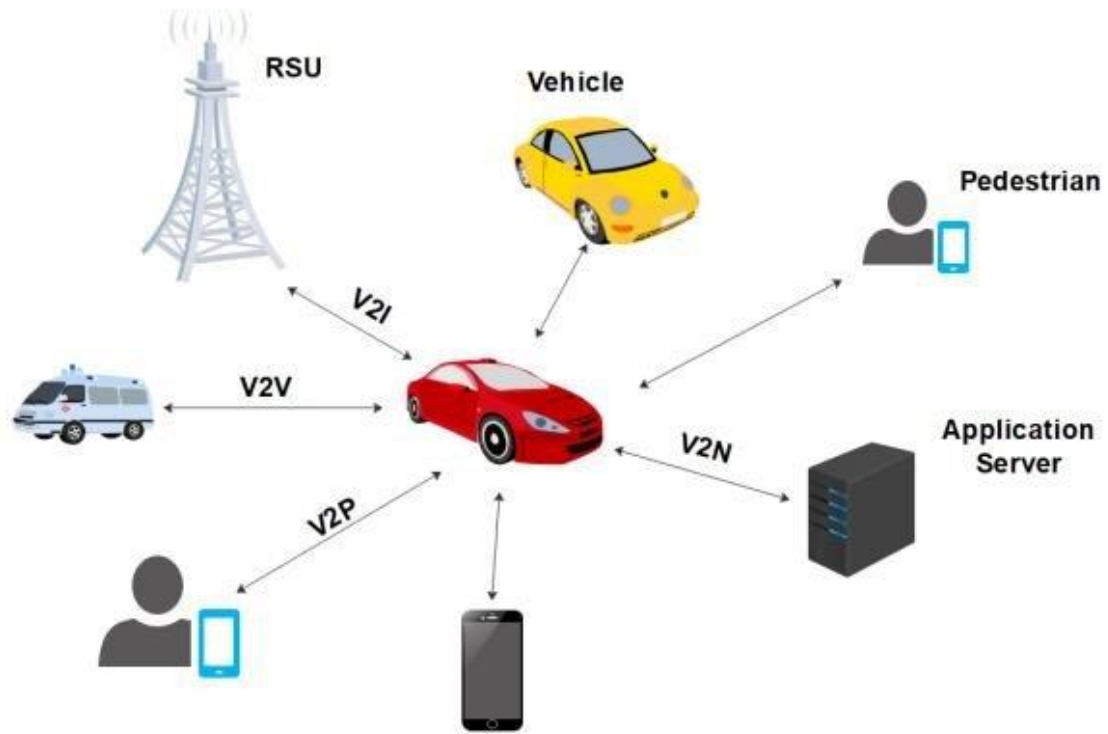

- Vehicular Communication Systems are a type of network in which vehicles and roadside units are the communicating nodes, providing each other with information, such as safety warnings and traffic information.
- Communication between fixed locations and vehicles (Infrastructure-to-Vehicle, I2V) between vehicles (Vehicle-to-Vehicle, V2V), and between vehicles and fixed locations (Vehicle-to-Infrastructure, V2I) is essential to transfer information in real time.
- The I2V applications focus on utilizing the traffic related infrastructure, such as traffic light or streetlight to communicate useful information.

- In this work, a two-way communication between vehicles and the traffic lights is implemented. The redesign of the trajectory is presented.
- Street lamps and traffic lights broadcast the information.
- The On-vehicle VLC receivers decode the messages and perform V2V distance measurements.
-
- A V2X traffic scenario is proposed and characterized. A phasing traffic flow is developed as a Proof-of-Concept (PoC).
-
- The simulated results confirm that the redesign of the intersection and its management through the cooperative request/response VLC architecture allows to increase the safety and to decrease the trip delay.

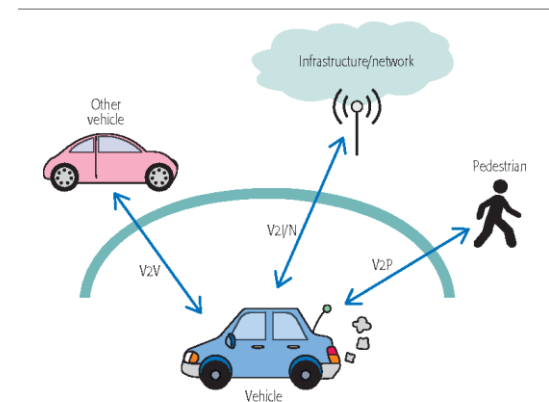

The proposed system is composed of several transmitters, the street lights and the traffic signals, which transmit map information and traffic messages required to the moving vehicles.



Data is encoded, modulated and converted into light signals emitted by the transmitters. Then, this information is transferred to receivers installed in the vehicles.

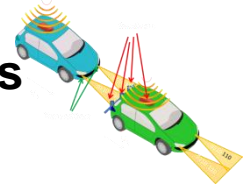

Every street light has their differentiable Identifications (IDs) for the generation of the visible light signal that transmits the map information through a Visible Light Transmitter module.

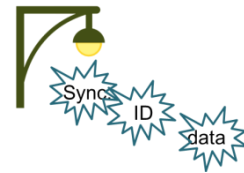

Tetra-chromatic white sources are used providing a different data channel for each chip. Every vehicle is equipped with a receiver module for receiving the mapped information generated from the street.

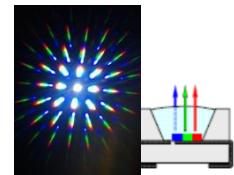

The receiver modules include a photodetector based on a tandem a-SiC:H/a-Si:H pin/pin light controlled filter that multi the different optical channels, perform different filtering processes (amplification, switching, and wavelength converters and decode the encoded signals, recovering the transmitted information.

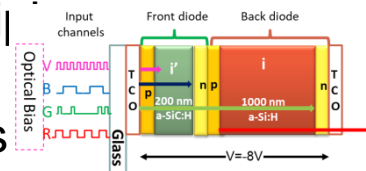

Generic model

cooperative vehicular and vulnerable road users communications

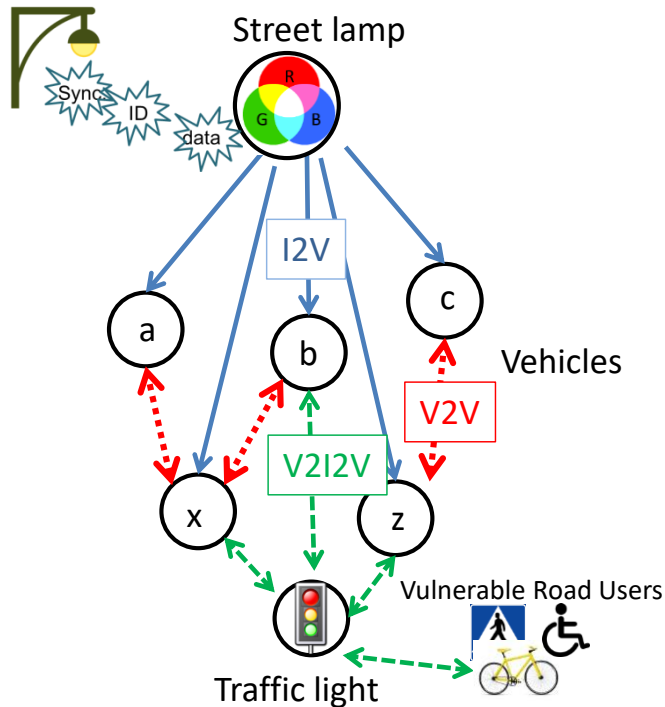

Until recently...

- (V2V) communication was limited to brake lights, turn signals;
- (V2I) was restricted to point detection (loop detectors).

Illustration of the proposed V2X communication scenario:

✓ Connected vehicles communication in a crossroad.

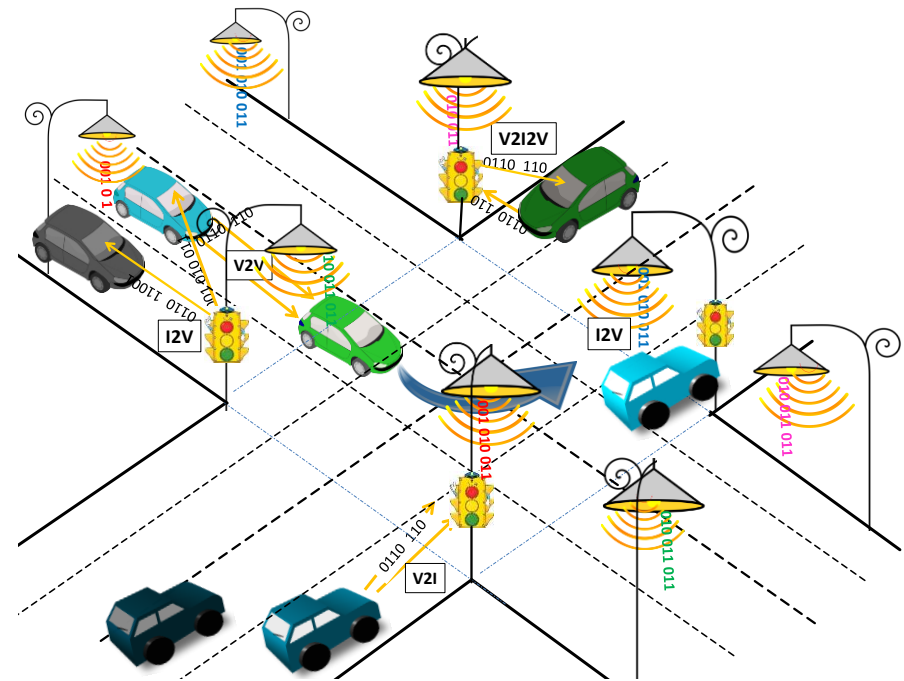

The IoT network



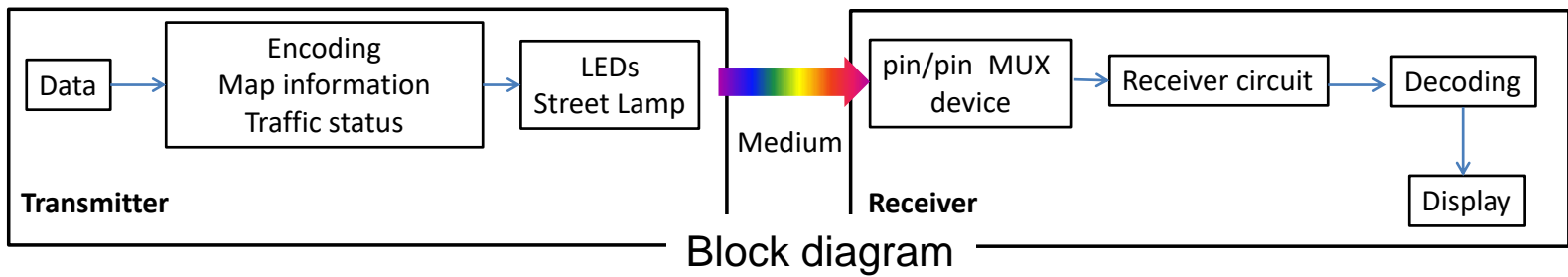

- Using the I2V communication, each street lamp (transmitter) sends a message, which is received and processed by a SiC receiver, located at the vehicle's rooftop.

- Using the headlights as transmitters, the information is resent to a leader vehicle (V2V) or, depending on the predefined occupied lane, a "request" message to go forward or turn right (right lane) or to turn left (left lane) is sent directly to a crossroad receiver (V2I), at the traffic light, interconnected to a local manager that feeds one or more signal heads.

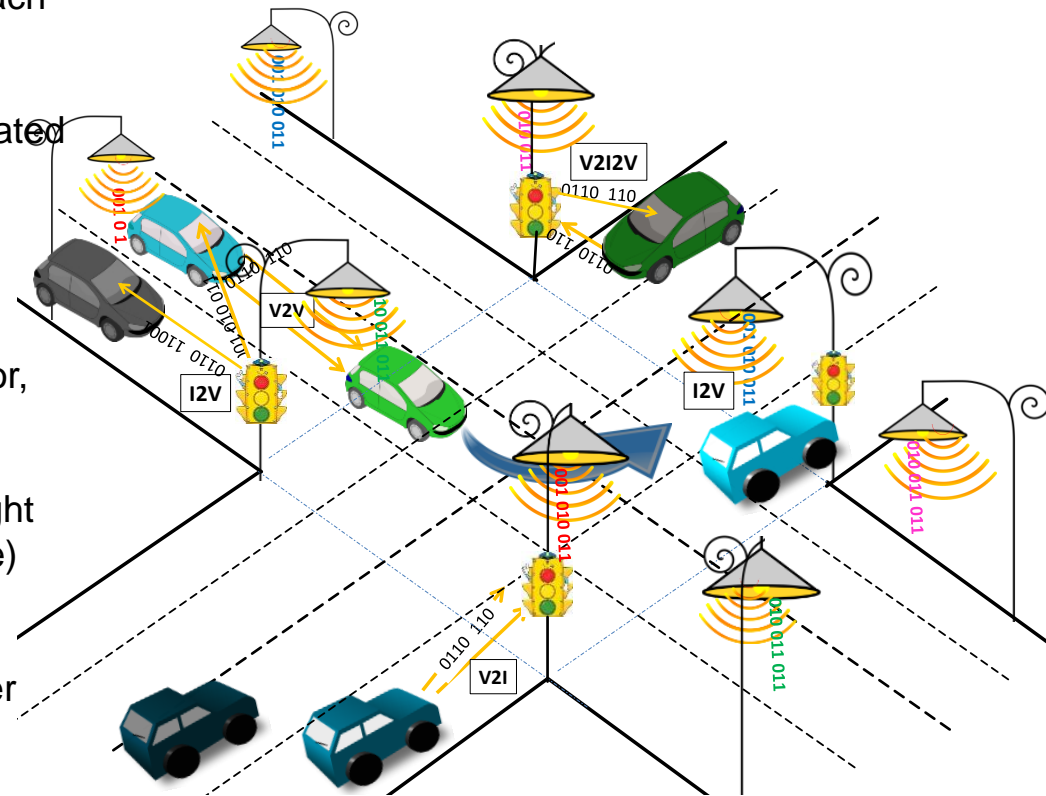

- For crossroad coordination, a local controller emitter located at the light signal, send a "response" message to the vehicles approaching the intersection (I2V). Bidirectional communication is then established (V2I2V).

Generalized view of the architecture

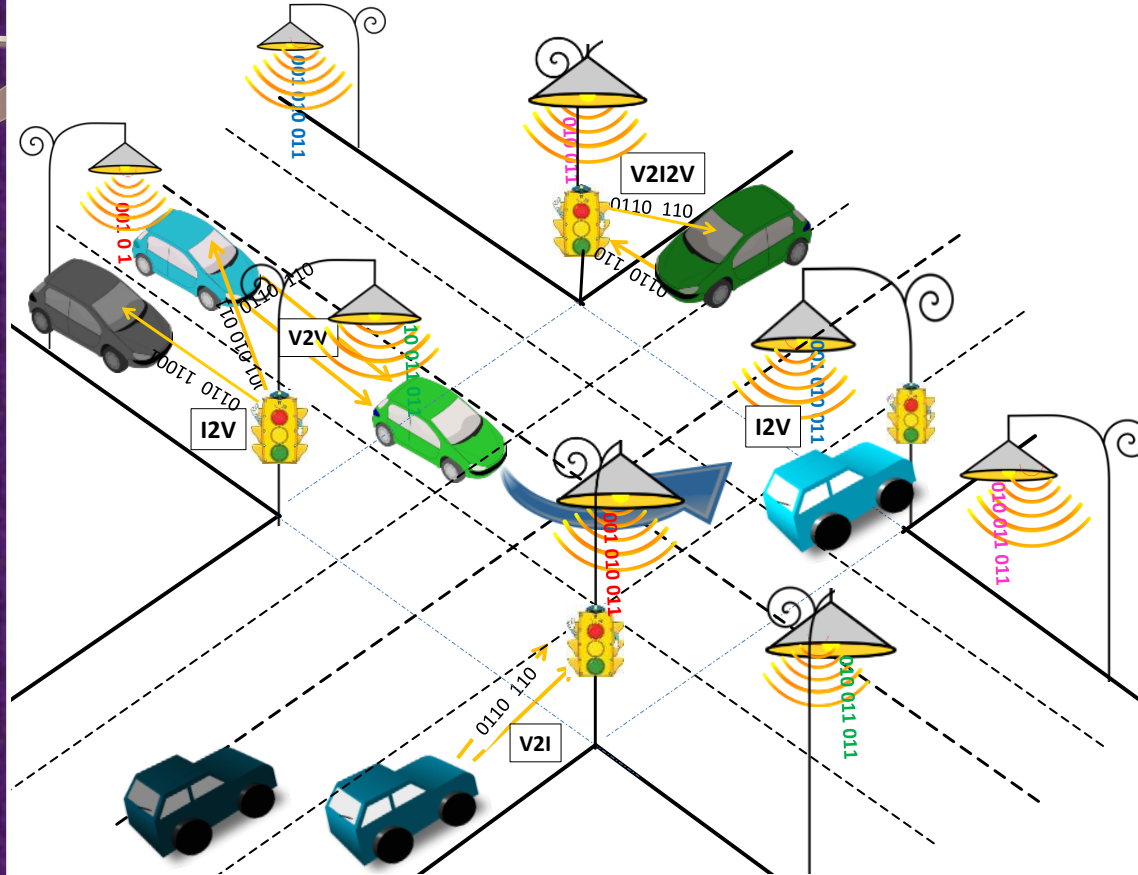

Operational procedure:

- ✓ Each vehicle receives two different messages:
 - ✓ **I2V** and **V2V** coming from the streetlight and from the follow vehicle;
- ✓ Compare them and infers the **drive distance** and the **relative speed**.
- ✓ Send the information to a next car (V2V2V) or to an infrastructure (V2V2I).
- ✓ Connected vehicles receive response messages (I2V).

- The redesign of the traffic-actuated controller uses **vehicle request/respond message information** to generate phase durations appropriate to accommodate the demand on each cycle.

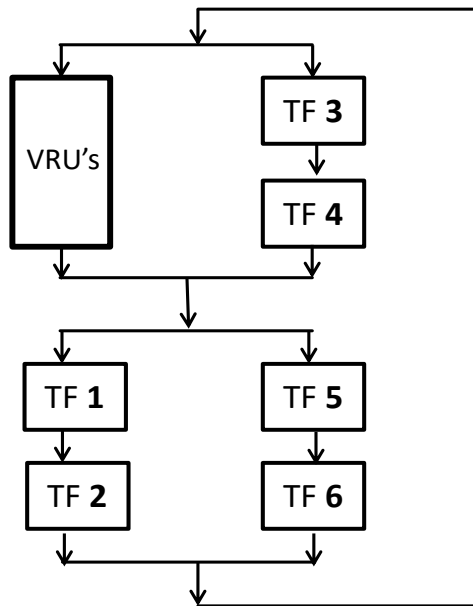
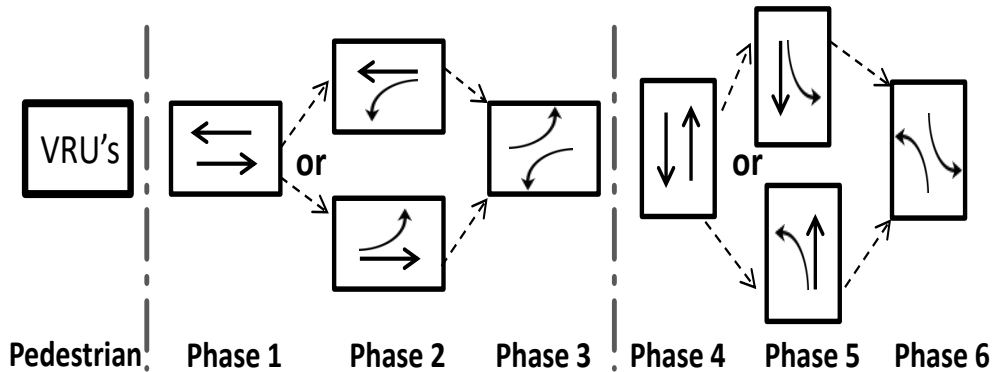

Timing function configuration.

Physical area and channelization

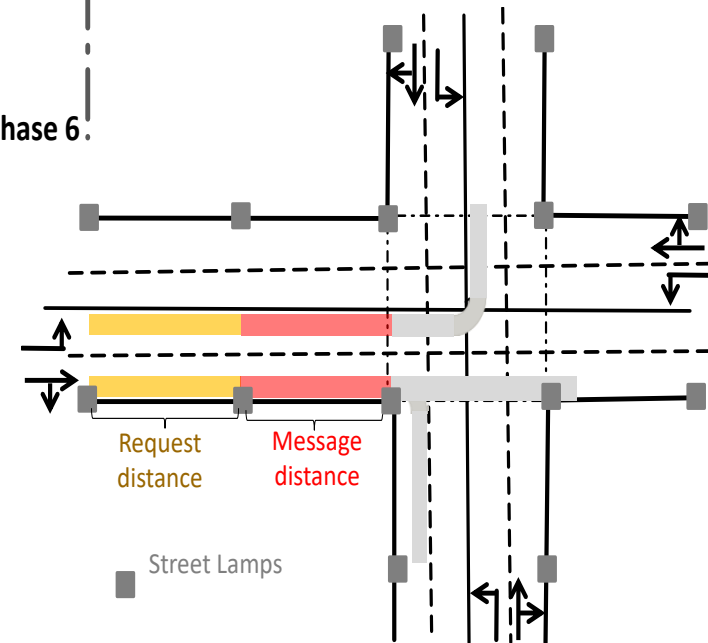

Signal timing involves the determination of the appropriate cycle length and apportionment of time among competing movements and phases.

- To build the I2V it is proposed a simplified cluster of **unit square** cells in an orthogonal topology that fills all the service area
- To realize both the communication and the street illumination, white light **tetrachromatic sources** are used providing a different data channel for each chip.
- At each node, only one chip of the LED is modulated for data transmission, the **Red**, the **Green**, the **Blue** or the **Violet** while the others provide constant current for white perception.
- Each transmitter, $X_{i,j}$, carries its own color, X , (RGBV) as well as its horizontal and vertical ID position in the surrounding network (i,j) .

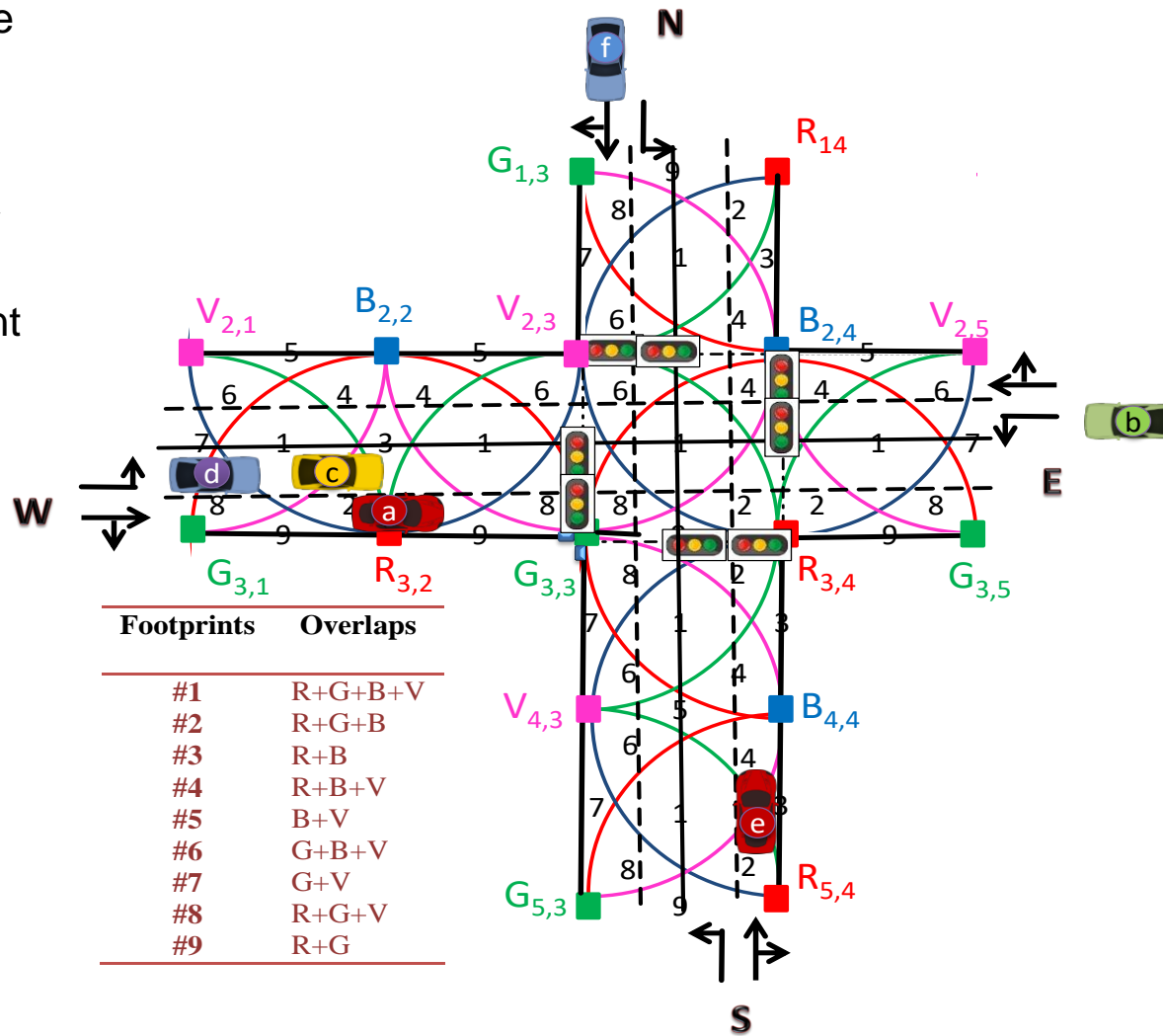

- To encode the messages an on-off keying (**OOK**) modulation scheme was used. The codification of the optical signals is synchronized and includes the information related to the ID position of the transmitters and the message to broadcast.
- A 32 bits codification was considered .

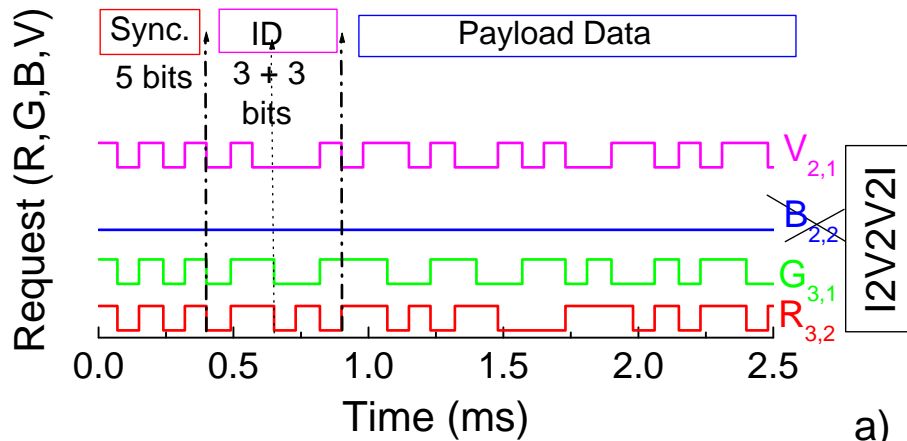

Frame structure

- Each frame is divided into three or four blocks depending on the kind of transmitter: street lamps, headlamps (a) or traffic light (b).

Codification used to drive the headlights of a vehicle in a request message from footprint #8. $R_{3,2}$, $G_{3,1}$, and $V_{2,1}$ are the transmitted node packet, in a time slot

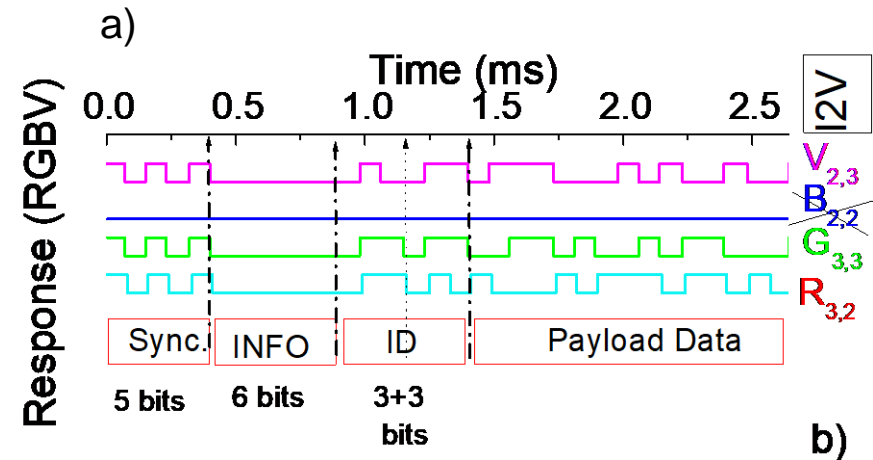
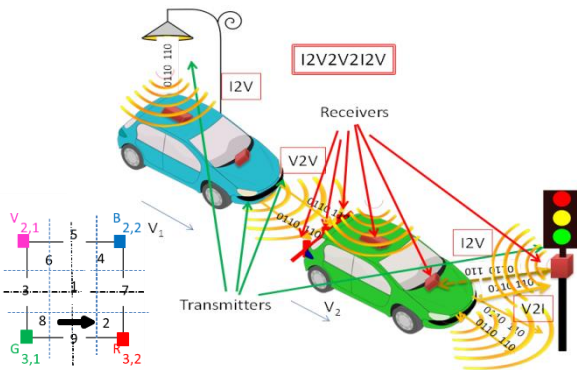

- Encoded message response of the controller to the request message of the vehicle in position #8 ($R_{3,2}$, $G_{3,1}$, and $V_{2,1}$).

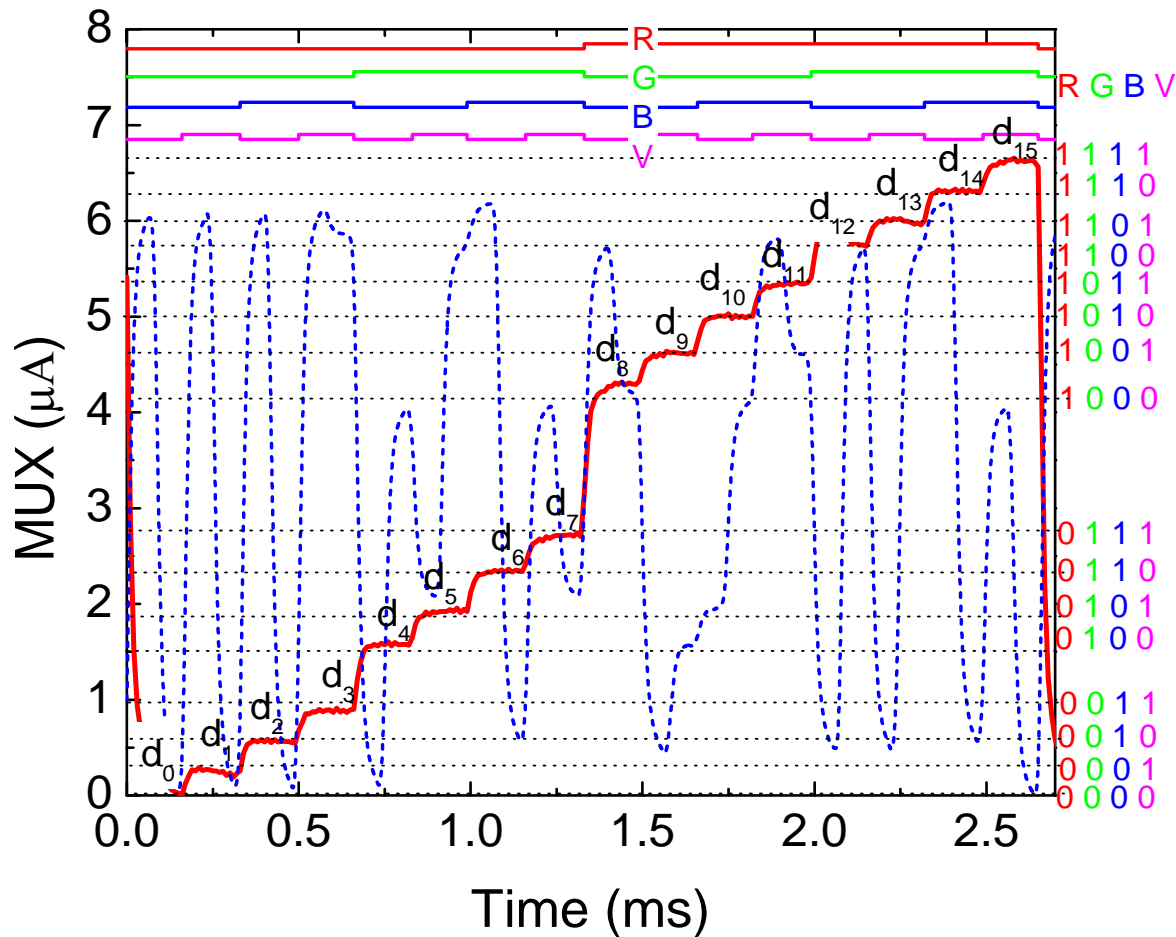

- MUX signal of the calibrated cell. On the top the transmitted channels packets [R, G, B, V] are depicted. A received MUX signal is also superimposed to exemplify the decoding algorithm.

All the levels (d_0 - d_{15}) are pointed out at the correspondent levels, and displayed as horizontal dotted lines. In the right hand side, the match between MUX levels and the 4 bits binary code assigned to each level is shown.

- Vehicle **a** enters the crossroad in position #8 (t_1) and it goes straight to position #2 (t_2) (Phase1, TF1), while vehicle **c** turn left, moving across position #1 (Phase2, TF2).

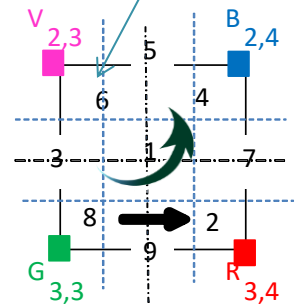
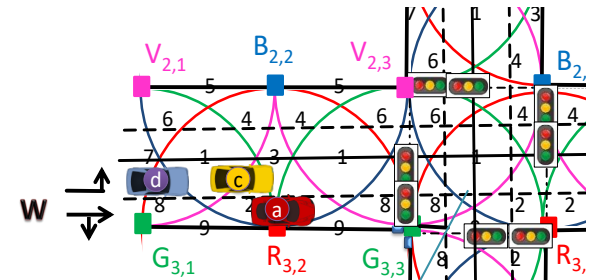
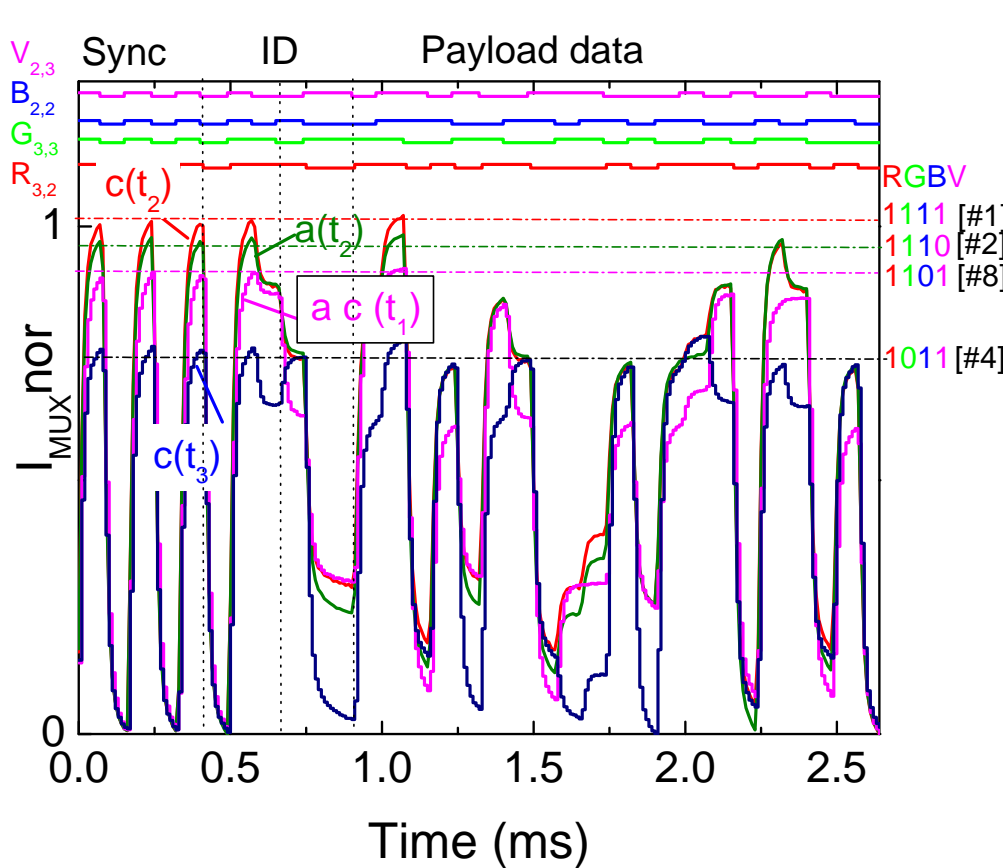

The receivers compute the geographical position in the successive instants (path) and infer the vehicle's speed. This data will be transmitted to another leader vehicle through the V2V communication or to control manager at the traffic light through V2I.

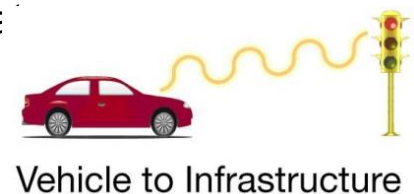

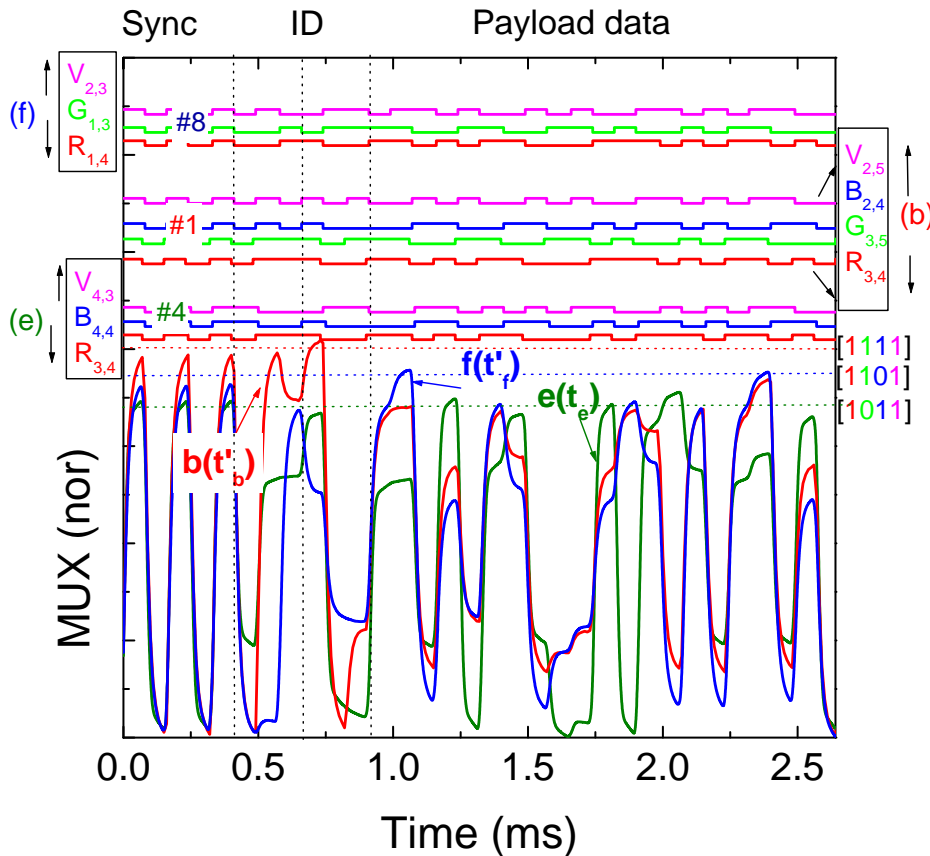

The I2V MUX signals received and decode (on the top) by the receivers of the vehicles *b*, *e* and *f* at request (t_e) and (t'_b and t'_f) response times. The 4-digit binary codes associated to the positions in the unit cell are identified at the right hand.

- Vehicles approaching the intersection from different flows are assumed to have a conflicting trajectory

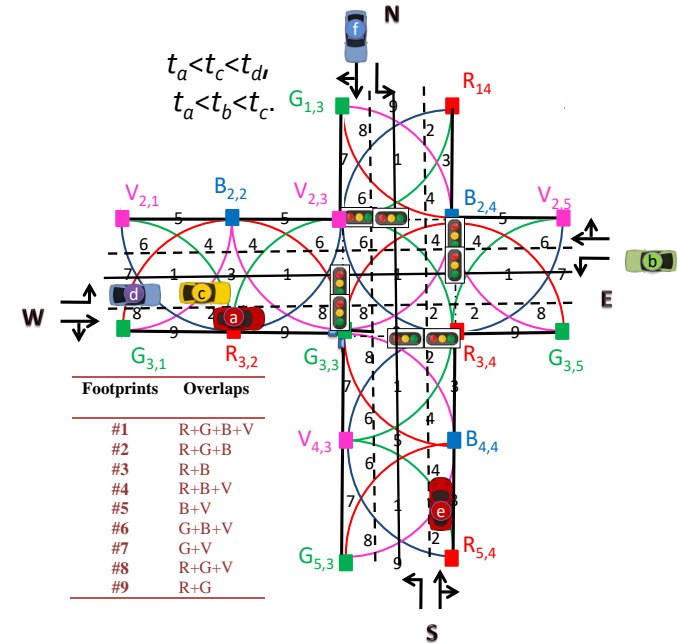

- All the requests contain vehicle positions and approach speeds. If a follower exists (Vehicle *d*), the request message from its leader includes the position and speed previously received by V2V. This information alerts the controller to a later request message (V2I), confirmed by the follow vehicle.



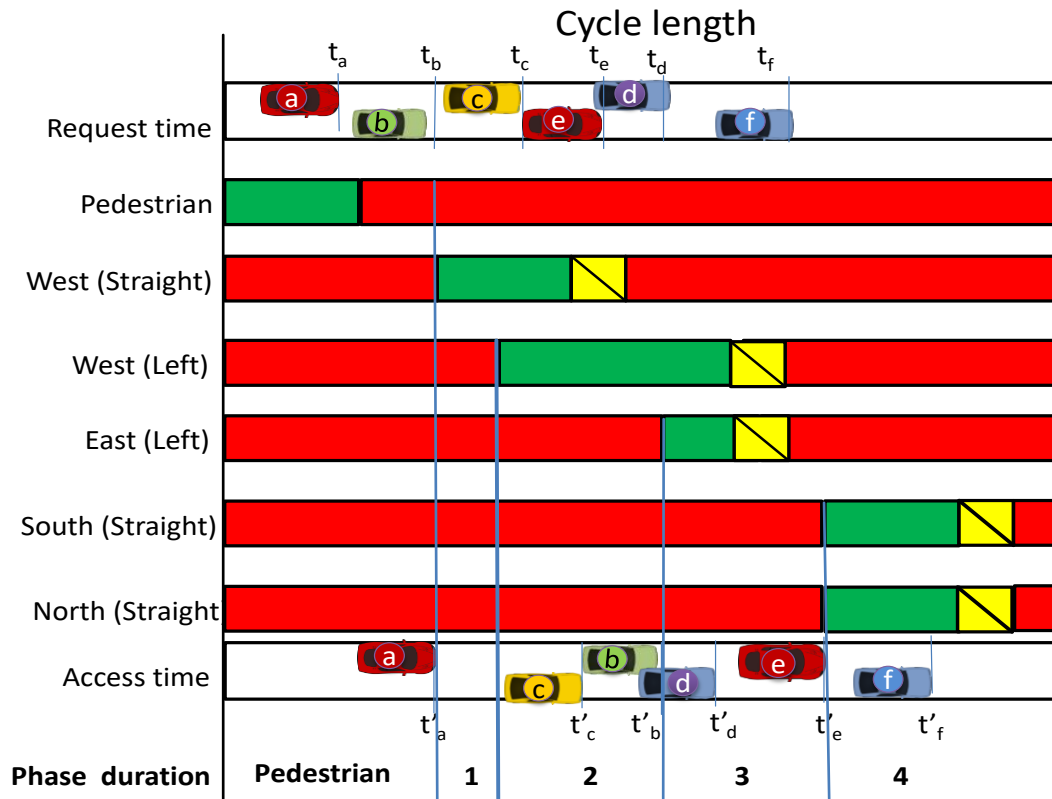

- **Signal phasing** is the sequence of individual signal phases within a cycle that define the order in which pedestrians and vehicular movements are assigned the right-of-way.
- **Redesign traffic-actuated controller** uses a, b, c, d, e and f vehicles requesting and responding message information to generate phase durations appropriate to accommodate the demand on each cycle. Each driving vehicle is assigned an individualised time to request (t) and access (t') the intersection.

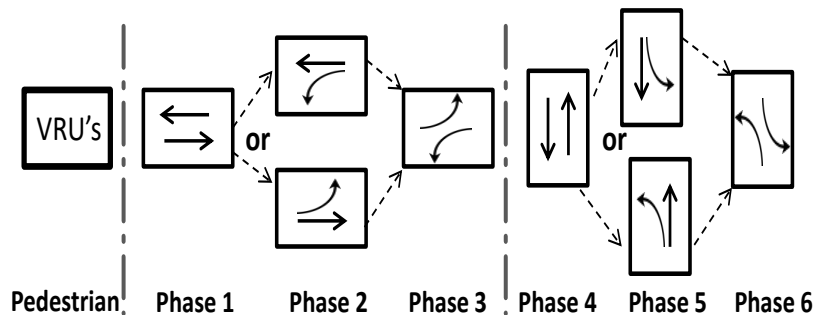

Phasing of traffic flows:

Pedestrian phase, Phase 1 (W straight flow), Phase 2 (W straight and left flows), Phase 3 (W and E left flows), Phase 4 (N and S straight flows).

Information flow towards the traffic light: Improvement of control by precise information about traffic

Traffic Light Phase Assistant NETWORK

Locations, speeds, and accelerations of all CVs at a given time t are placed in a virtual roadway

Signal phases and timing adapt to the real time traffic conditions.
Traffic actuated.
More efficient.

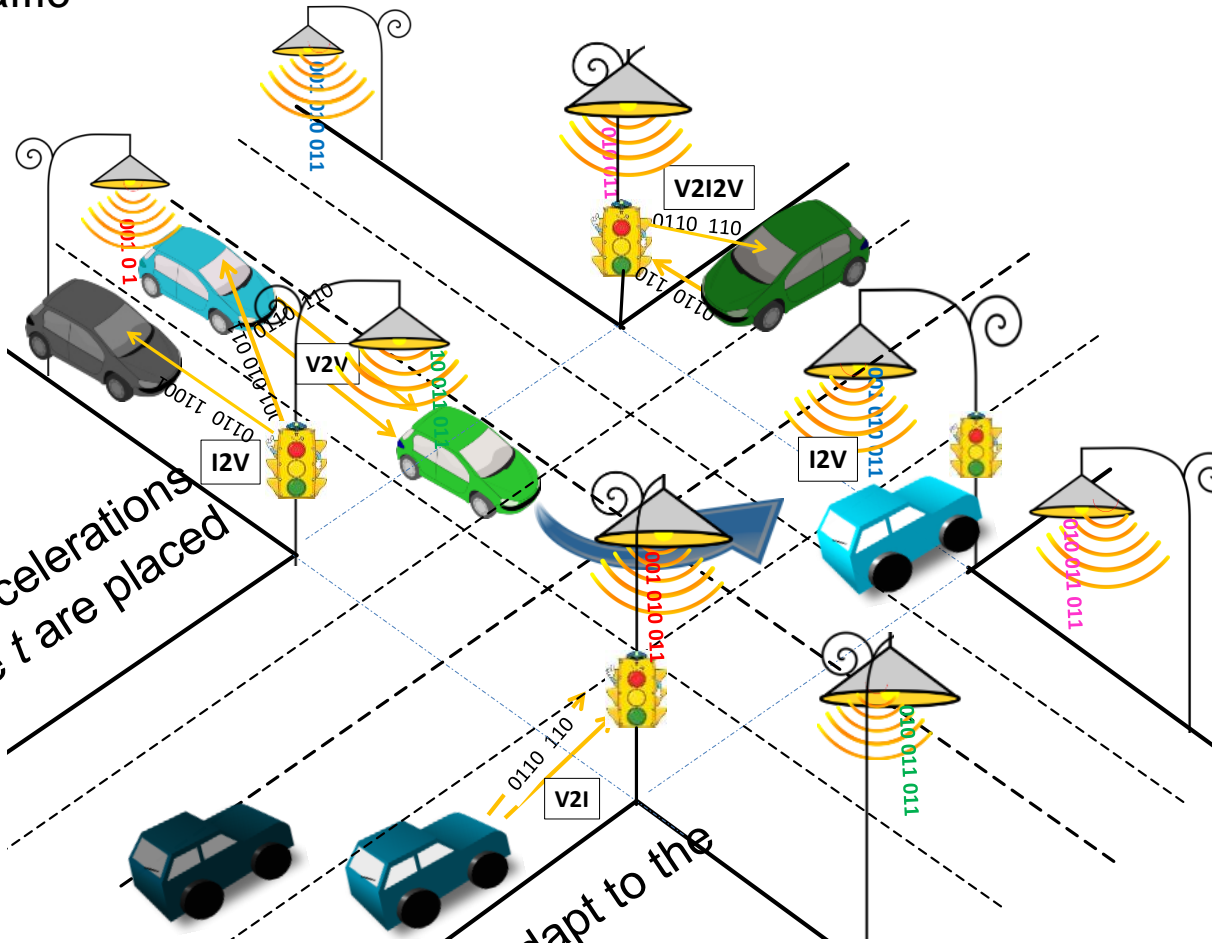

- ❖ Light-activated pi-n/pin a-SiC:H devices combine the demultiplexing operation with the simultaneous photodetection and self amplification.
- ❖ Connected vehicles information from the network (I2V), vehicular interaction (V2V) and infrastructure (V2I) is analyzed.
- ❖ A generic model of cooperative transmissions for vehicular communications services is established.
- ❖ The experimental results, confirmed that the proposed cooperative VLC architecture is **appropriate** for the **control and management of a traffic light controlled crossroad network**.
- ❖ **Two-level optimization:** phase sequence and duration.

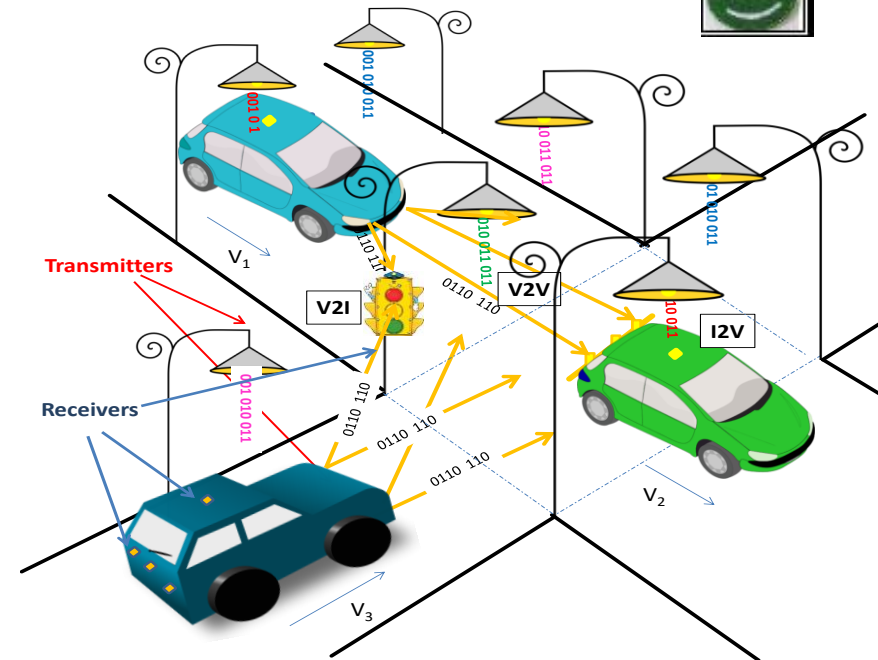
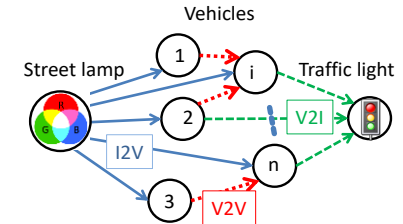
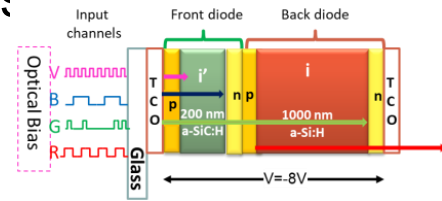

SILICON PHOTONICS FOR BIOSENSING APPLICATIONS



Alessandro Fantoni

What is Silicon Photonics?

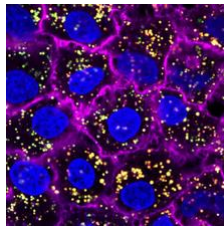

A Disruptive Technology:

- Monolithic optoelectronic devices produced in low cost Si process

The Vision:

- Delivering optical connectivity everywhere, from network to chip level

Technology

- SOI wafer level in (back end) CMOS process

Why Silicon Photonics?

The rationale of silicon photonics is to apply the paradigm of microelectronics to photonics by manufacturing various devices in a single material (silicon) and using a single manufacturing process: the CMOS process

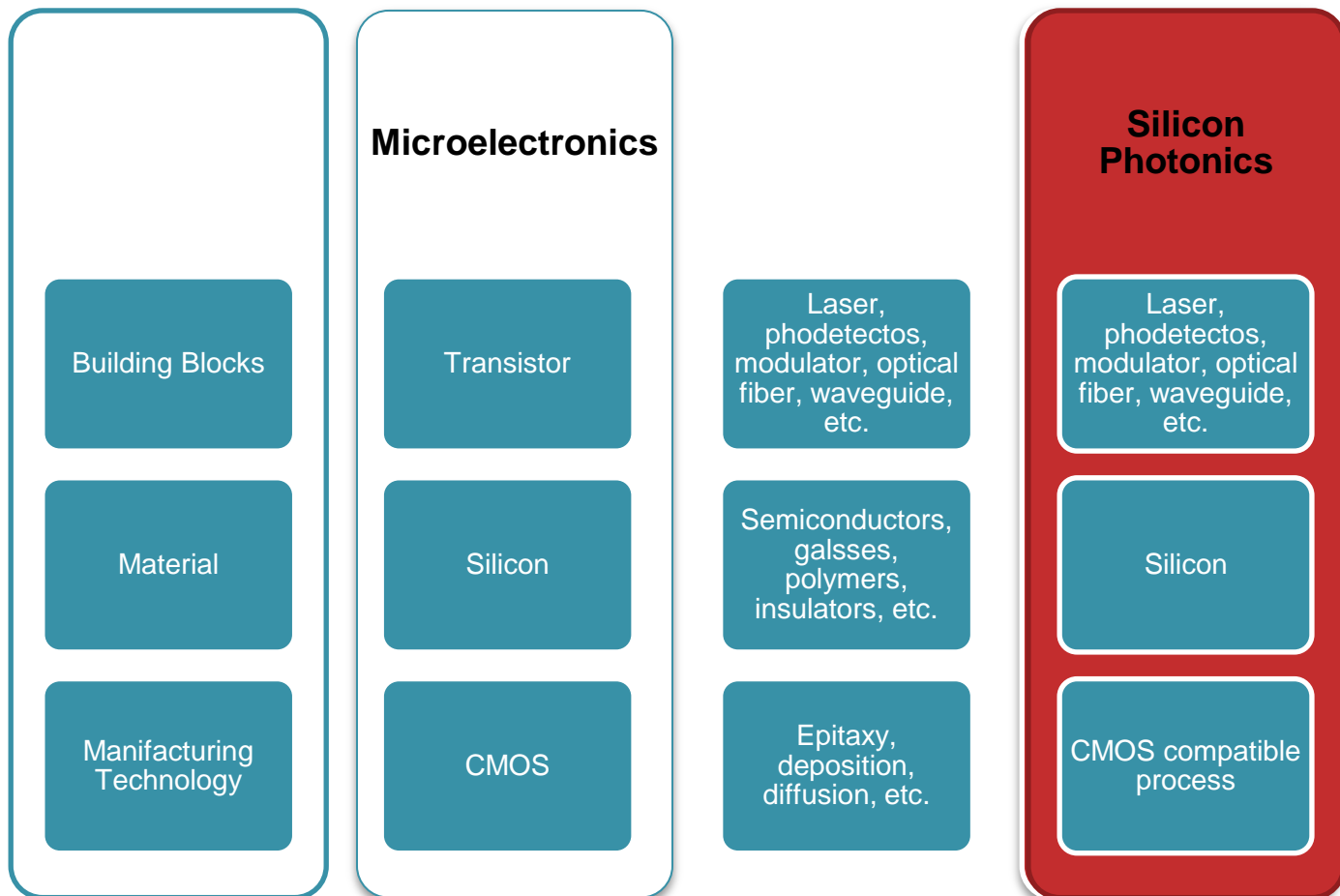

Silicon for optics and photonics

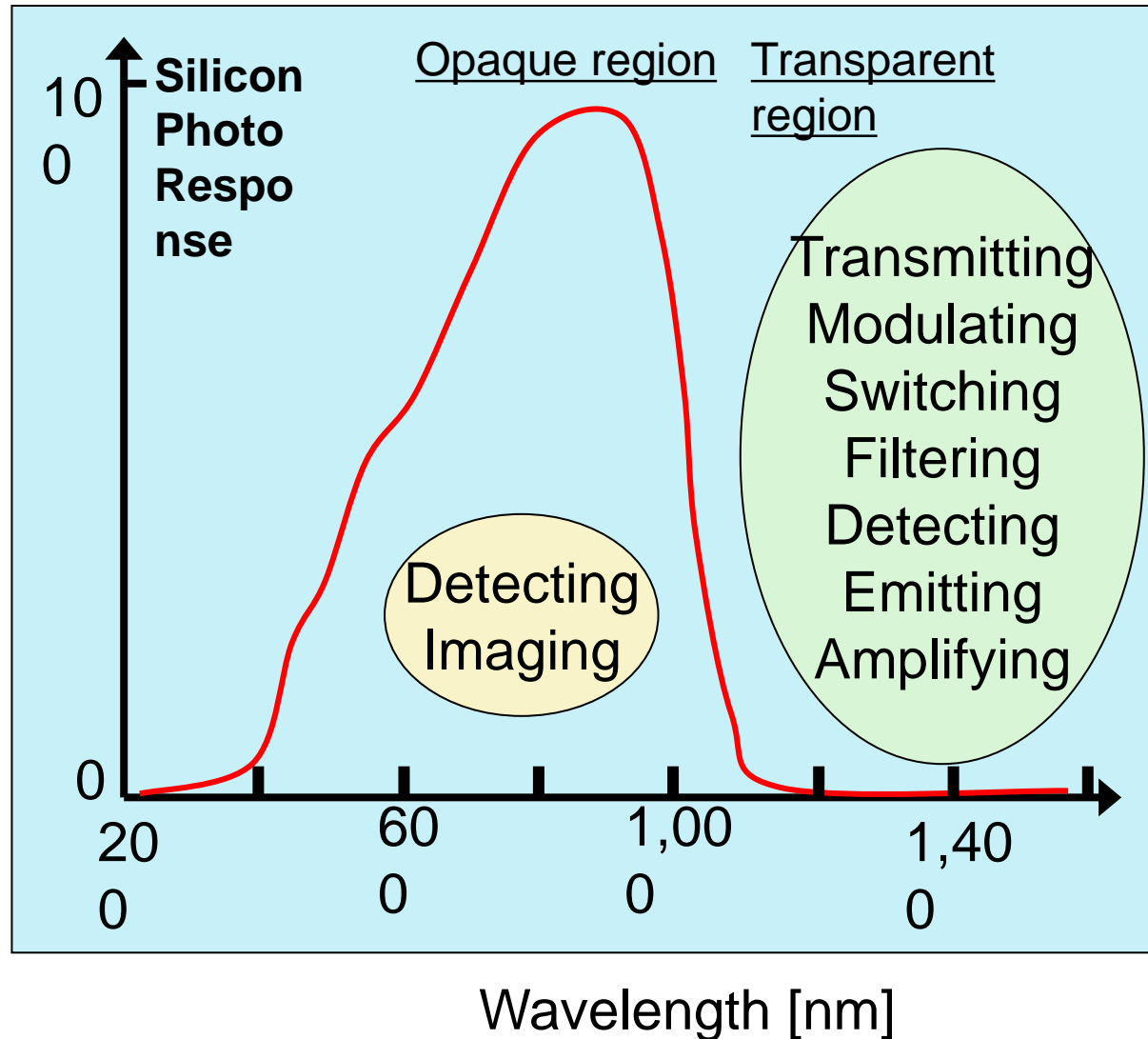

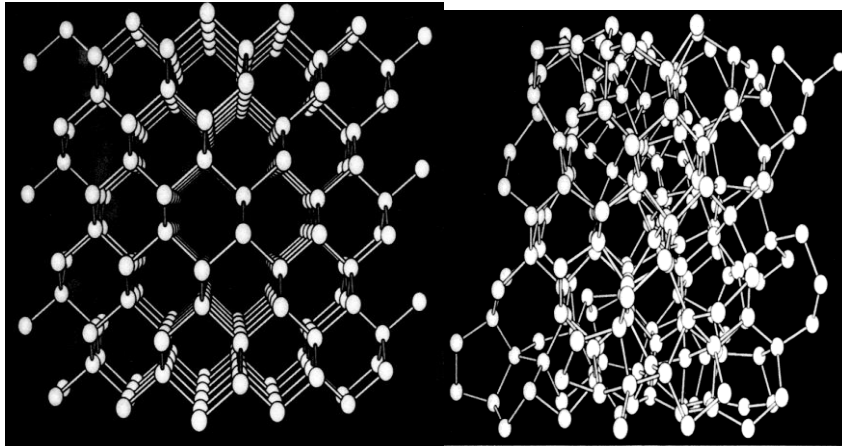

Wooten, F. and Winer, K. and Weaire, D.
 Computer Generation of Structural Models of Amorphous
 Si and Ge
 Phys. Rev. Lett. 54 1392 (1985)

Amorphous silicon open the range of the operational wavelengths to the Near-IR range

Real n and imaginary k part of the index of refraction for relaxed amorphous silicon as function of wavelength, obtained from spectroscopic ellipsometry measurements. The index is compared to literature values for crystalline silicon (dashed lines). In the near infrared part of the spectrum (> 1100 nm) the refractive index of amorphous is typically 0.3 higher than that of crystalline silicon, while the absorption is small.

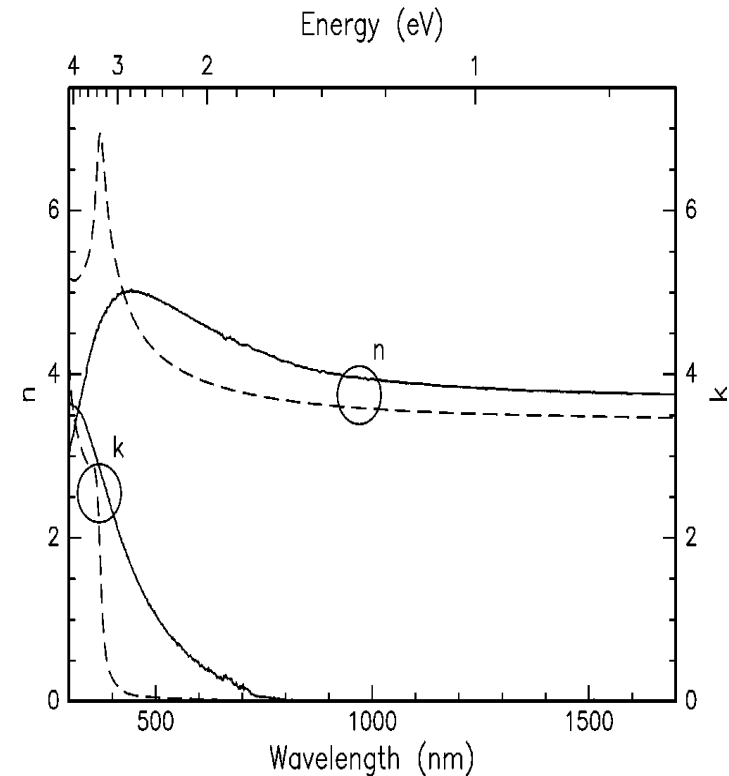

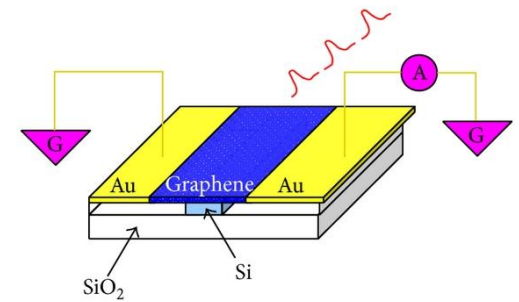

- Silicon photonics is currently at the same early stage of expansion as electronics was in the 1970s, but with a major advantage for chip fabrication: existing silicon foundries for microelectronics
- Silicon on Insulator (SOI) are the common wafer for PICs
- PECVD a-Si:H can be used as a low-cost alternative
- PECVD Silicon Nitrate (Si_3N_4) allow the waveguide to work in the visible range (Red part of the spectrum).



PIX4life started with a grant from the EC within the H2020 framework. Once the grant to set up the pilot line is finished, PIX4life will remain offering its services through the different partners and other

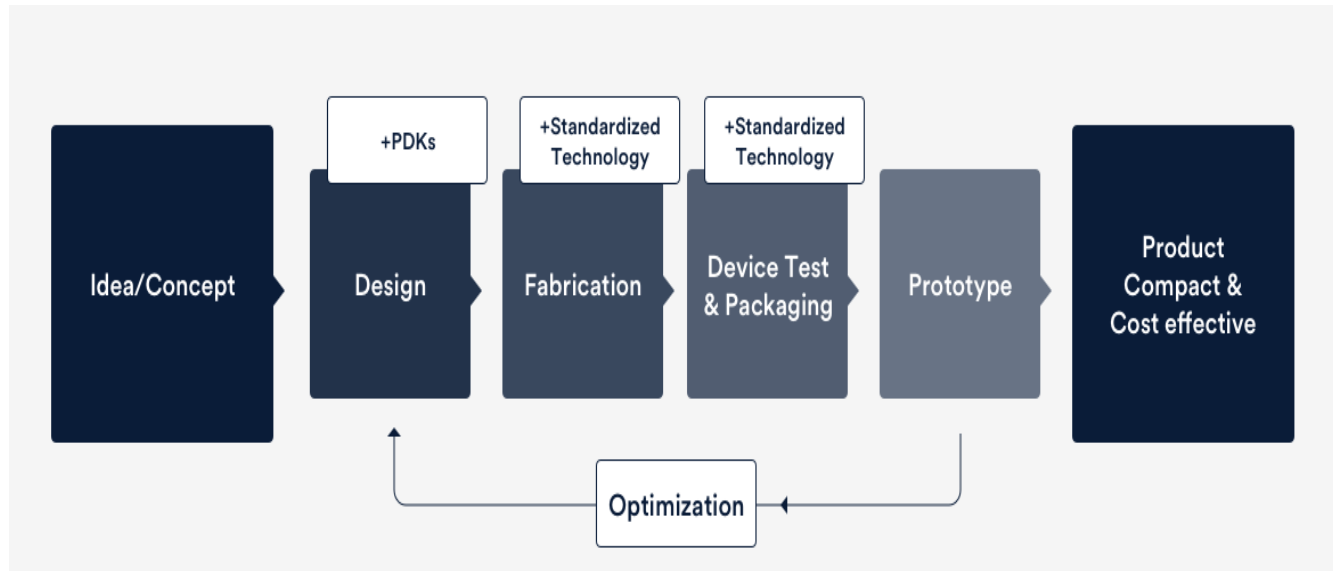

Silicon nitride integrated technology enables many different applications on biophotonics and life-science applications in which light might be utilized as sensing mechanism or as instrument. The biggest advantage of silicon nitride is that it is completely passive and has no fluorescence on the visible range.

PIX4life provides silicon nitride integrated technology specially optimized for such applications.

Waveguide propagation properties

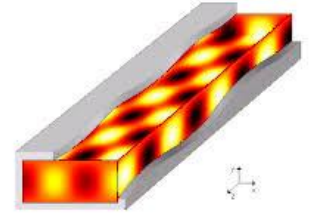

- n_{eff} quantifies the phase delay per unit length in a waveguide, relative to the phase delay in vacuum.
- n_{eff} , also called *modal index*, depends on.
 - the wavelength
 - the mode in which the light propagates
- n_{eff} can be a complex number. The imaginary part quantifies losses
- Exact value of n_{eff} can be calculated by using numerical methods
- n_{eff} can be approximated by a weighted average of the refractive waveguide index of core and cladding, determining the weight factors by the fractions of the optical power propagating in the core and cladding.

Calculation of n_{eff} for a waveguide with $n=1.5$

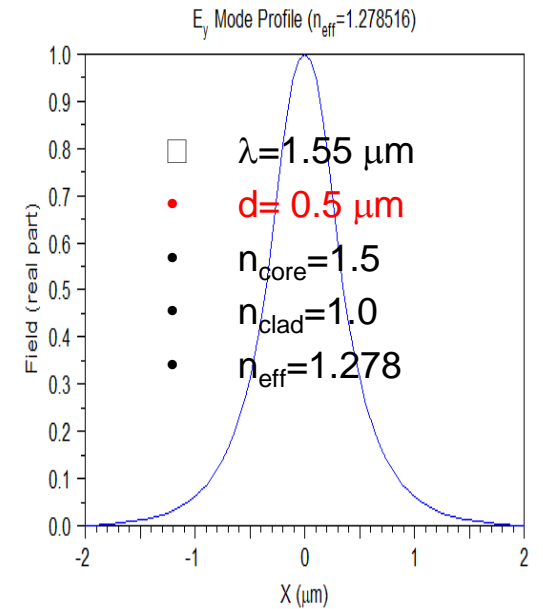
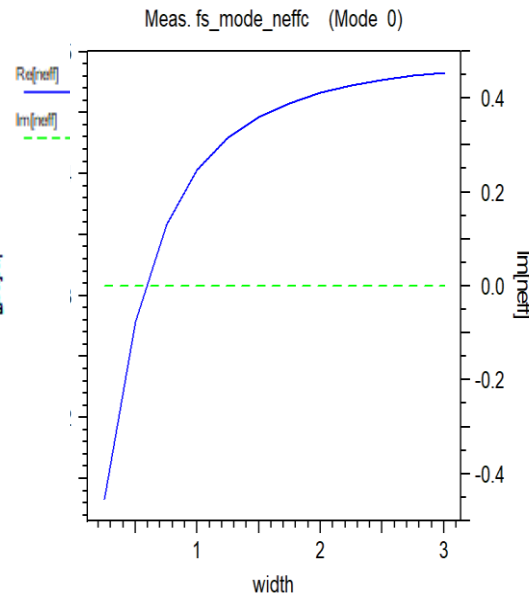
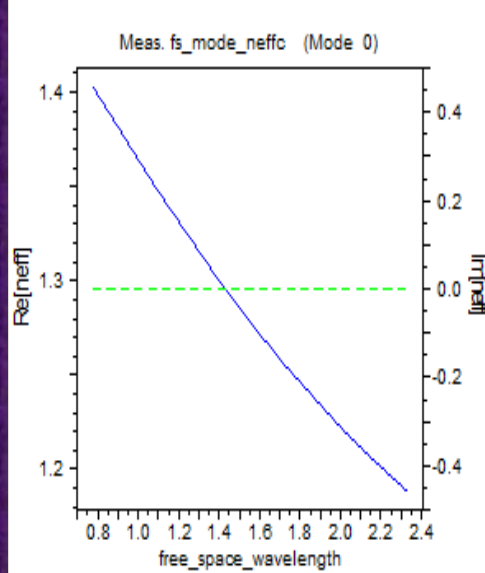
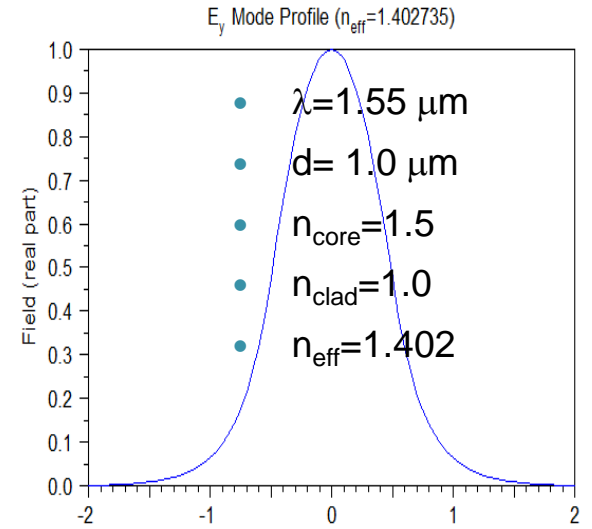
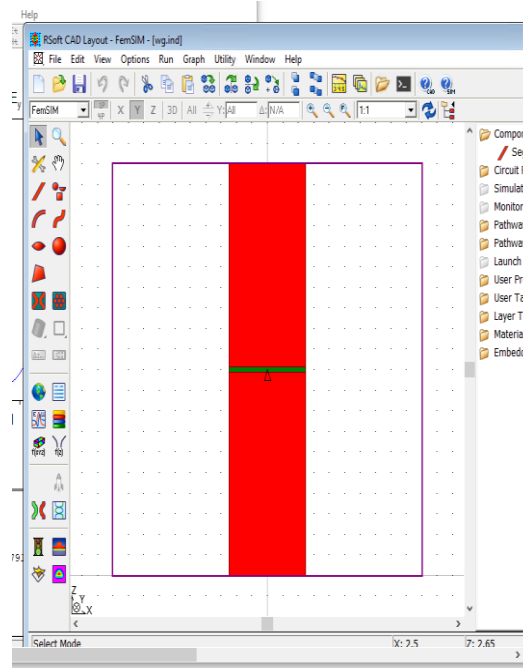
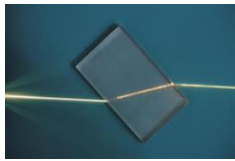

Basic Principle of Photonic Biosensors

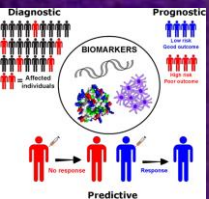
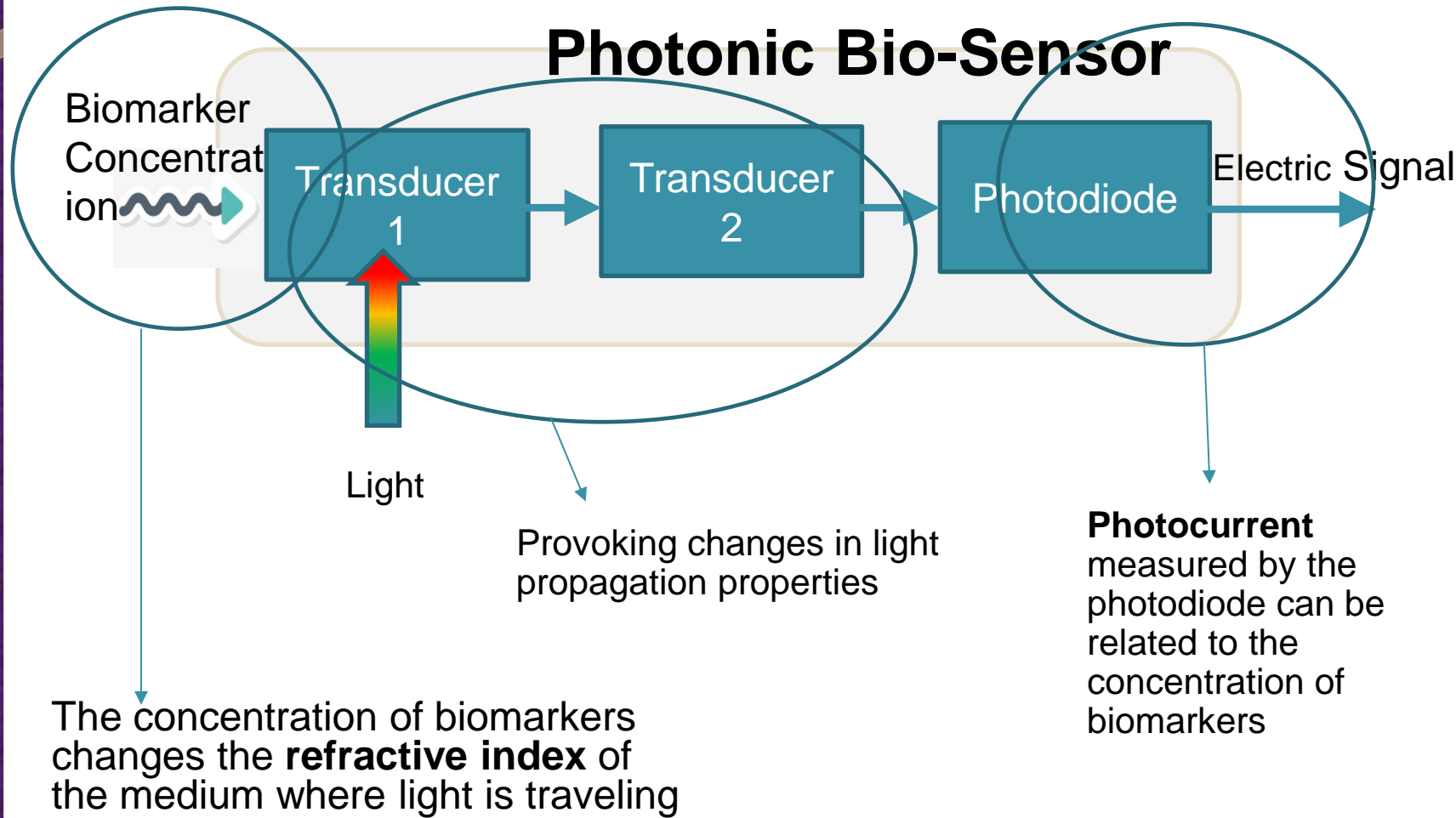

Plasmonic Interferometer

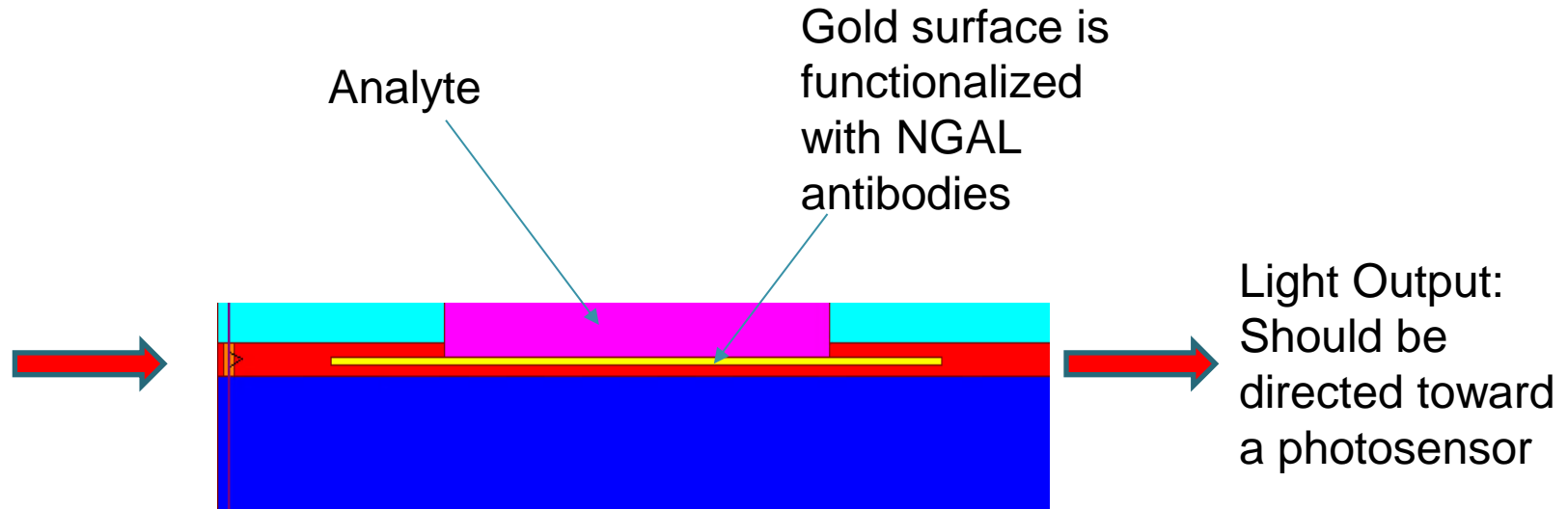

Light input: already coupled to the waveguide through grating coupler

- A surface plasmon interferometer consists of a thin layer of gold embedded in the silicon membrane working as an interferometer
- Interferometer structure:
 - SiO₂(blue)
 - SiN_x (red)
 - Au(Yellow).
 - Water(cyan) and Analyte(purple) only exist during sensor utilization

HOW DOES IT WORK?

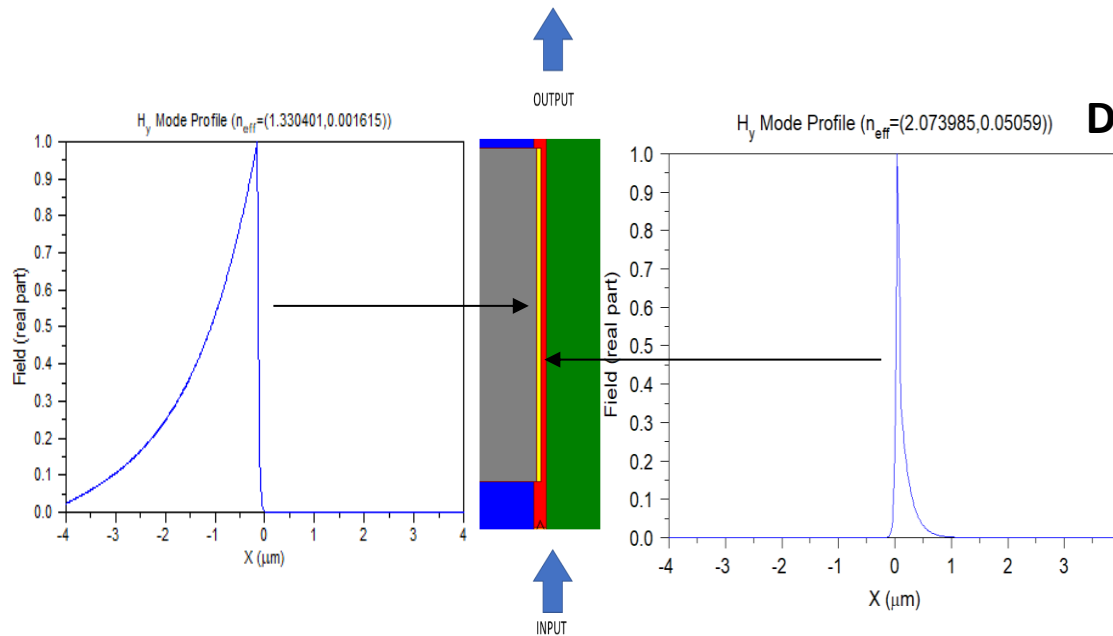

SPP sample medium –gold
 $n_{\text{eff}}=1.33$

- Light incident on the plate from the propagating mode in the SOI waveguide couples into **two surface plasmon modes**, one on each side of the metal plate.
- These two modes, because of the different indices present on either side of the plate, will have **different propagating constants** resulting in a path length difference.
- The two modes then **interfere at the end of the plate** resulting in varied power output. The power output can then be correlated to the refractive index of the test material, and therefore the quantity to be detected.

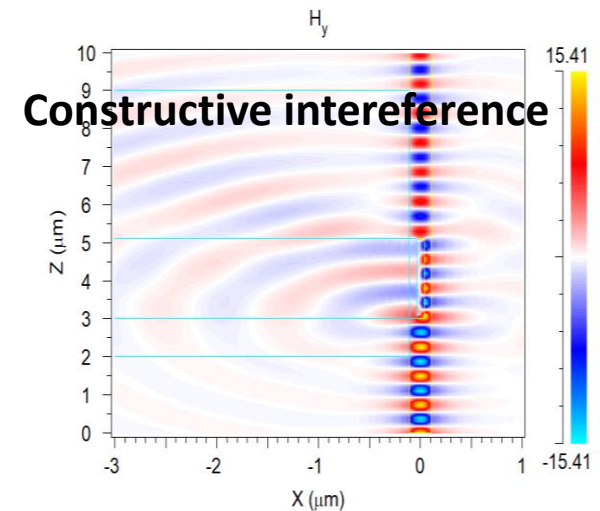
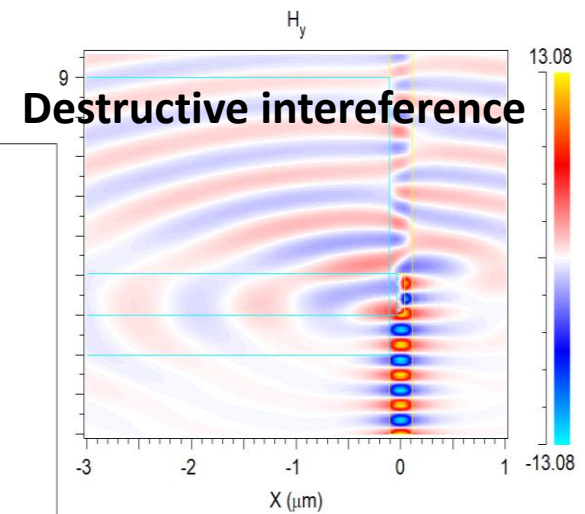

Interferometer length L for **destructive** and **constructive** interference:
 $L=1.05 \mu\text{m}$ and $L=2.1 \mu\text{m}$, respectively

The Output of the Plasmonic interferometer

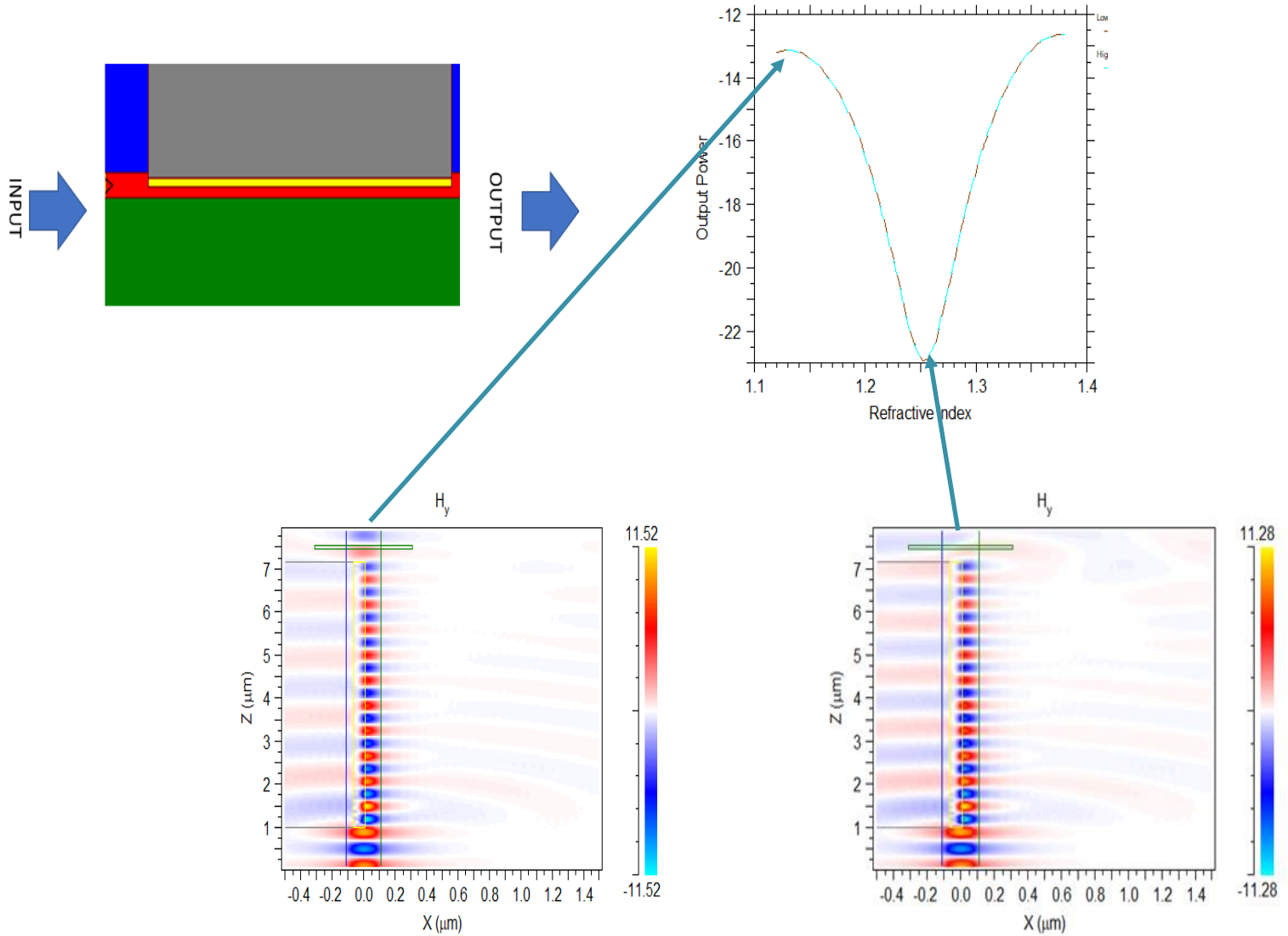

Interrogation scheme: extracting the output

The Interferometer is very sensitive to any change of the analyte refractive index

- A fine tuning of all the dimension is needed to obtain a good calibration of the device
- A light wavelength scan is needed for extracting the sensor output



**Need a High definition lithography:
EXPENSIVE
TECHNOLOGY**



**Need for a wavelength tuneable laser:
EXPENSIVE
TECHNOLOGY**

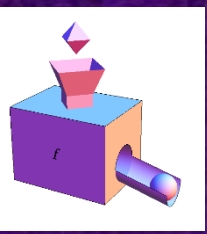

The PhotoAKI alternative output scheme

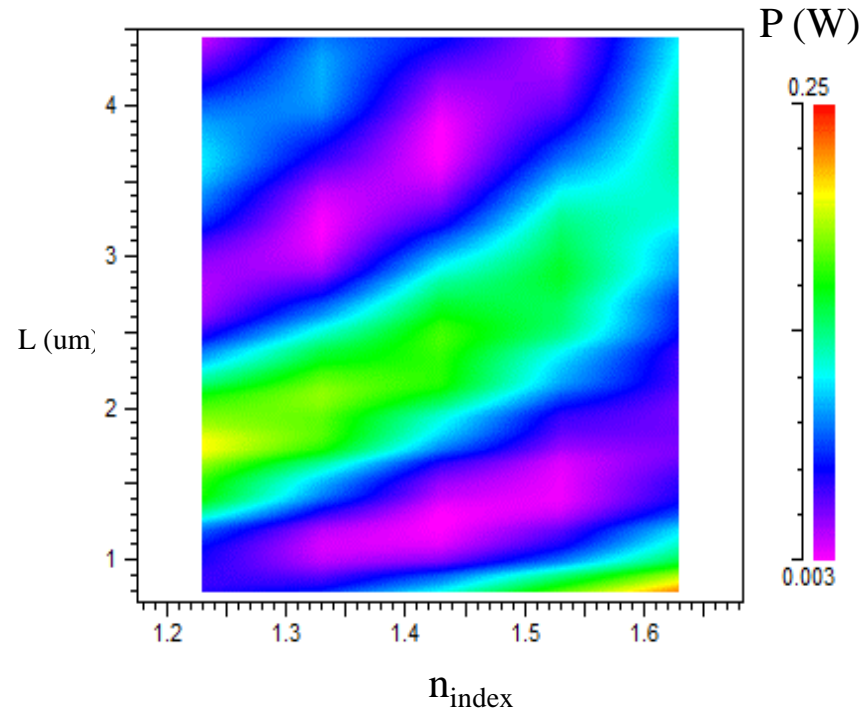

- Once fixed the light wavelength, the transmitted power depends on:
 - **the refractive index of the sampling medium**
 - **the length L of the interferometer.**
- The periodicity of the output power as a function of L can be seen as well as the shift in the position of the minima and maxima as a function of the refractive index.

The arrayed Interrogation Scheme

- Aiming to reduce this complexity in the output extraction we propose an array of interferometers, each one with a regularly increasing length.
- The interrogation scheme is based in determining in which part of the waveguide array is located the minimum light intensity.
- Without the need of any optomechanical system, the complexity of the sensor readout is strongly reduced by this alternative method.

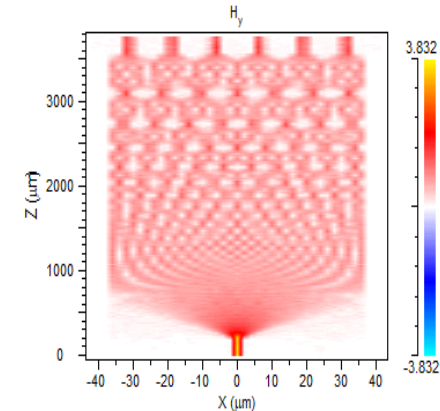

Output signals to the photodetector

Interferometers

MMI

Input Waveguide

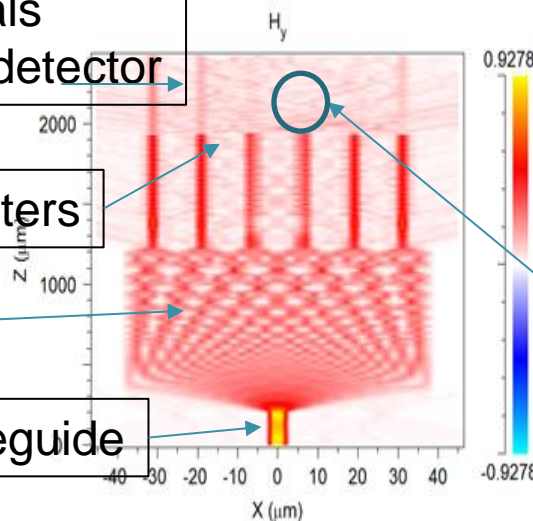

- An MMI splitter divide the light in a certain number of equally balanced waveguides.
- To each waveguide corresponds an interferometer with a different length

Output waveguide with minimum light intensity. This localization depends on the analyte properties

To each waveguide corresponds an interferometer with a different length



- Transmitted power for the 8 parallel waveguides and for three different refraction indexes n of the sampling medium. We can observe the minimum transmitted power shifting from the 4th to the 6th waveguide as the refractive index increases from $n=1.2$ to $n=1.4$.

The schematic of the setup is presented.

- In order to excite the parallel waveguides a Multi-Mode Interference (MMI) device is used in a 1-to-8 splitter operation mode. Such operation mode can be achieved by center feeding the MMI with a symmetric field profile and adjusting the length of the device, L_{MMI} , to the exact distance where the N-fold images are generated. A zoom of the interferometer region is highlighted in the circle.

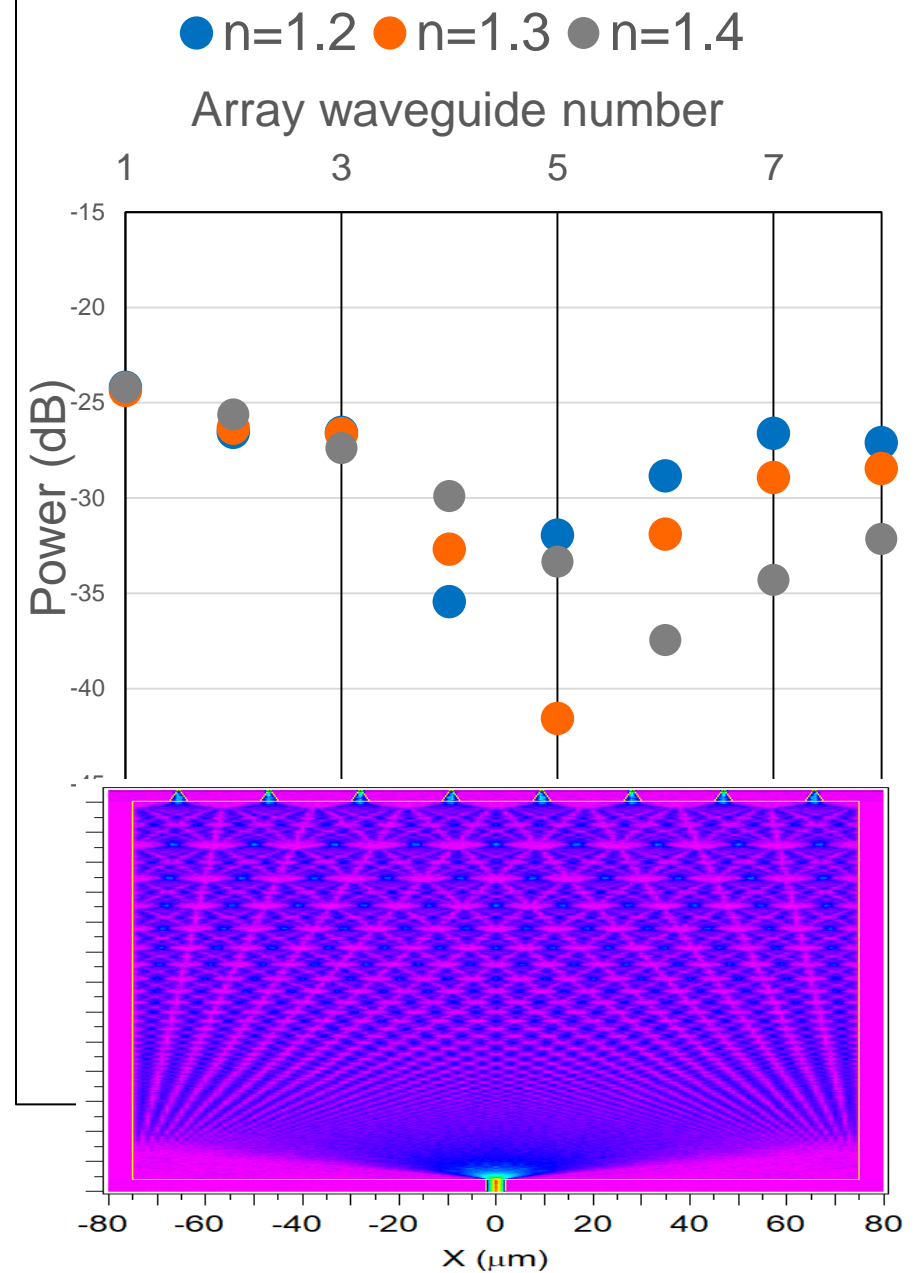
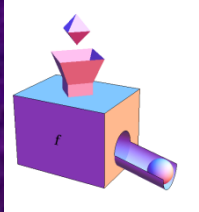

- Light Emitter: External Laser (650nm)
- Light waveguide Coupling : Grating coupler on a PECVD SiNx waveguide
- MMI Splitter: divide the input light in a set of balanced waveguides
- Interferometer:
- Light detector:
 - a-Si:H photodiode/phototransistor
- Signal Processing:
 - CMOS circuitry integrated with Photonic layer

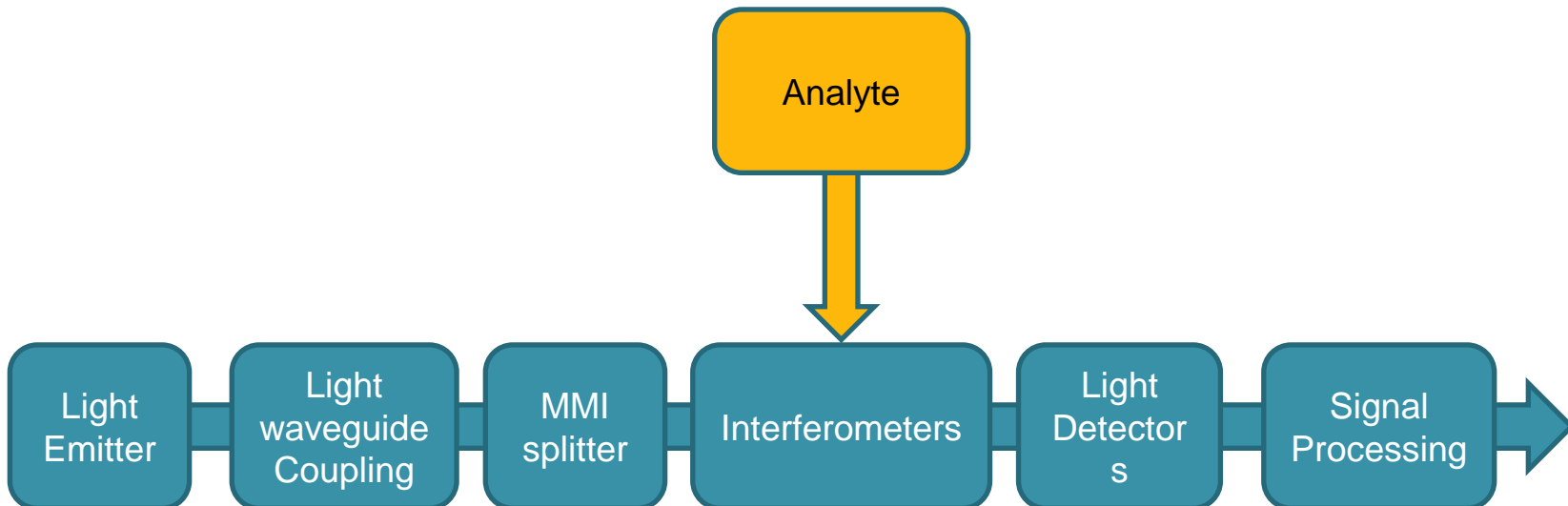

- ❖ PECVD thin film materials can be used for building low cost photonic chips with potential application in the field of bio-sensing.
- ❖ The compromise between production costs and device efficiency paves the way to affordable Lab-on-chip systems to be used in point of care testing.

RADIO PLANNING



Pedro Vieira

ISEL
INSTITUTO SUPERIOR DE
ENGENHARIA DE LISBOA

it instituto de
telecomunicações

CELFINET
outstanding networks

The beginning...

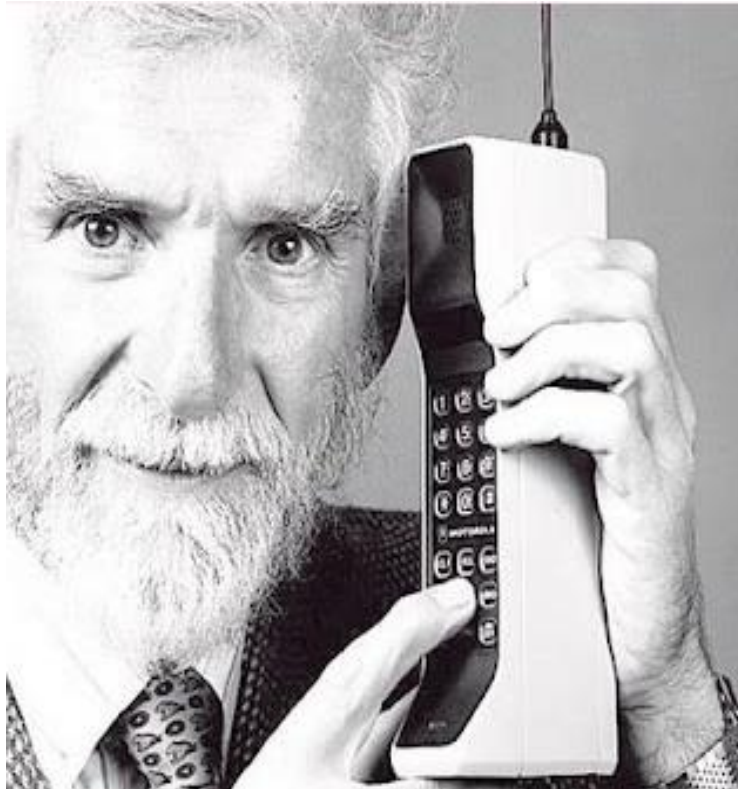

DynaTACTM Cellular Phone, Motorola, 1973, (1089 g) by Martin Cooper.

The present... Radio Access Network (RAN)



RAN PLANNING AND OPTIMISATION

The Cellular Concept

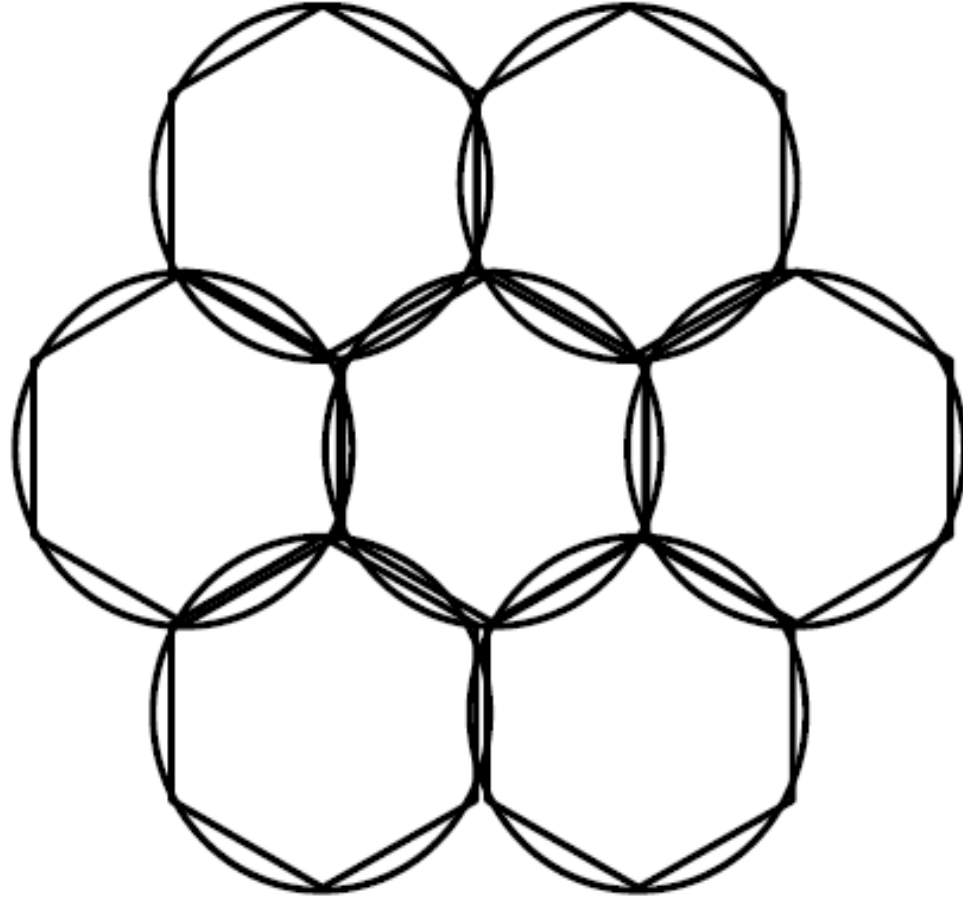

Macro-cell Base Stations



Micro-cell Base Stations

RAN PLANNING AND
OPTIMISATION

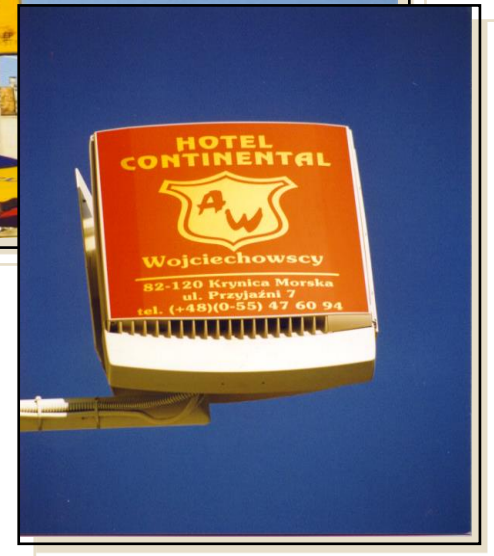

Pico-cell Base Stations



Femto-cell Base Stations

Macro 2G/3G



[Source: <http://www.vodafone.pt>].

The RNPO Process...

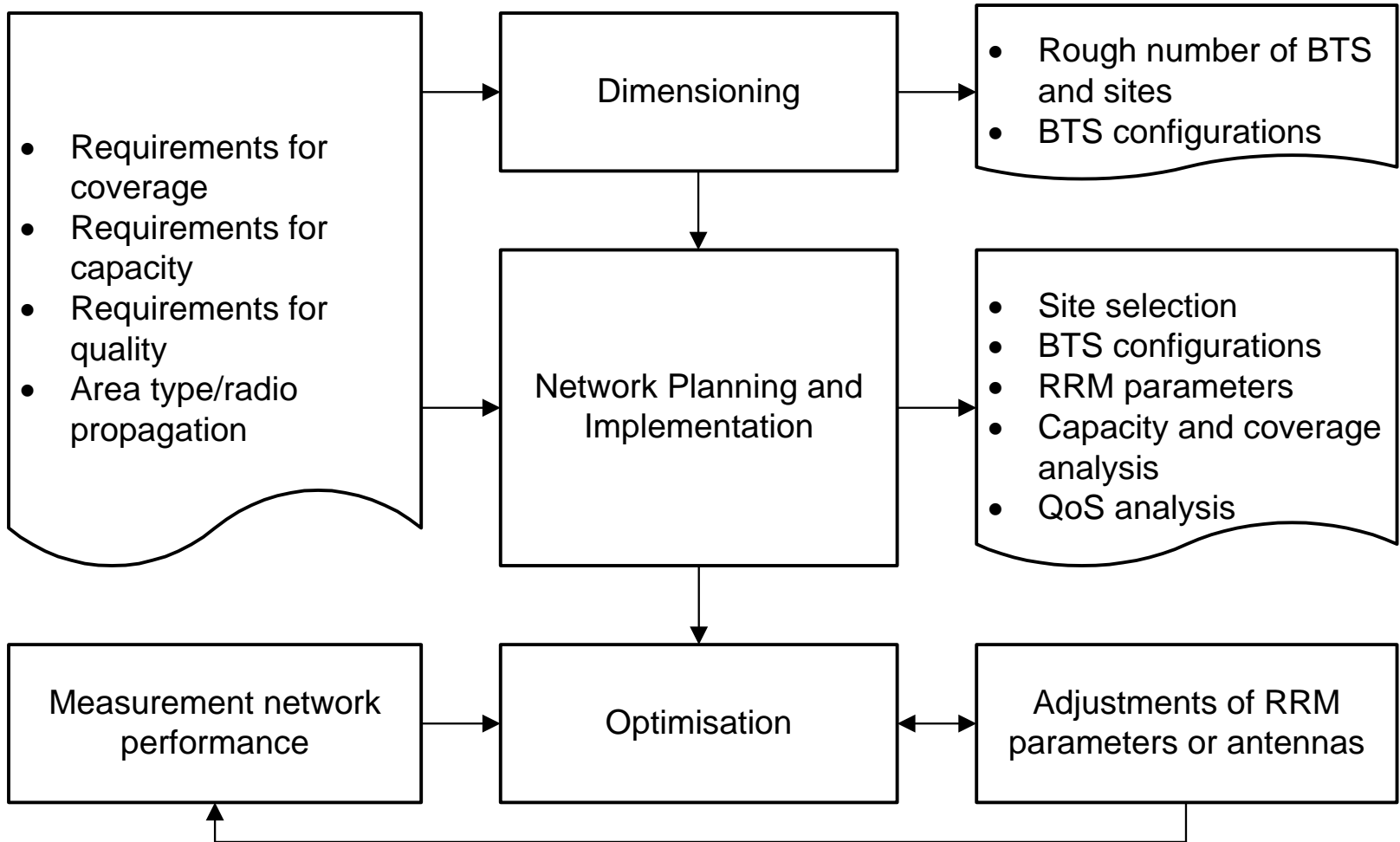

The Network...





Pedro Vieira

GEO-LOCATION (RF)

ISEL
INSTITUTO SUPERIOR DE
ENGENHARIA DE LISBOA

it instituto de
telecomunicações

CELFINET
outstanding networks

- RF Planning

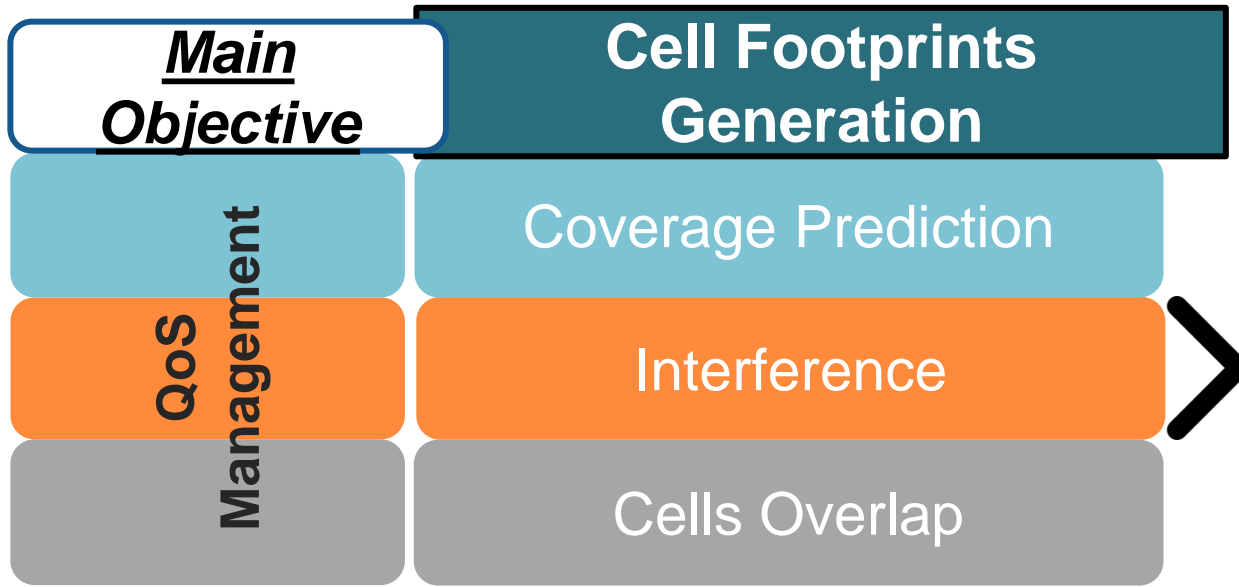

Coverage Maps

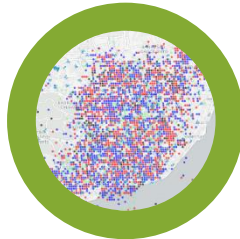

Interference Maps



Context Aware



Geo-location

- RF Planning

Propagation Modelling and Geo-Location

• RF Planning

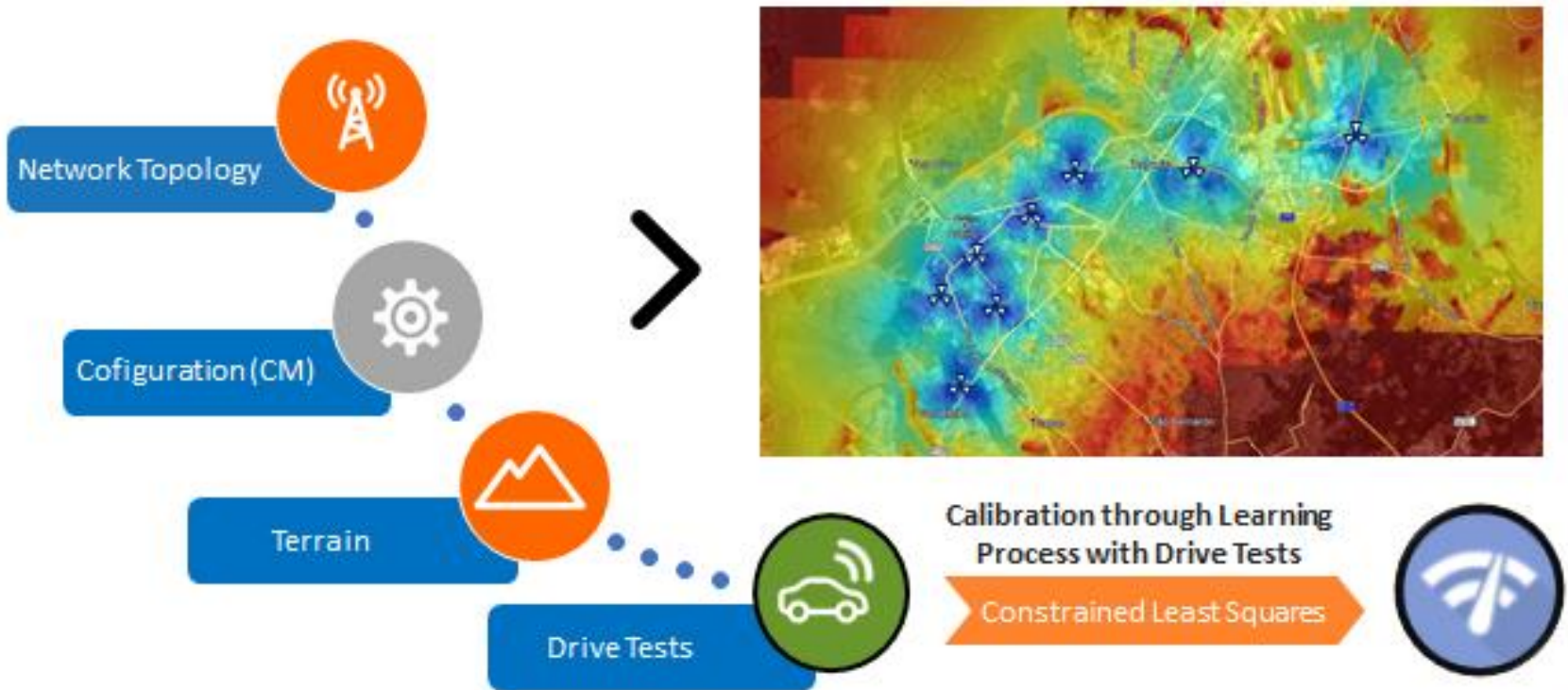

PROPAGATION MODELLING AND GEO-LOCATION

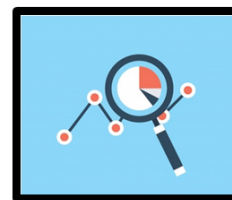
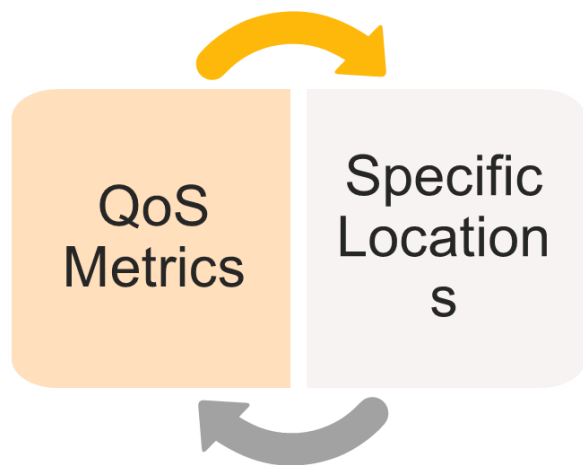

Network Performance Metrics

Signal Measures

Cells Capacity

Users Profile

KPIs



QoS Remote Network Metrics



CAPEX/OP EX Reduction



Energy Savings



IMSIs Location



Context Aware

- **Geolocation RF**

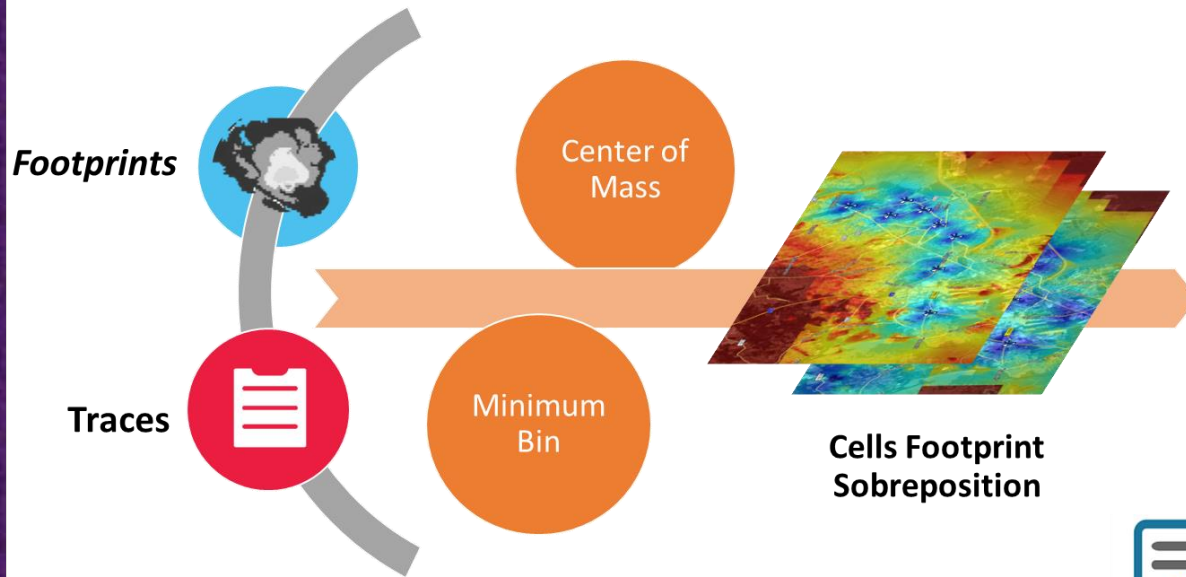

Positioning Error	
Mean Error [m]	Median Error [m]
200	150



**Use Cases
Production and
Reporting**

3G/4G Layer 3 Protocol Messages



- Protocol messages exchanged within the network and the users.



- Useful information in terms of network performance metrics.



Prop. Delay



Cell ID

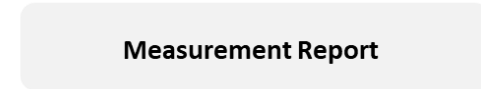

Ec/NO

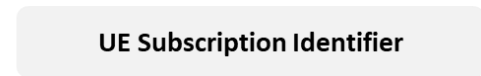

RNC ID



UE Context

PROPAGATION MODELLING AND GEO-LOCATION

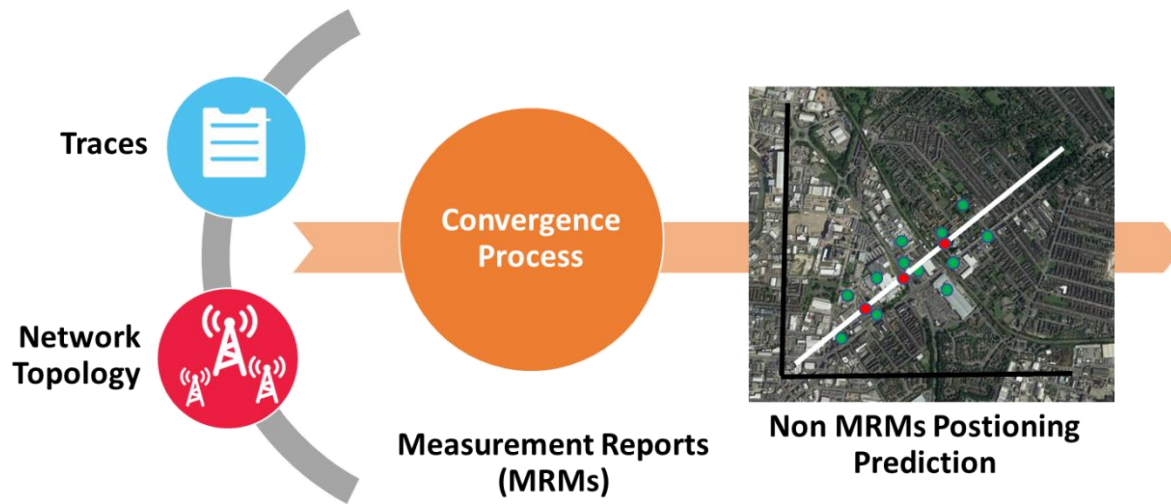

Positioning Error	
Mean Error [m]	Median Error [m]
220	180

• Geolocation OTD

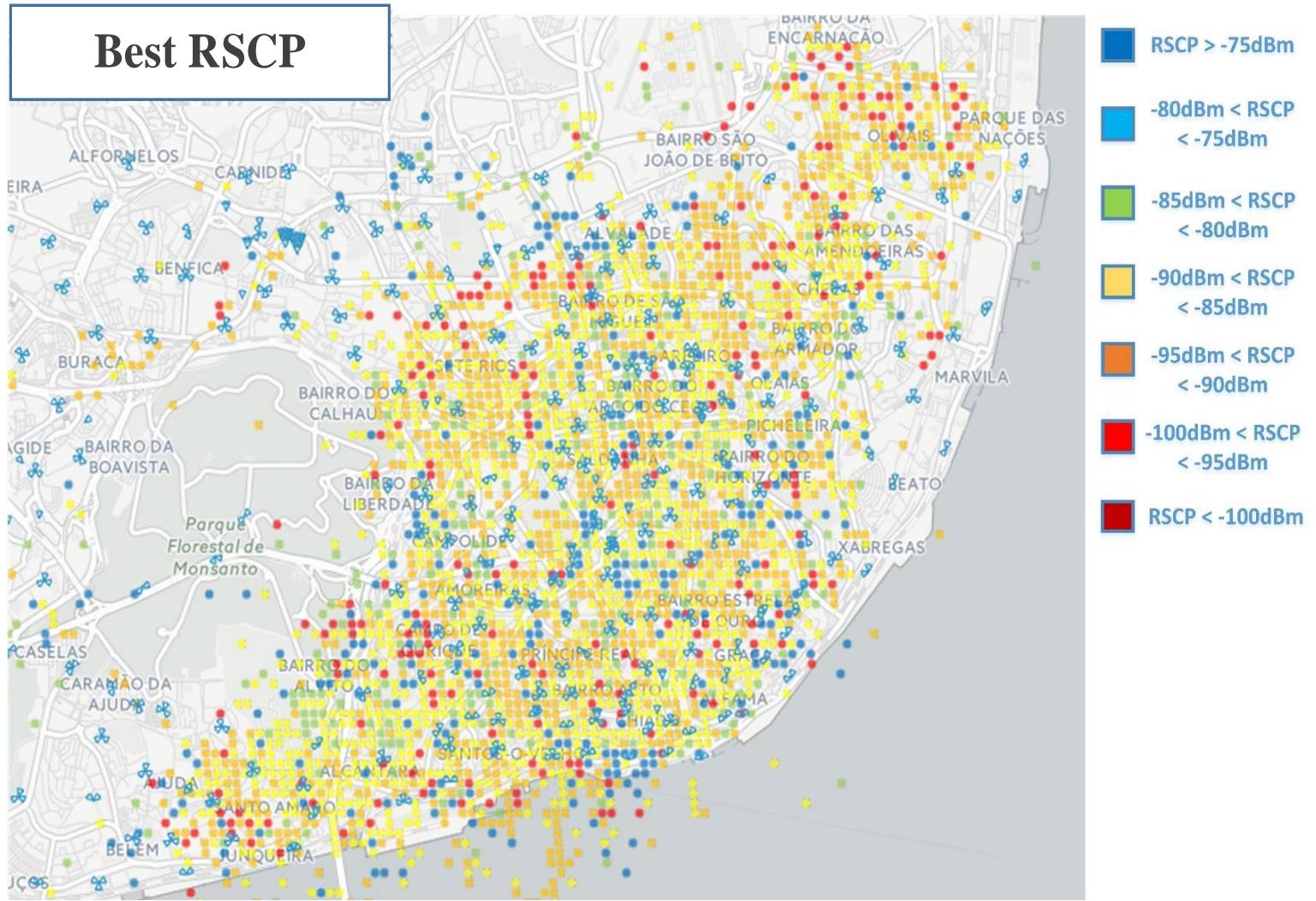

- Geolocation OTD

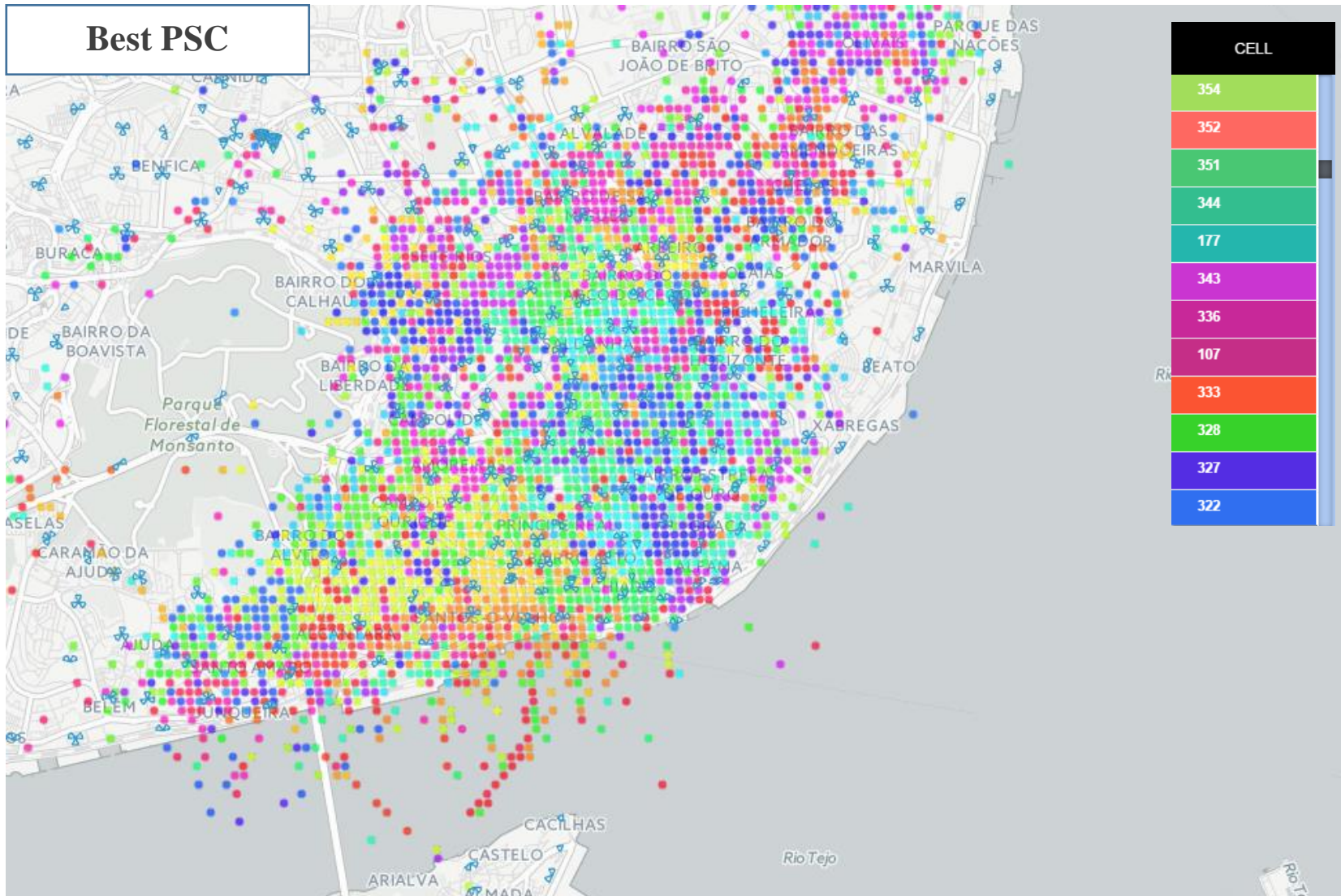

- **Geolocation OTD Validation through RSCP**

Park José Gomes Ferreira, Lisbon

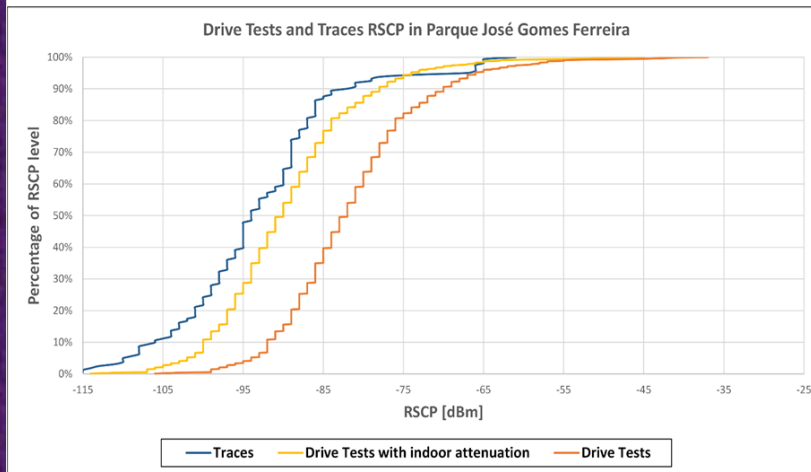

- Median RSCP absolute error: 5 dB

Jardim da Estrela (Star Garden), Lisbon

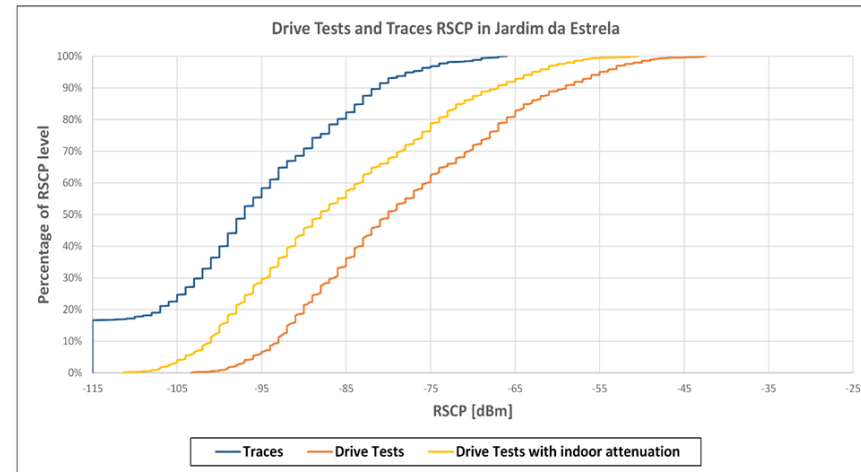

- Median RSCP absolute error: 7 dB

5G



Pedro Vieira



ISEL
INSTITUTO SUPERIOR DE
ENGENHARIA DE LISBOA

it instituto de
telecomunicações

CELFINET
outstanding networks

MOBILE NETWORKS EVOLUTION

- Roughly every ten years, a new generation has emerged to fulfil different needs from users and industries. For example, the main difference between 2G and 3G is the access to mobile data services.
- The next step will be 5G that will impact society more than any of its predecessors. There are several key trends that show a need for a new network – increase of the number of subscriptions and the mobile data traffic generated by each user will also increase

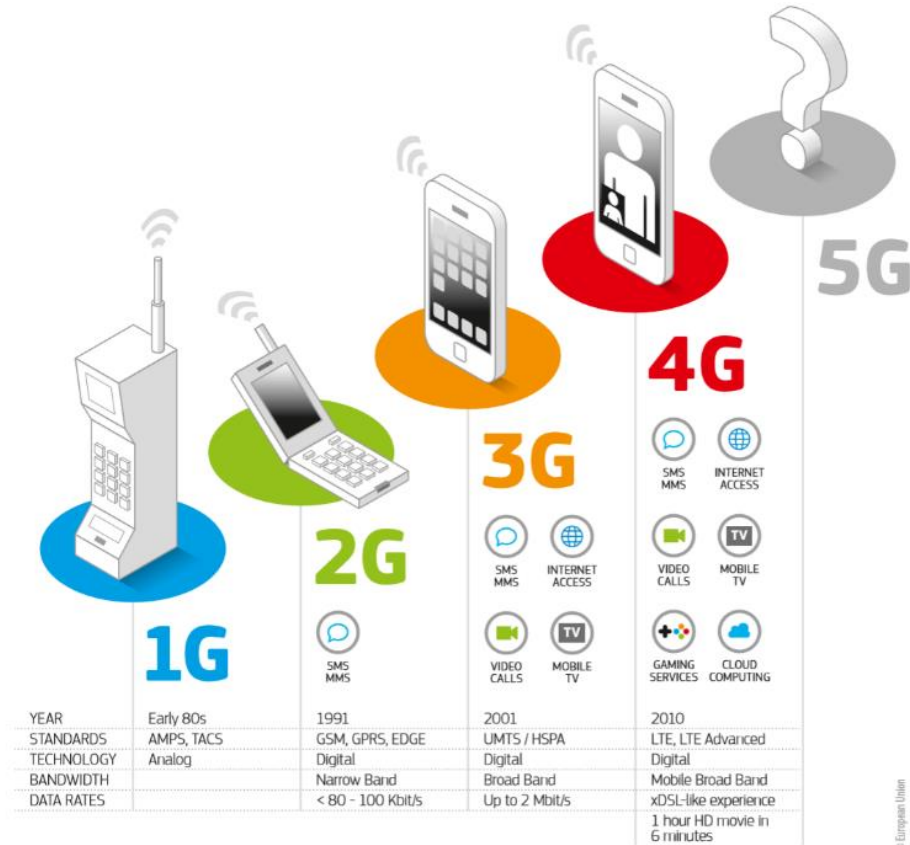

- This is due mainly to video content, that is predicted to grow 35% annually through 2024

- eMBB focuses on services requiring high data rates across a wide coverage area such as 4K video streaming, AR and VR

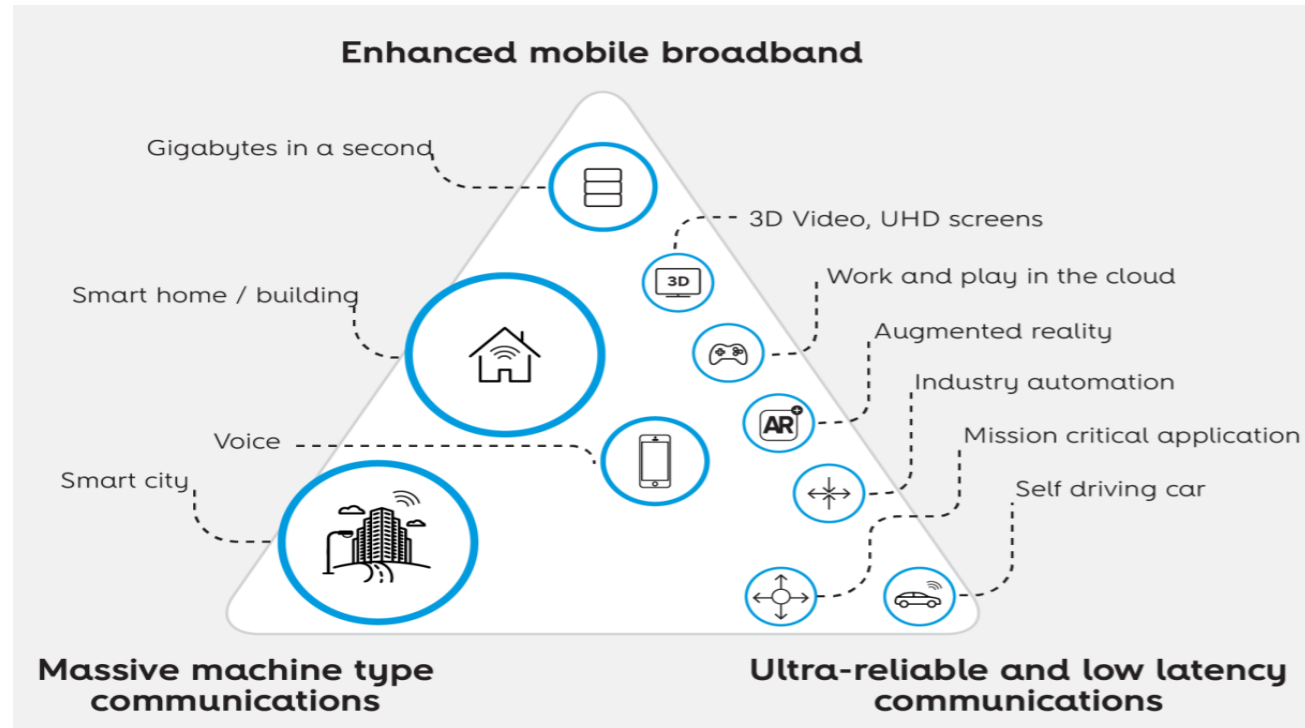

- mMTC services require a high connection density and energy efficiency. This is the use case responsible for industry 4.0 and smart cities, dependent on high number of sensors which have to be optimized to consume low energy.
- URLLC requires very low latency and a reliable network in order to ensure critical services such as autonomous vehicles and remote healthcare.

REQUIREMENTS

- eMBB will most likely be the first use case deployed in the 5G network. It can be seen that eMBB presents a wide range of requirements compared to the others while the others have very specific requirements.

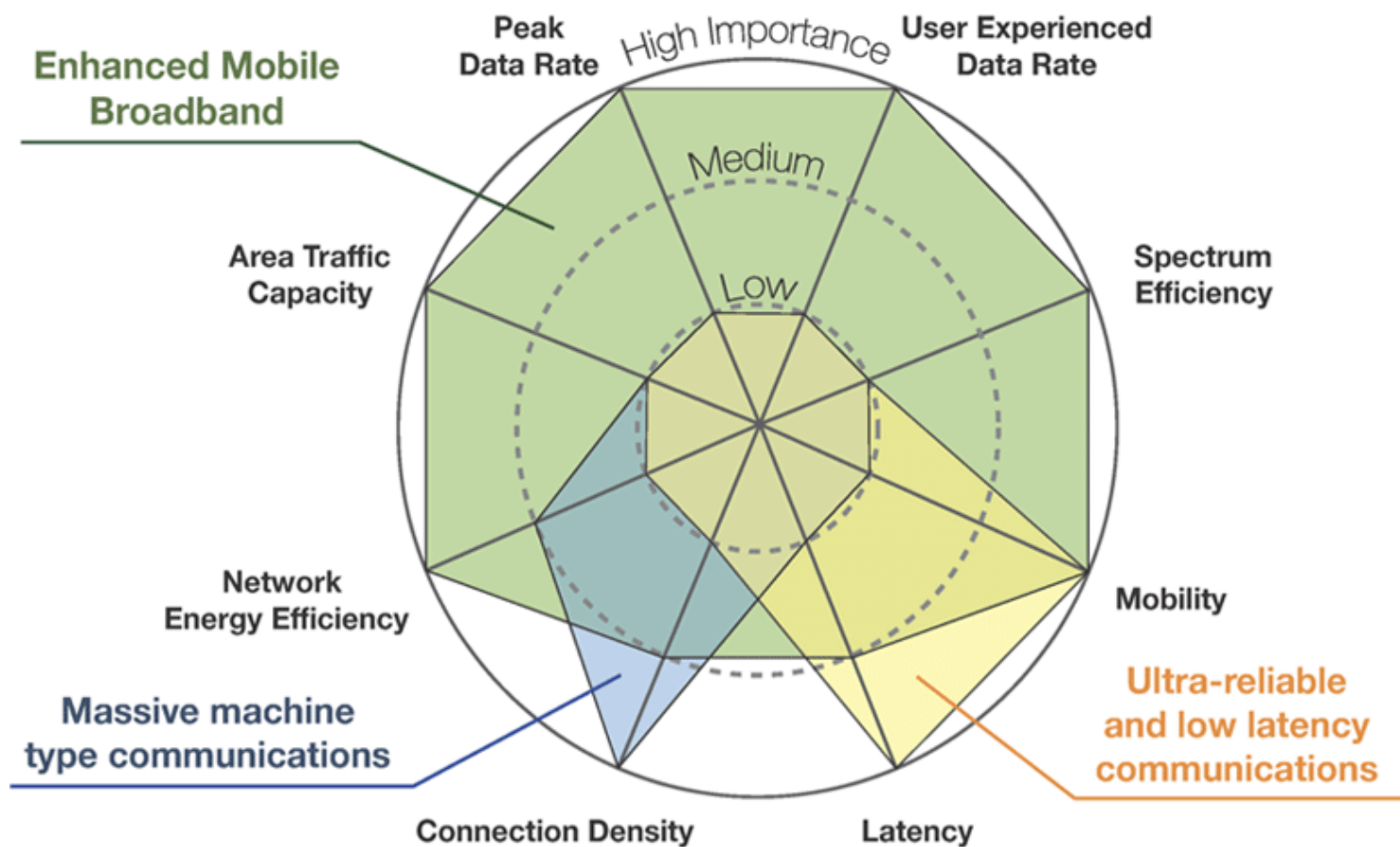

- Operators to choose the deployment they consider most advantageous.
- High frequencies provide higher data rates but have smaller distances and low frequencies provide a wide coverage area but better propagation characteristics. This means that high frequencies will likely be used for high density hotspots and low frequencies will be used for rural coverage.
- This technology contributes to more reliable high speed connections and can often be combined with beamforming to serve more users.

1

New architecture

allows the integration of elements of different generations in different configurations, namely Standalone (SA) and Non-Standalone (NSA).

2

Spectrum

will expand the range of frequencies used for mobile communication. 5G radio will benefit from all spectrum options between 400 MHz and 90 GHz.

3

Massive MIMO

employs the use of a large number of antenna elements to improve both throughput and energy efficiency.

Cloud Radio Access Network

Is a combination of distributed and centralized deployments which takes advantage of the strengths of centralization and implements a more affordable fronthaul solution.

Multi-Access Edge Computing

is the technology to move the execution applications closer to the users. This will enable improve latency, reliability and efficiency of the network.

Network Slicing

is a technology that allows an operator to deploy multiple logical networks over the same physical infrastructure.

4

5

6

1

Large Continuous Unused Bandwidth

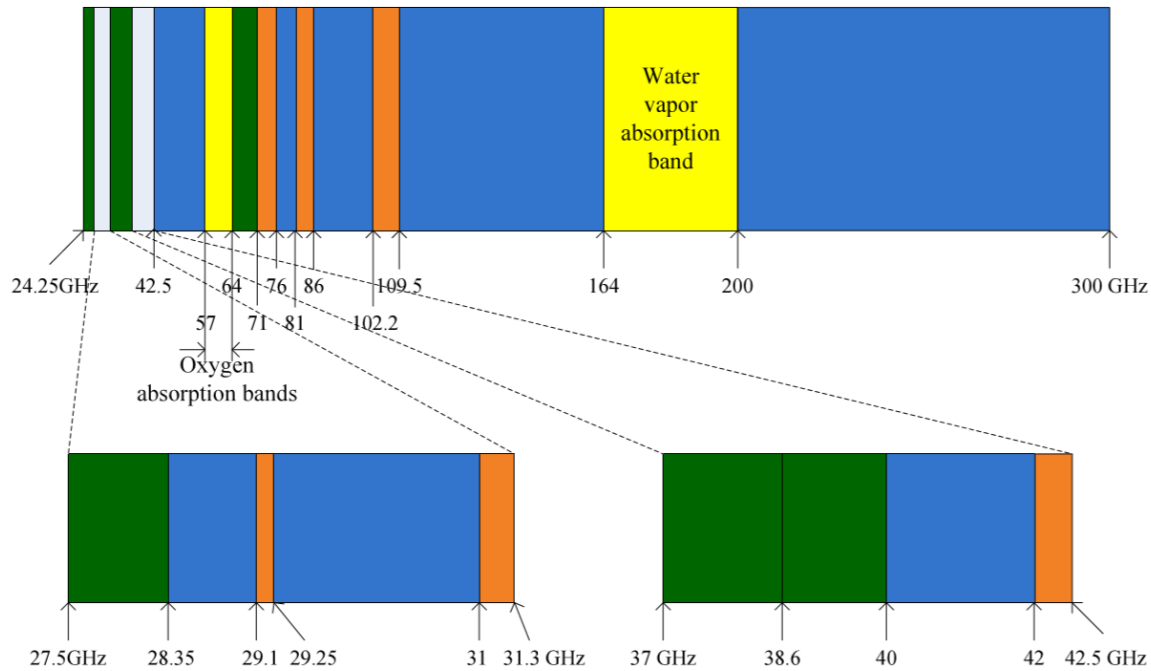

2

Narrow Beamwidth

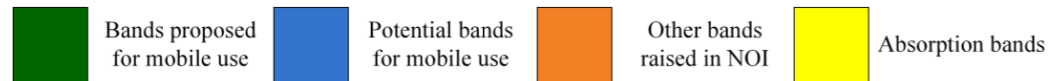

- 780 MHz in microwave vs. 150 GHz in mmWave – gbps speeds to multiple devices
- Smaller wavelengths – mMIMO beamforming - stronger radio signal and throughput for greater distances – better link performance - low interference

1

Pathloss and Penetration Loss

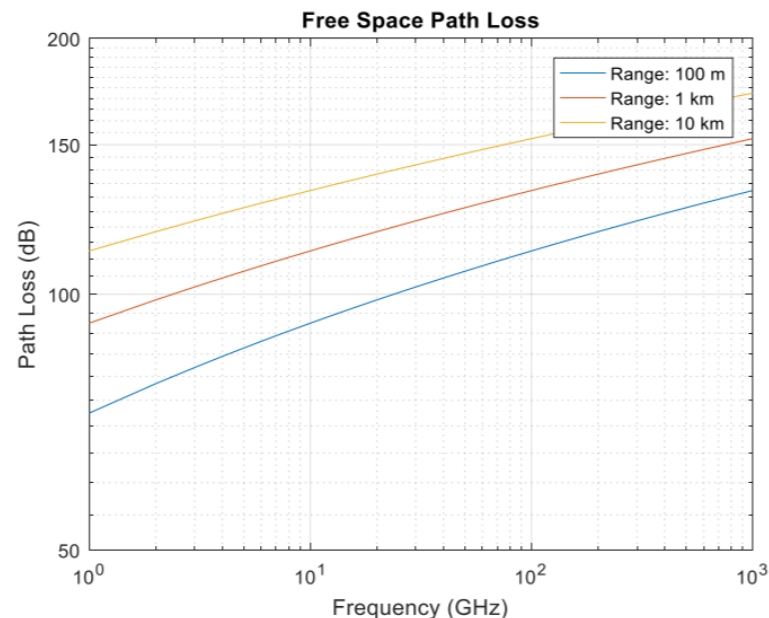
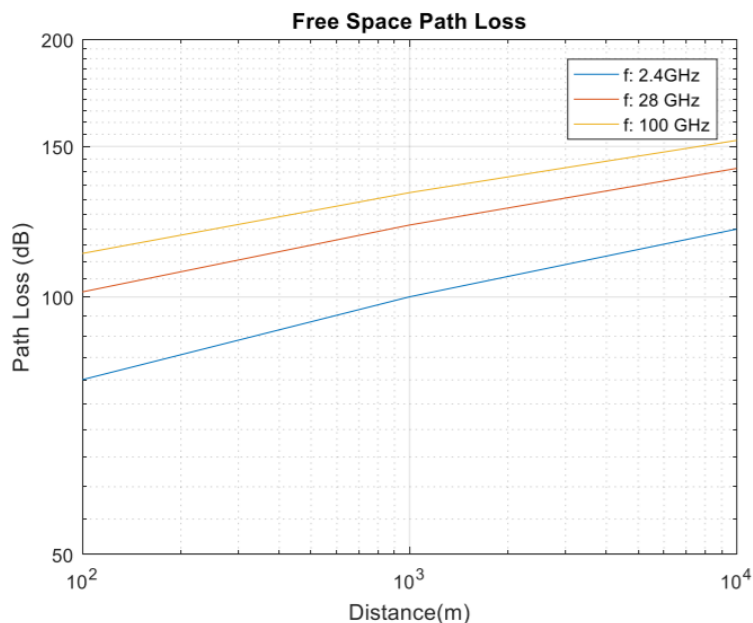

- Bad for long distances – directive antennas in clean air conditions. But atmosphere interferes.
- LoS also affects mmWave propagation. The pathloss exponent is much higher for NLoS, making it very difficult to use mmWave to cover indoor environments using nodes deployed outside or vice-versa

2

Propagation Loss (due to rain)

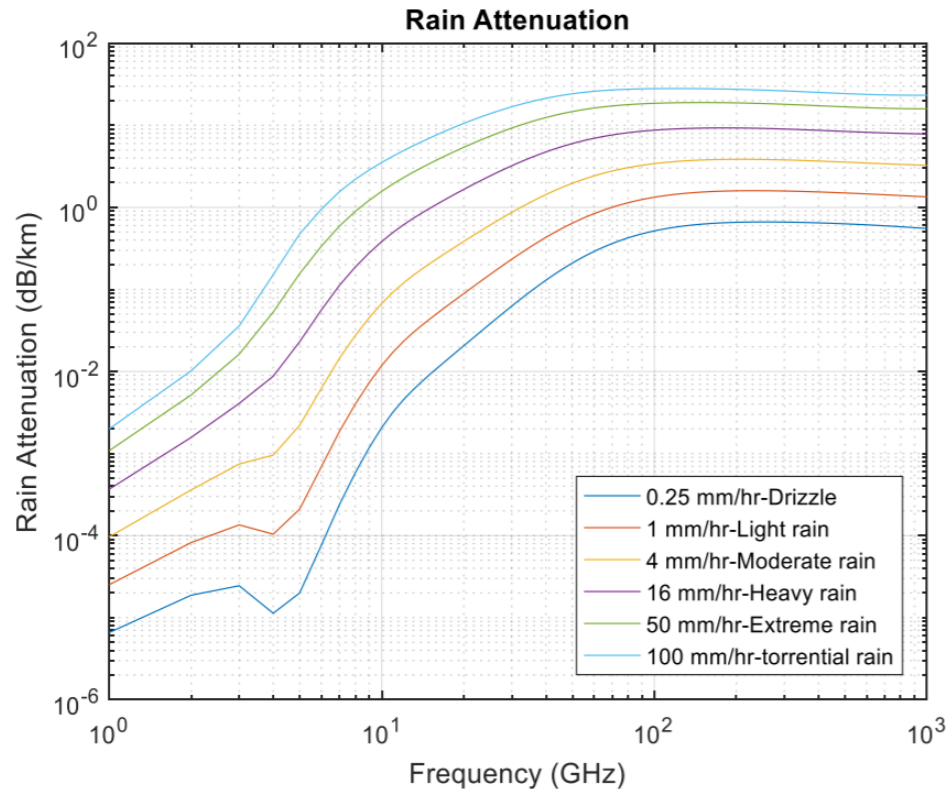

- Bad for long distances – directive antennas in clean air conditions. But atmosphere interferes.
- LoS also affects mmWave propagation. The pathloss exponent is much higher for NLoS, making it very difficult to use mmWave to cover indoor environments using nodes deployed outside or vice-versa

2

Propagation Loss (due to fog)

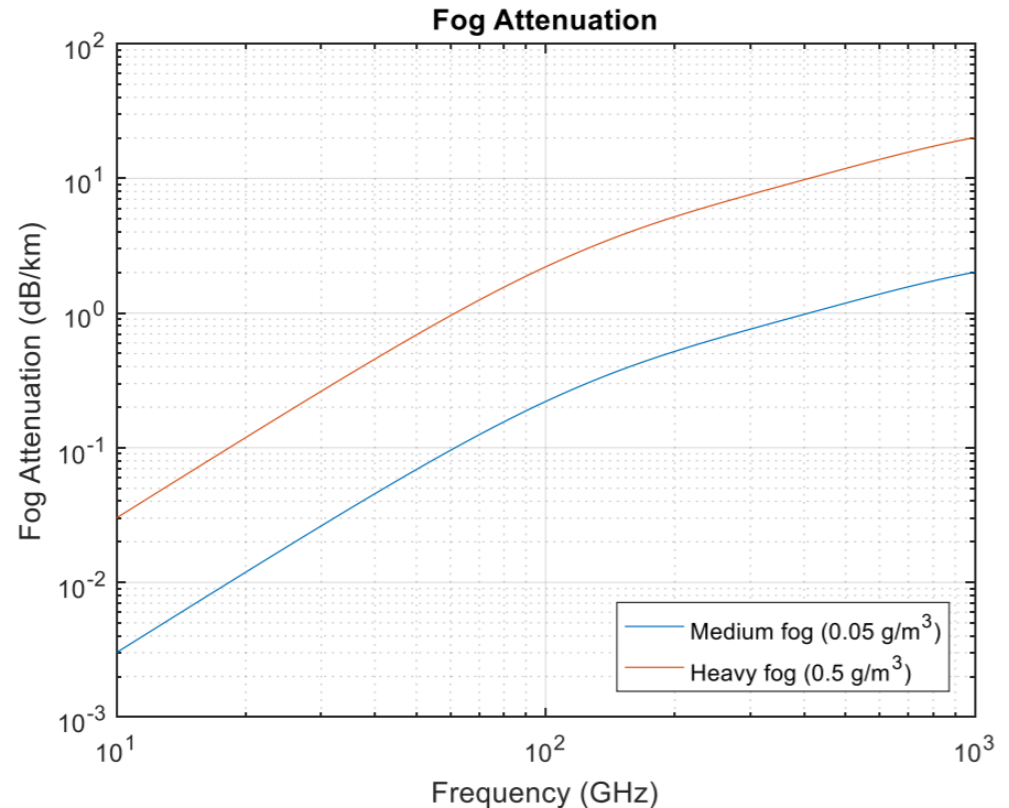

- Bad for long distances – directive antennas in clean air conditions. But atmosphere interferes.
- LoS also affects mmWave propagation. The pathloss exponent is much higher for NLoS, making it very difficult to use mmWave to cover indoor environments using nodes deployed outside or vice-versa

2

Propagation Loss (due to Atmospheric Gases)

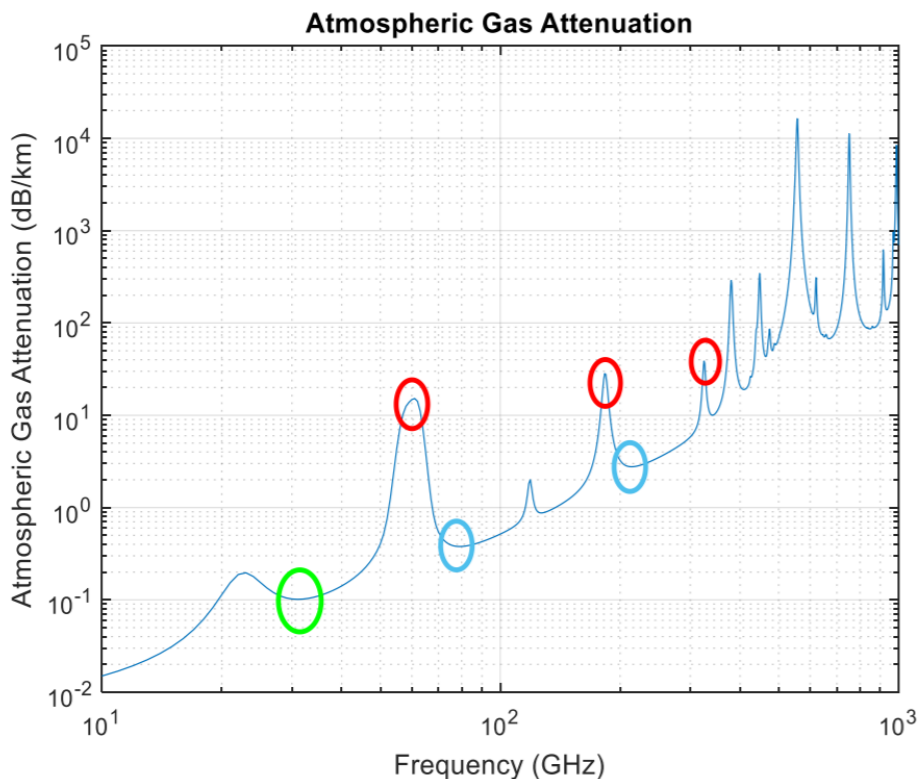

- Bad for long distances – directive antennas in clean air conditions. But atmosphere interferes.
- LoS also affects mmWave propagation. The pathloss exponent is much higher for NLoS, making it very difficult to use mmWave to cover indoor environments using nodes deployed outside or vice-versa

3

Sensitivity to Blockage

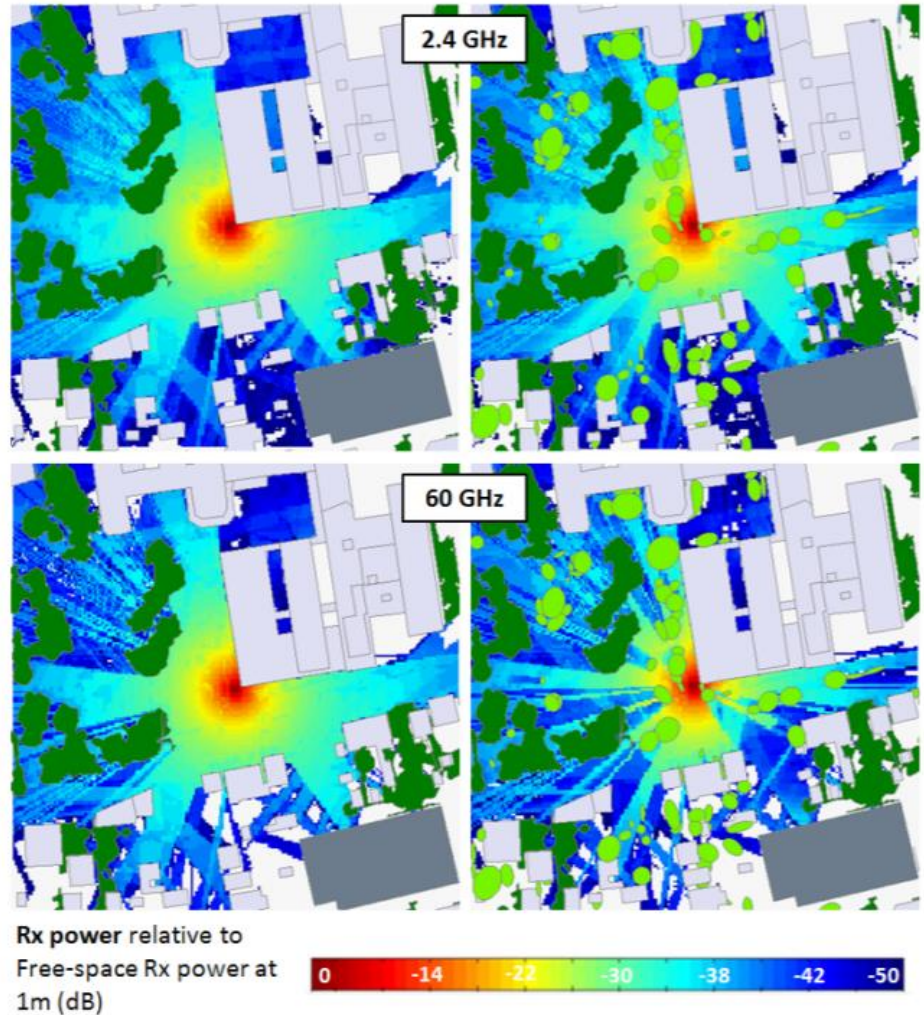

- Ability to diffract depends on wavelength.
- Intermittent connection – not reliable

- Massive MIMO beamforming will contribute to a better end user experience by boosting mobile network performance.



Advantages

- Higher spectral efficiency
 - Improved antenna gain
 - Better link performance
 - Wider coverage area
 - Limited interference
- Gain values depend on number of antennas

DEPLOYMENT OPTIONS

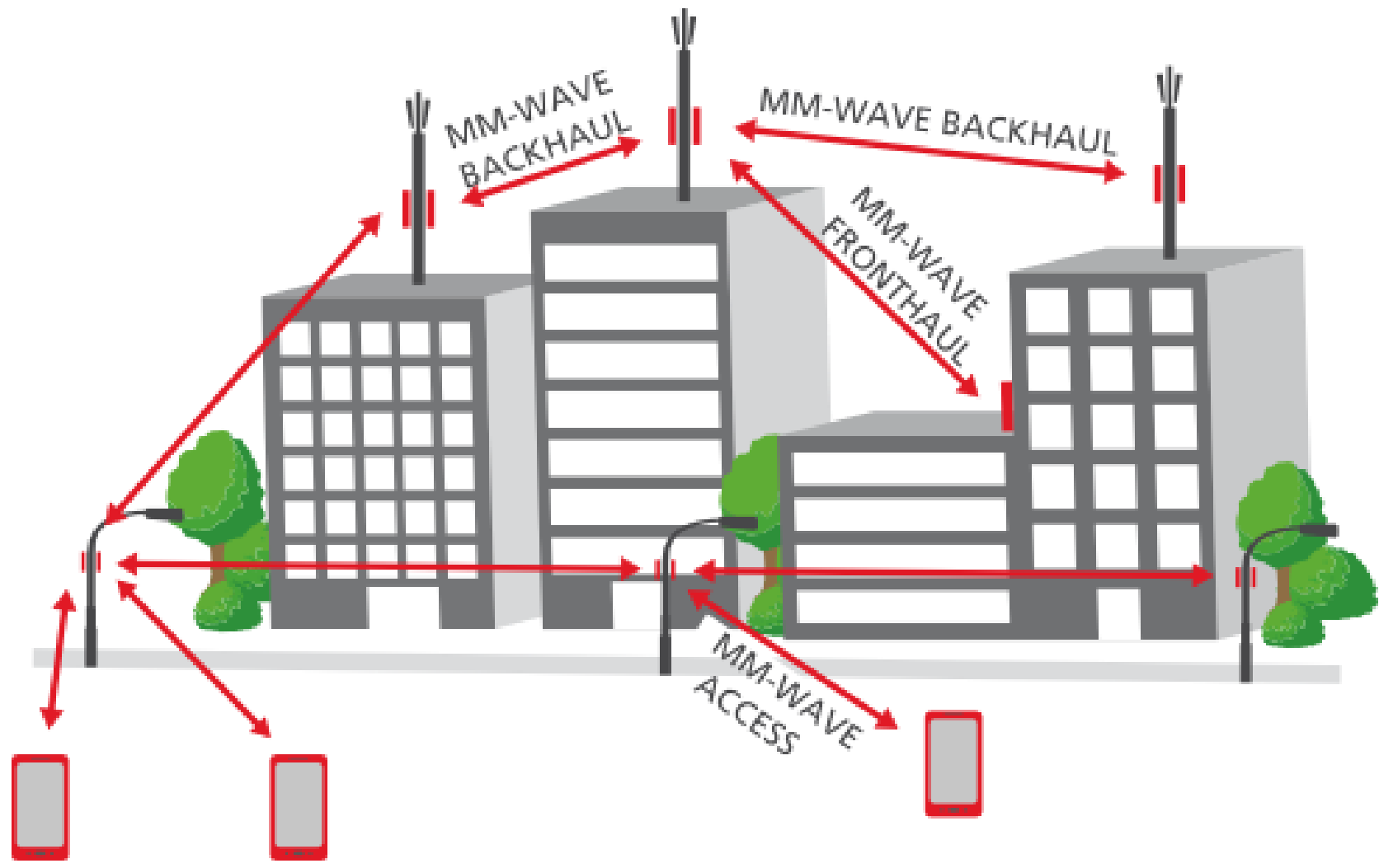

Expected 5G Frequency Band Usage

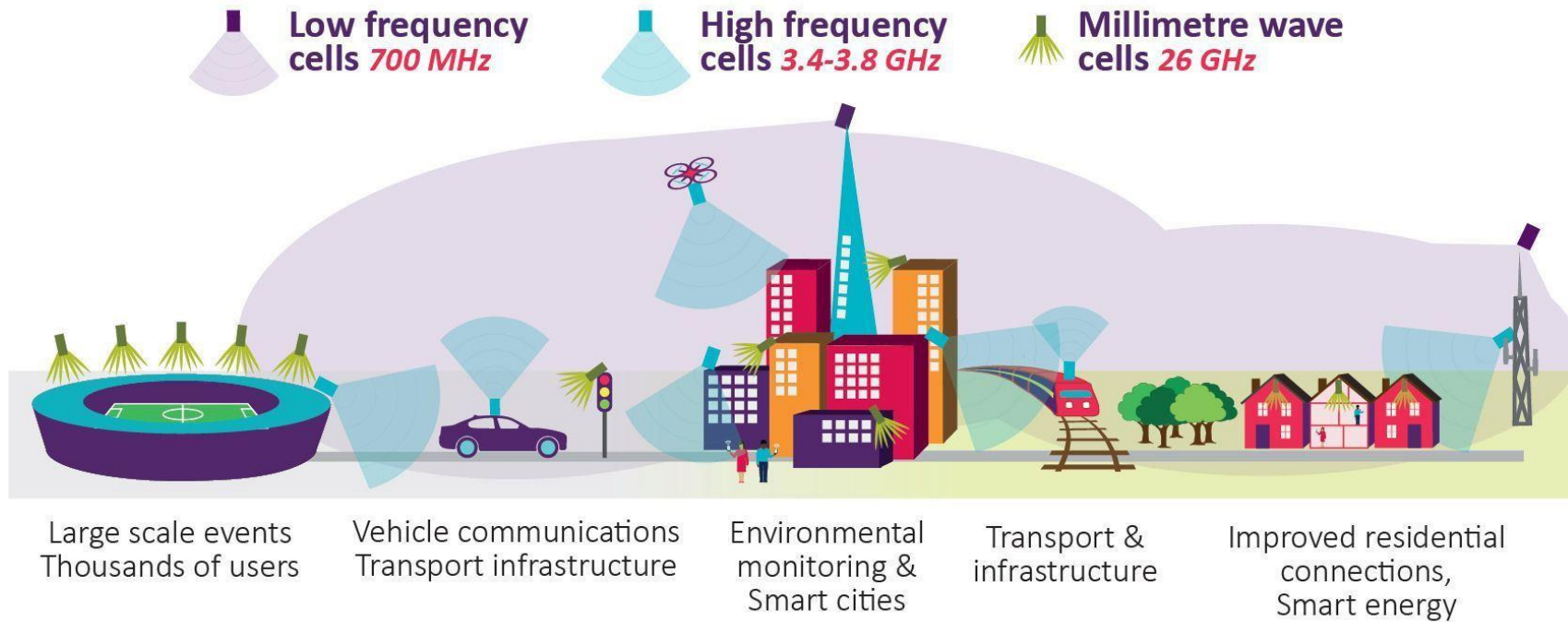

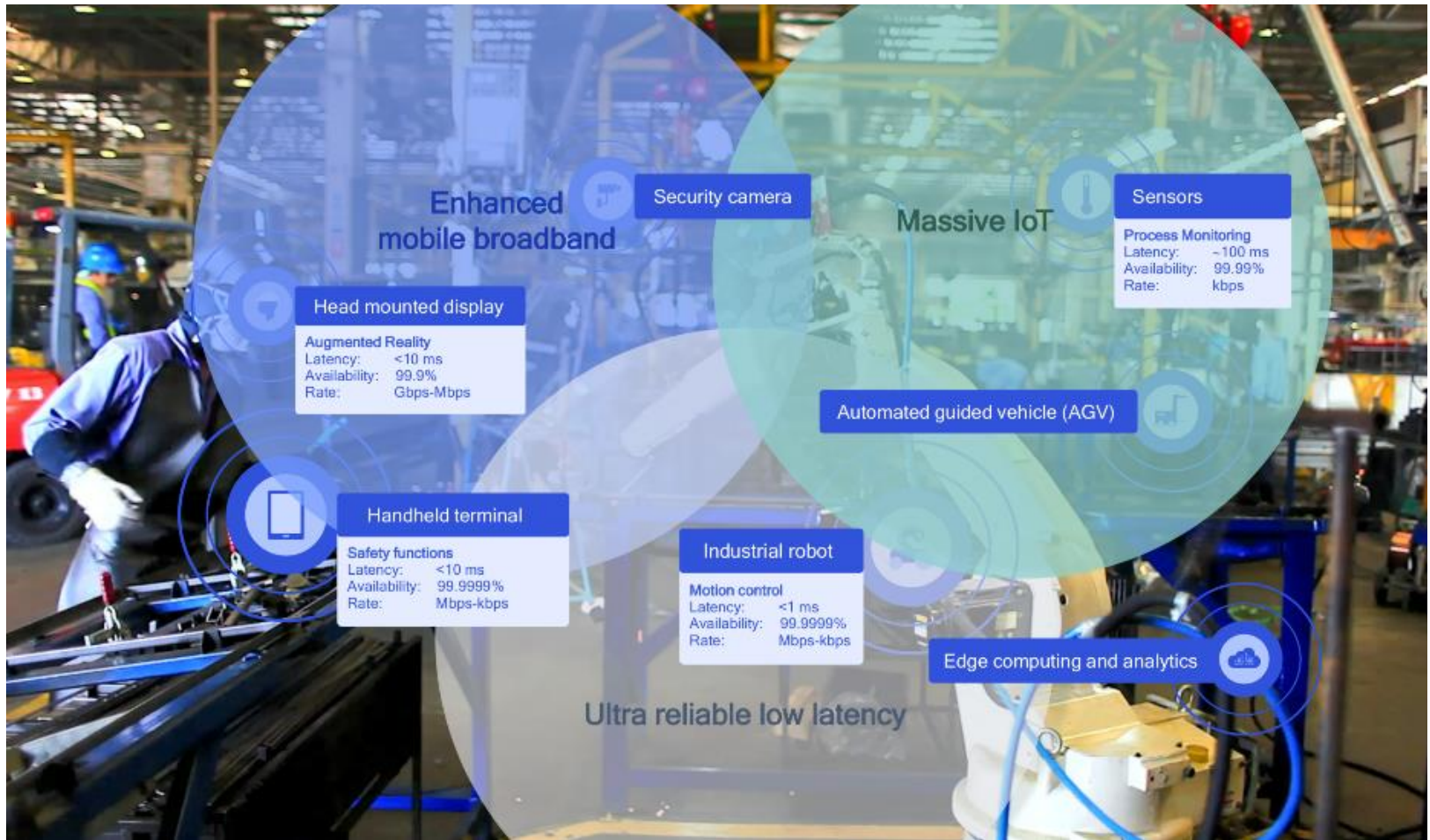

Source: Qualcomm

UPGRADING EXISTENT INDUSTRIAL NETWORKS WITH

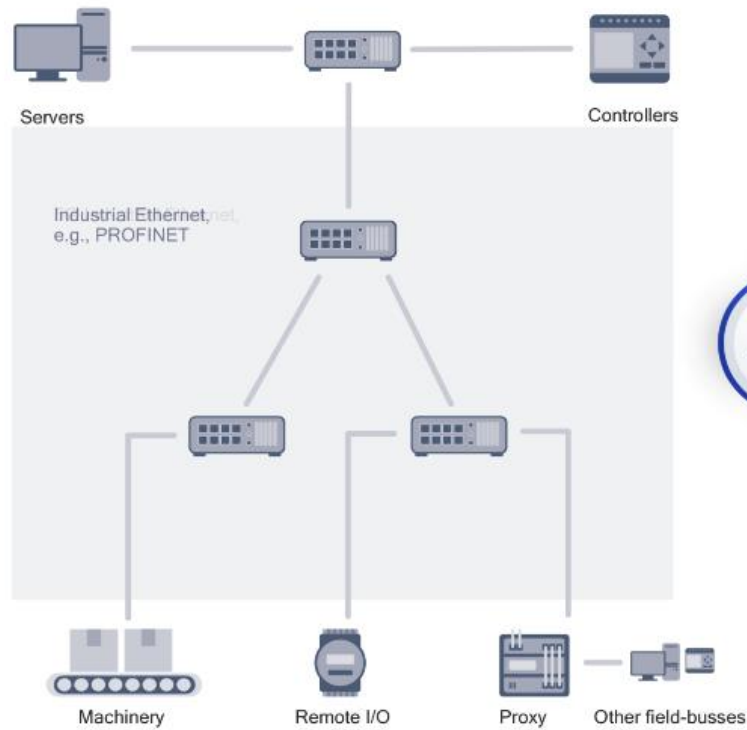

5G

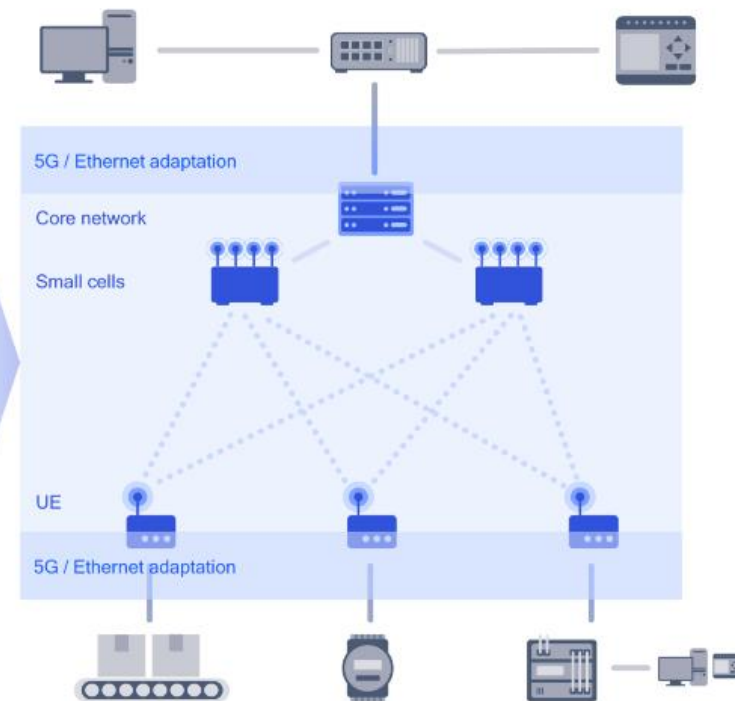

Source: Qualcomm

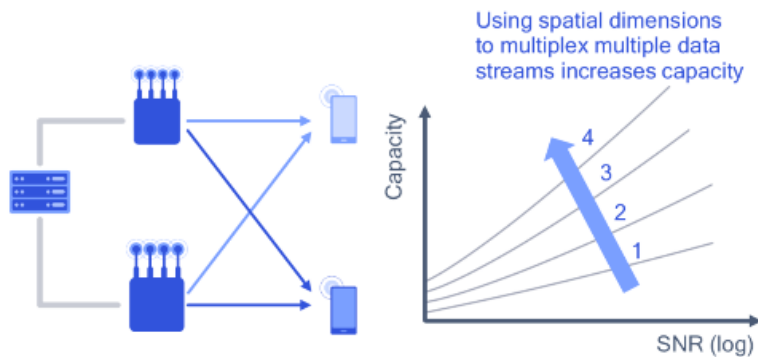

Capacity from spatial multiplexing

Allows multiple transmissions at the same time to multiple location without interfering

Can also be used to by multiple operators to share spectrum more efficiently

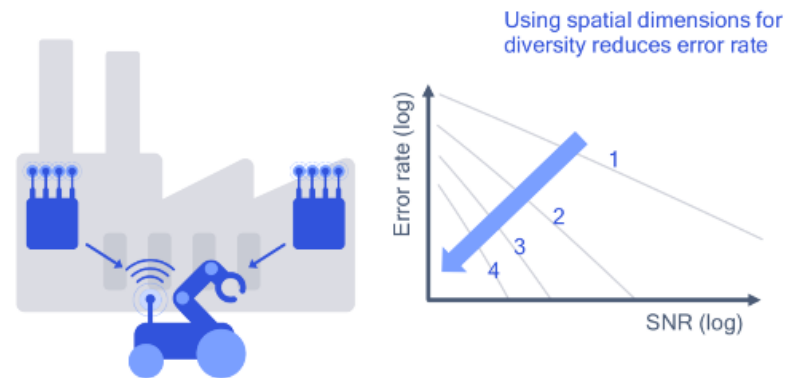

Reliability from spatial diversity

Spatial diversity can overcome radio shadowing in challenging radio environments

Key for URLLC¹ to meet 99.9999% reliability and challenging industrial IoT applications

Source: Qualcomm

5G Technology Features

- Low latency
- Ultra-high reliability
- High bandwidth
- Massive number of devices
- Support of new frequencies

5G Small Cell Deployment

- In licensed bands give predictable performance
- Easy-to-install and self organising
- Small cells ideal for site-specific deployments (outdoor, indoor, below ground)

Service Features

- Deployed as a service
- Easy to integrate into corporate and mobile networks
- Mobile network offload

Source: Dense Air

Smart Logistics using AGVs requires Reliable Wireless

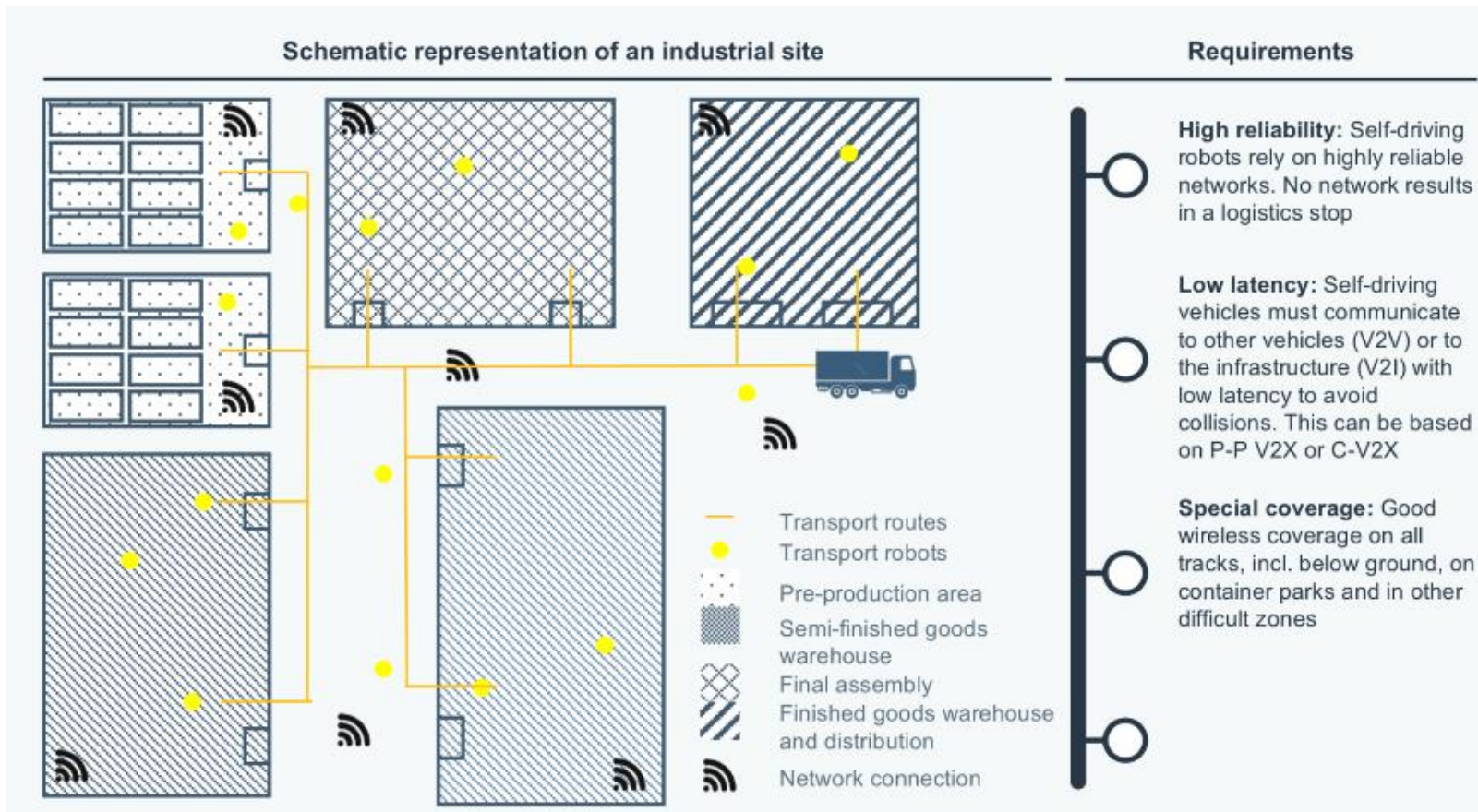

Source: Dense Air

5G AS A GLOBAL ECONOMIC CORNERSTONE



>\$5 Trillion¹

Global economic output in 2035 enabled by 5G in the following five categories



Manufacturing
\$3,364B



Transport
\$659B



Construction
\$742B



Utilities
\$273B



Mining
\$249B

1. "The 5G economy: How 5G technology will contribute to the global economy" by IHS Economics / IHS Technology

Source: Qualcomm

mv@isel.ipl.pt

Thank
YOU



Goodbye & good luck

