



# **Cognitive Technologies in 5G Slicing Management and Control**

**Eugen Borcoci**  
**University Politehnica Bucharest**  
**Electronics, Telecommunications and Information Technology Faculty**  
**( ETTI)**  
Eugen.Borcoci@elcom.pub.ro

InfoWare 2019 Conference, June 30 - July 04, Rome



# Cognitive Technologies in 5G Slicing Management and Control



## ■ Acknowledgement

- This overview and analysis is compiled and structured, based on several **public documents** like: conferences material, studies, research papers, standards, projects, overviews, tutorials, etc. (see specific references in the text and Reference list).
- The selection and structuring of the material belongs to the author.
- **Notes:**
  - Given the extension of the topics, this presentation is limited to a high level overview only, mainly on architectural aspects
  - **The presentation is not an in-depth overview of the cognitive/artificial intelligence topics but it basically try to show how such techniques are useful in 5G M&C**



# Cognitive Technologies in 5G Slicing Management and Control



## ■ Motivation of this talk

- **The 5G (fifth generation):** new generation of mobile networks offering a large range of services to satisfy various customer demands
- Different from **4G concept: “one-fit-all”**, 5G supports
  - dedicated, separated - **logical slices**
  - **customization for various business demands with different requirements**
  - programmability through softwarization, open sources and open interfaces that allow access for third parties
- **Driving forces for 5G:** IoT, smart cities, industry, governance, loV/automotive, safety/emergency, entertainment, environment, etc.
- Many **R&D projects** related to different areas of 5G
- **Standardization**/forums organizations and projects are involved
  - NGNM, 3GPP, 5GPPP, ETSI, ITU-T, GSMA, BBF, ONF, IETF, IEEE, many int'l and European projects



# Cognitive Technologies in 5G Slicing Management and Control



## ■ Motivation of this talk (cont'd)

- **5G Network slicing** – resource sharing (w. logical isolation) among multiple tenants and/or network operators in multi-domain context
- 5G sliced networks: **multi-tenant, multi-domain, E2E, multi-provider/operator context** → many open research issues and challenges
- **5G slicing management and control (M&C) aspects**
  - Service/data model & mapping on slices
  - Customized slice design and preparation, stitching / composition in a single domain and cross-domain
  - Network slice life cycle management, monitoring and updating
- **M&C system: should react in real-time, based on complex decision making techniques, that analyse historical, temporal and frequency network data**
  - **Cognitive network management technologies added to M&C, allows : self-aware, self-configuring, self-optimization, self-healing and self-protecting characteristics**
  - **Generally, self – organizing – networks (SON) capabilities can be achieved**

InfoWare 2019 Conference, June 30 - July 04, Rome



# CONTENTS

---



1. Introduction
2. 5G slicing relevant architectures
3. Management, orchestration and control
4. Cognitive technologies in 5G slicing M&C
5. Conclusions and research challenges



# CONTENTS



1. **➔ Introduction**
2. 5G slicing relevant architectures
3. Management, orchestration and control
4. Cognitive technologies in 5G slicing M&C
5. Conclusions and research challenges



# 1. Introduction



## 1.1 5G general aspects

- **Three views/sets-of-requirements for 5G**
  - *user-centric, service-provider-centric, network-operator-centric*
- **5G Key technological characteristics**
  - Integrates different and heterogeneous access technologies, cellular, **Radio Access Technologies (RAT)**, satellites, ..
  - Ultra-dense networks with numerous small cells
  - **Driven by SW**
    - unified OS in a number of PoPs, especially placed at the network edge
  - Complementary technologies for 5G slicing
    - **Software Defined Networking (SDN)**
    - **Network Functions Virtualization (NFV)**
    - **Cloud/Mobile Edge Computing (MEC) /Fog Computing (FC)**
  - **Recent trends: Optimized and advanced M&C**
    - **cognitive features, autonomic management**
    - **advanced automation** of operation through proper algorithms
    - Data Analytics and Big Data techniques -> monitor the users' QoE



# 1. Introduction



## 1.1 5G general aspects

- **Network softwarization**
  - **programmability** of network devices
  - **network functions (NF)**- virtual or physical
  - **network slices** – logical, on demand, customized networks
  - **architectural planes**: data/user, control, management
  - softwarization capabilities in all network segments and network components
  
- **Separation** of concerns between
  - control/ management/ services
  - logical / physical resources functions (in terms of connectivity, computing and storage)
  
- **On demand composition** of NFs and network capabilities

*See: A.Galis, 5G Architecture Viewpoints H2020 5G PPP Infrastructure Association July 2016, August 2017, <https://5g-ppp.eu/white-papers/>*

**InfoWare 2019 Conference, June 30 - July 04, Rome**





# 1. Introduction



## 1.2 5G Key Specific Requirements

- **Summary of 5G figures - strong goals**
  - **1,000 X in mobile data volume** per geographical area reaching a target  $\geq 10$  Tb/s/km<sup>2</sup>
  - **1,000 X in number of connected devices** reaching a density  $\geq 1$  M terminals/km<sup>2</sup>
  - **100 X in user data rate** reaching a peak terminal data rate  $\geq 10$  Gb/s
  - **1/10 X in energy** consumption compared to 2010
  - **1/5 X in E2E latency reaching 5 ms** for e.g. tactile Internet and radio link latency reaching a target  $\leq 1$  ms, e.g. for Vehicle to Vehicle (V2V) communication
  - **1/5 X in network management OPEX**
  - **1/1,000 X in service** deployment time, reaching a complete deployment in  $\leq 90$  minutes

InfoWare 2019 Conference, June 30 - July 04, Rome

## 1.3 5G Generic Architecture

- multi-tier architecture: small-cells, mobile small-cells, D2D- and Cognitive Radio Network (CRN)

DR-OC - Device relaying with operator controlled link establishment

DC-OC - Direct D2D communication with operator controlled link establishment

DR-DC - Device relaying with device controlled link establishment

DC-DC - Direct D2D communication with device controlled link establishment

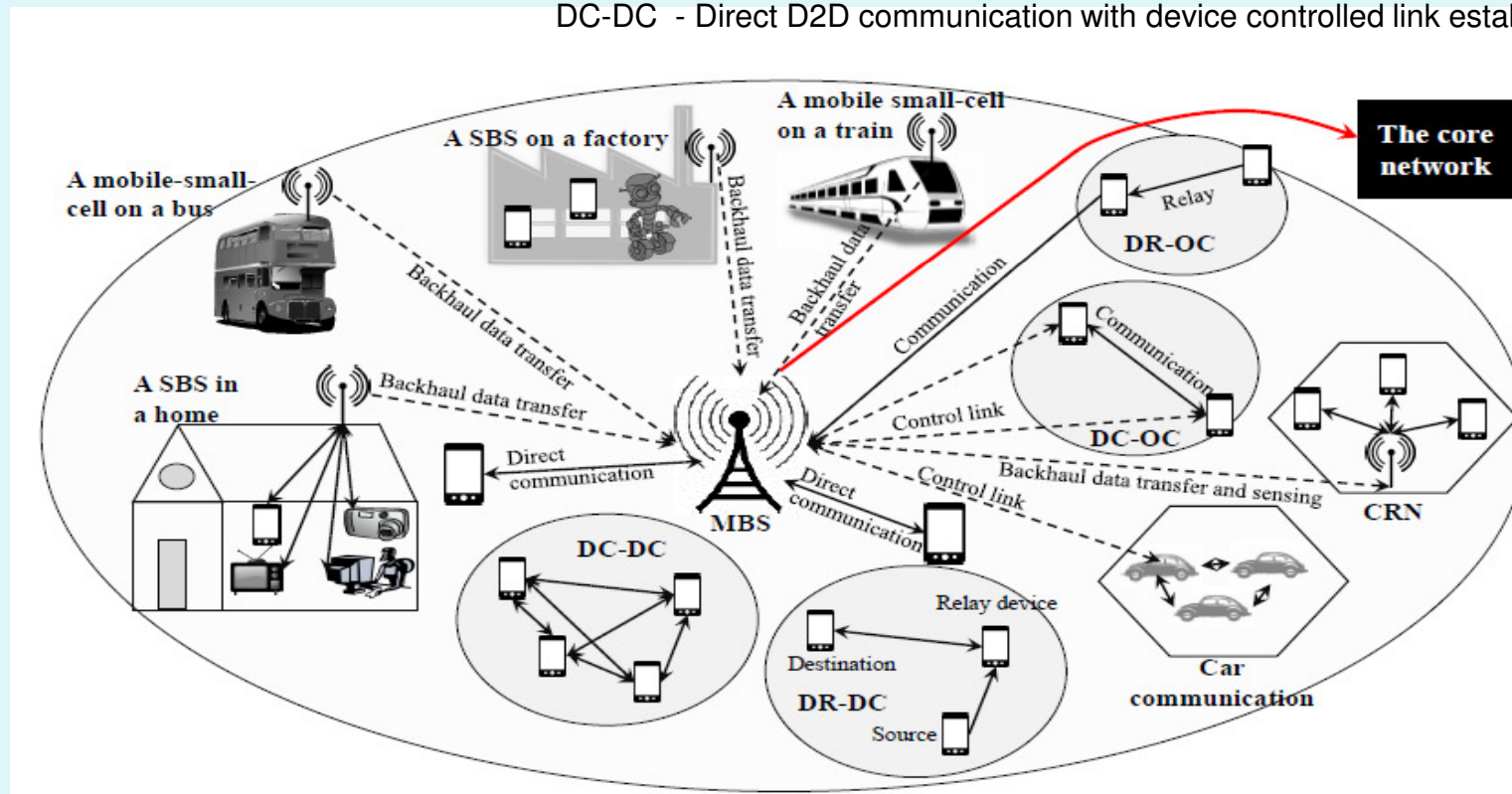

Source: Panwar N., Sharma S., Singh A. K. 'A Survey on 5G: The Next Generation of Mobile Communication'. Accepted in Elsevier Physical Communication, 4 Nov 2015, <http://arxiv.org/pdf/1511.01643v1.pdf>

## 1.4 4G versus 5G concepts

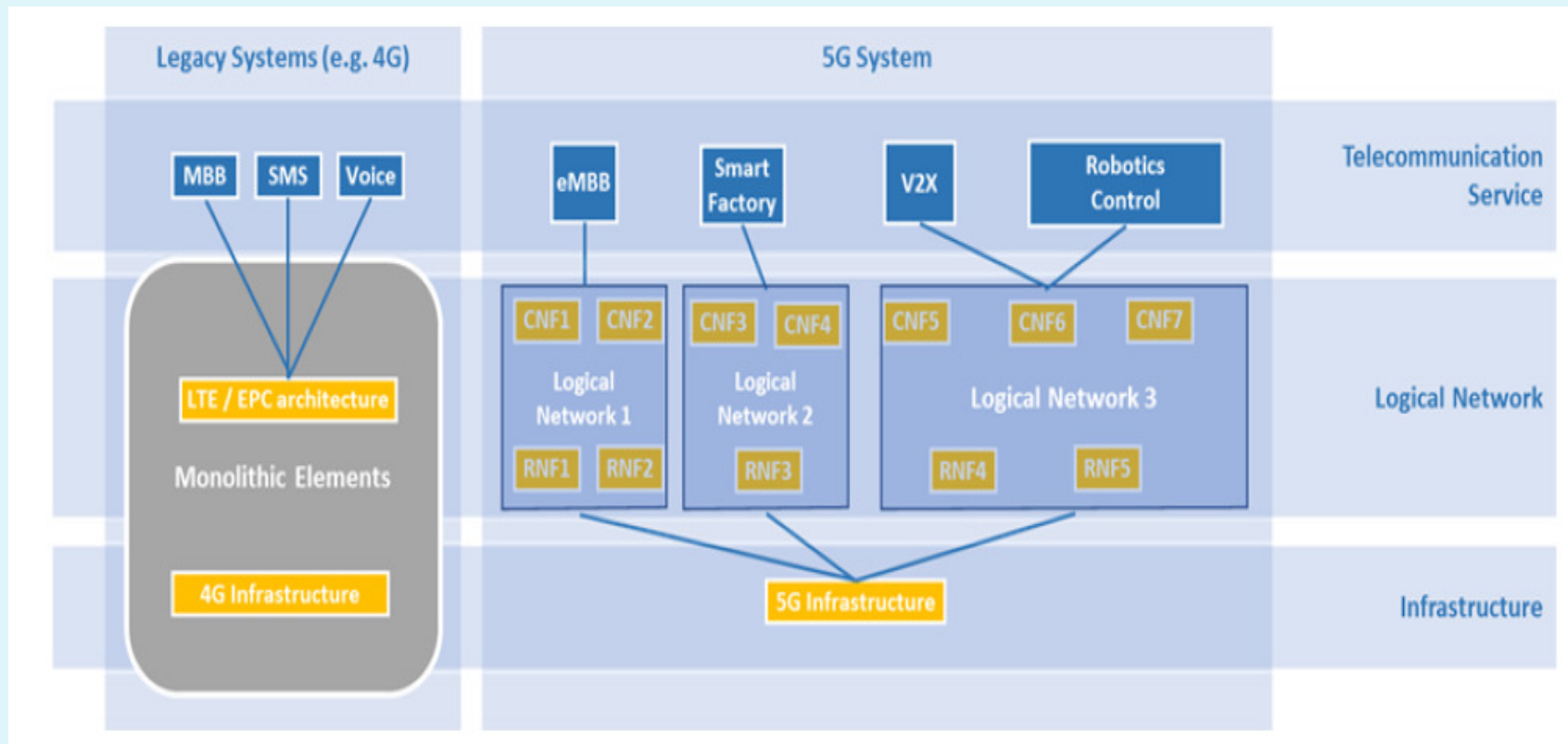

**MBB** - Mobile Broadband

**LTE** - Long Term Evolution (4G)

**V2X** - vehicle to X ; **CNF**- Core Network Functions

**SMS** - Short Messages service

**EPC**- Evolved Packet Core

**RNF**- RAN network Functions



# 1. Introduction



## 1.5 Network slicing concepts

- **E2E concept:** covering all network segments: radio, access/edge, wire, core, transport and edge networks.
- **concurrent deployment of multiple E2E logical, self-contained and independent shared or partitioned networks** on a common infrastructure
- **Slices**
  - created by **provisioning/ on\_demand**, isolated (w.r.t. performance, security), each one with its independent M&C
  - **composition** of adequately configured **NFs**, network apps., and the underlying cloud infrastructure (PHY/virtual/ emulated resources, etc.)
  - **resources are bundled together** to meet specific UC reqs. (e.g., bandwidth, latency, processing, resiliency) coupled with a business purpose
- **Complementary technologies**
  - **SDN, NFV:** virtualization, programmability, flexibility, modularity
  - **Cloud/Fog/Edge: processing**

## 1.5 Network slicing concepts (cont'd)

- 5G slicing generic example

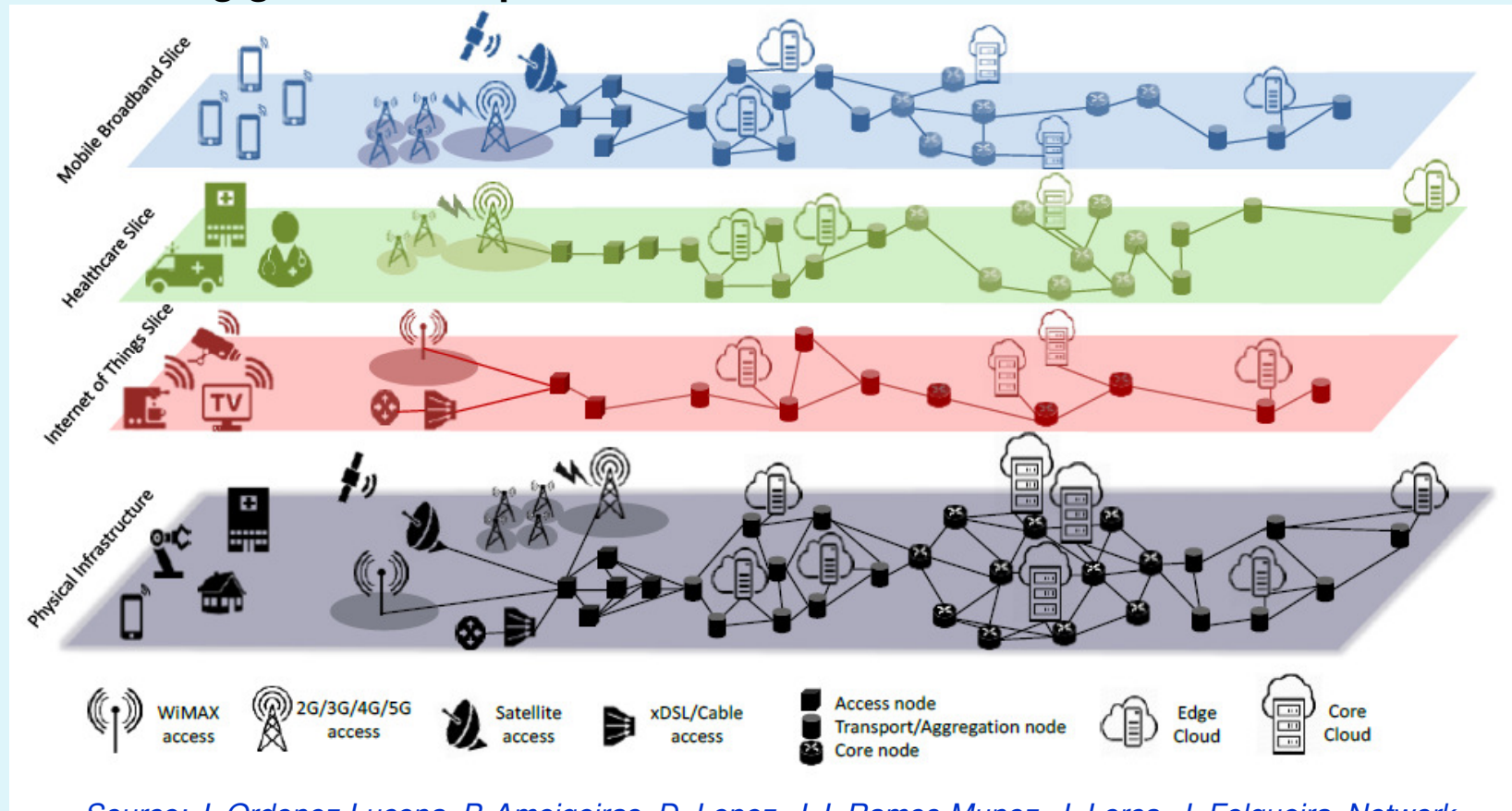

Source: J. Ordonez-Lucena, P. Ameigeiras, D. Lopez, J.J. Ramos-Munoz, J. Lorca, J. Folgueira, Network "Slicing for 5G with SDN/NFV: Concepts, Architectures and Challenges", IEEE Communications Magazine, 2017, Citation information: DOI 10.1109/MCOM.2017.1600935

InfoWare 2019 Conference, June 30 - July 04, Rome

## 1.5 Network slicing concepts (cont'd)

### UE Connection with the Network Slices

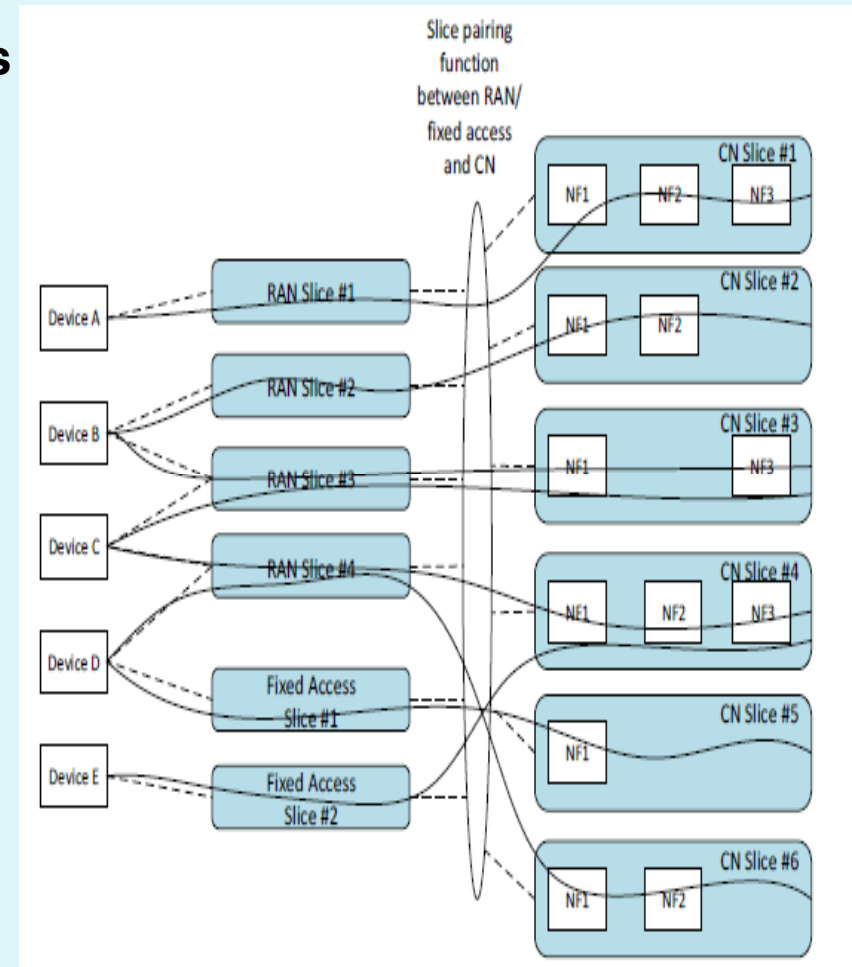
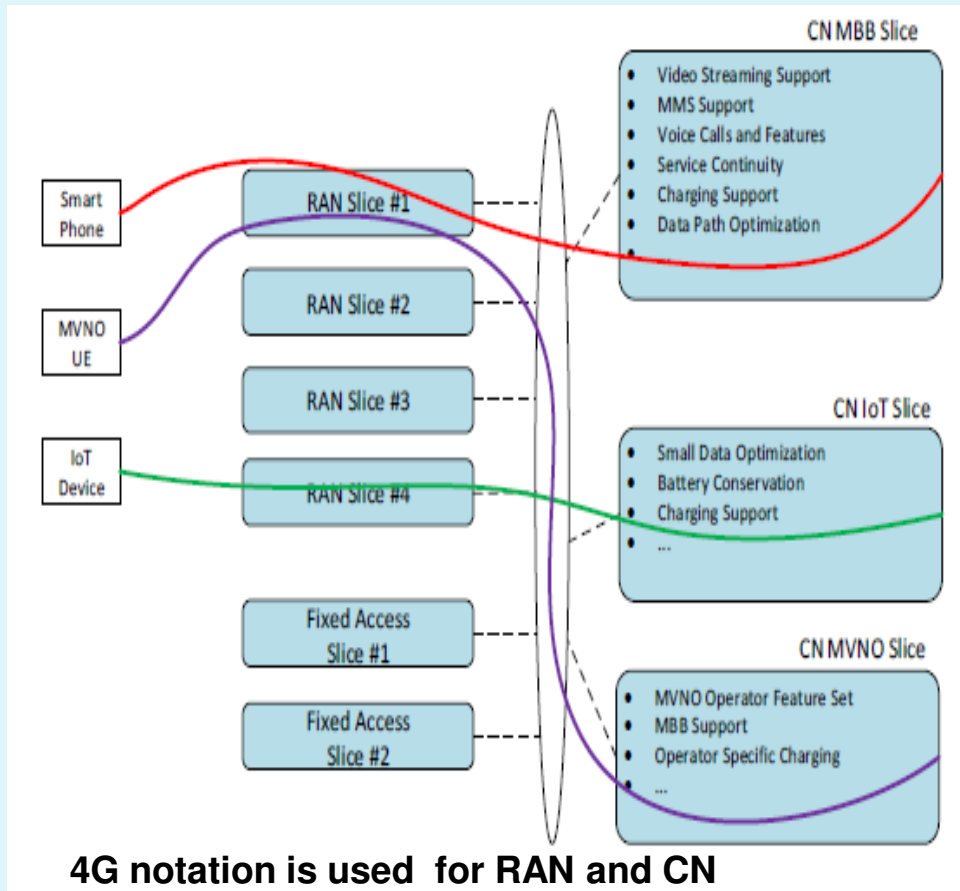

Source: 5G Americas, *Network Slicing for 5G Networks & Services*, 2016,  
[http://www.5gamericas.org/files/3214/7975/0104/5G\\_Americas\\_Network\\_Slicing\\_11.21\\_Final.pdf](http://www.5gamericas.org/files/3214/7975/0104/5G_Americas_Network_Slicing_11.21_Final.pdf)

InfoWare 2019 Conference, June 30 - July 04, Rome





# 1. Introduction



## 1.6 Business model (actors)- variant 1 of definition

- **Infrastructure Provider (InP)**– owns and manages a PHY network and its resources
  - The resources (WANs and/or data centers (DCs) **are virtualized** and then offered through programming I/Fs to a single or multiple tenants
- **Slice Tenant (ST)** – leases virtual resources from one or more InPs in the form of a virtual network, with which the tenant can realize, manage, and provide network services to its users
  - **Note: in this model the ST creates the slices and the associated services**
  - A network service is a composition (graph) of NFs; it is defined in terms of the individual NFs and the mechanism used to connect them
- **End user (EU):** consumes (part of) the services supplied by the tenant, without providing them to other business actors
- **Note: in other business models variants, the “tenant” is a generalized user of a slice, while the slices are constructed by a *slice provider or mobile network operator***

Source: J. Ordonez-Lucena, P. Ameigeiras, D. Lopez, J.J. Ramos-Munoz, J. Lorca, J. Folgueira, Network “Slicing for 5G with SDN/NFV: Concepts, Architectures and Challenges”, IEEE Communications Magazine, 2017

## 1.6 Business model (actors)- example - recursive model (cont'd)

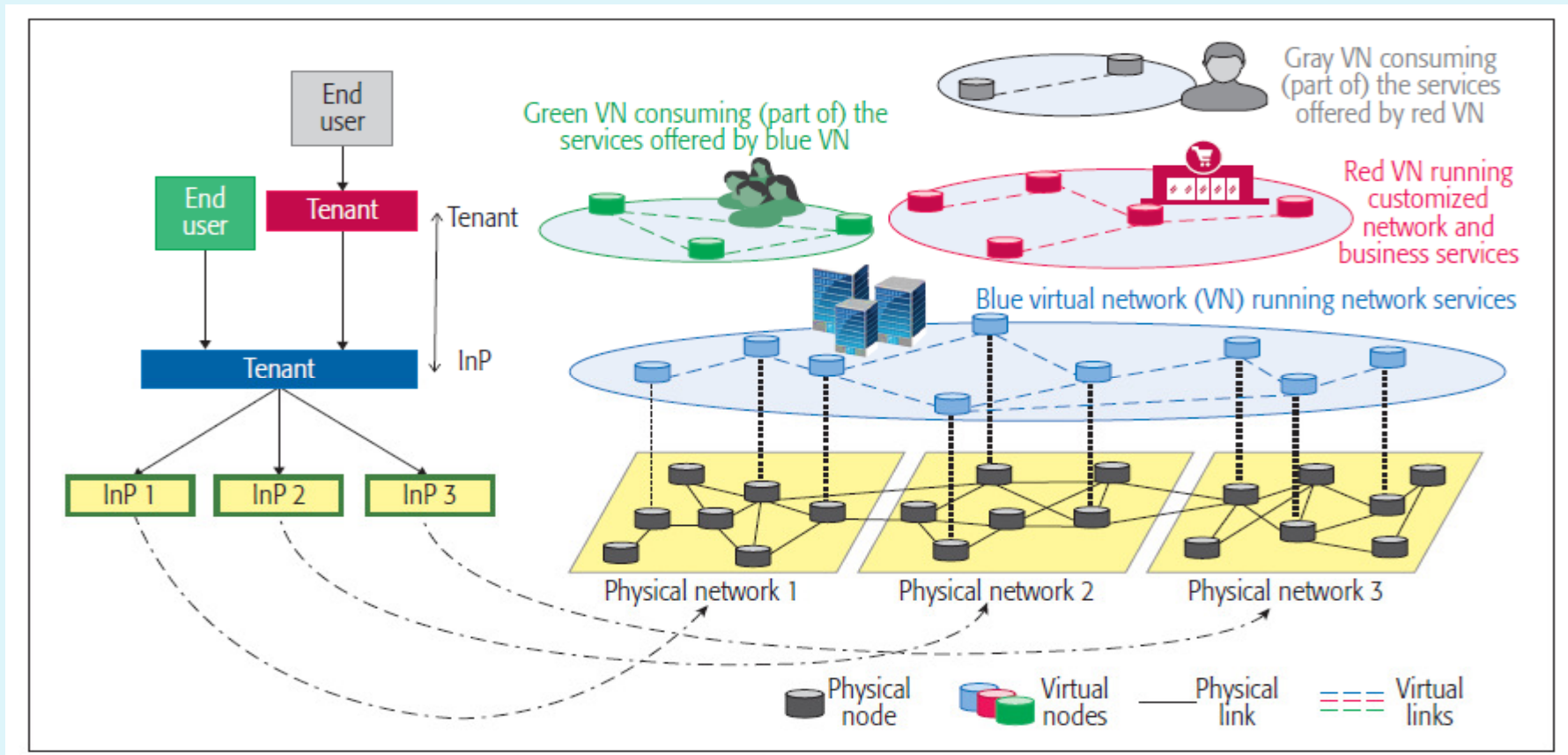

Source: J. Ordonez-Lucena, P. Ameigeiras, D. Lopez, J.J. Ramos-Munoz, J. Lorca, J. Folgueira, Network "Slicing for 5G with SDN/NFV: Concepts, Architectures and Challenges", IEEE Communications Magazine, 2017

InfoWare 2019 Conference, June 30 - July 04, Rome





# 1. Introduction



## 1.6 Business model (actors) - variant 2 of definition

- **Infrastructure Provider (InP)**– owner of the PHY infrastructure (network/cloud/data center)
  - it leases them to operators
  - It can become an SLP if it leases the infrastructure in slicing fashion
- **Slice Provider (SLP)** – typically a telecom SP, **owner or tenant** of the infrastructures from which network slices can be created
  - **Note: in this model the Slice Provider is distinctly defined**
- **Slice Tenant (ST)** - the user of specific network/cloud/data centre slice, in which customized services are hosted
  - Slice tenants can make requests to SLP, for creation of new infrastructure slice through a service model

*See A.Galis and K.Makhijani, Network Slicing Landscape: A holistic architectural approach, orchestration and management with applicability in mobile and fixed networks and clouds, v1.0, Network Slicing Tutorial – IEEE NetSoft 2018 – Montreal 29th June 2018.*

InfoWare 2019 Conference, June 30 - July 04, Rome



# 1. Introduction



## 1.7 Categories of 5G fundamental scenarios

- Massive machine type communication (mMTC)
- Ultra reliability low latency communication (URLLC)
- Enhanced mobile broadband (eMBB)
  - different requirements on 5G:
    - **functional** (e.g. priority, charging, policies, security, and mobility)
    - **performance** (e.g. latency, mobility, availability, reliability and data rates) → **dedicated slices can be constructed**

Characteristics	mMTC	URLLC	eMBB
Availability	Regular	Very High	Regular (baseline)
E2E latency	Not highly sensitive	Extremely sensitive	Not highly sensitive
Throughput type	Low	Low/med/high	Medium
Frequency of Xfers	Low	High	High
Density	High	Medium	High
Network coverage	Full	Localized	Full

Source: End to End Network Slicing – White paper 3 Outlook 21, Wireless World, Nov 2017

InfoWare 2019 Conference, June 30 - July 04, Rome



# 1. Introduction



## 1.8 Summary of Network Slices - key requirements

### ■ User/tenant related

- **NSL: dedicated logical networks, independent and self-contained**, built on **demand**, on a **common infrastructure**, supporting **at least one network service (NS)**, w/wo guarantees
- **abstraction capability**: creation of logically or physically isolated groups of network resources and VNF configurations
- **customizable NSes** (due to SDN and NFV support) and **powerful M&C** of the network resources
- **dynamic multi-service, multi-domain, multi-tenant** (independent of infrastructure) **E2E – capable**, integration of various market verticals
- **NSLs - configurable and programmable**; possible negotiation of parameters
- **fast** service/network **deployment, cost effective**

See: L. Geng , et.a.;, IETF- “Network Slicing Architecture draft-geng-netslices-architecture-02”, 2017  
A.Galis and K.Makhijani, Network Slicing Landscape: A holistic architectural approach, orchestration and management with applicability in mobile and fixed networks and clouds, v1.0, Network Slicing Tutorial – IEEE NetSoft 2018 – Montreal 29th June2018.

InfoWare 2019 Conference, June 30 - July 04, Rome



# 1. Introduction



## 1.8 Summary of Network Slices key requirements (cont'd)

- **NSL Management and control**
  - **embedded management concept**, including coordination/ orchestration of NFs and resources
  - **managed group of subsets** of resources, PNF/VNF at the D/U, C, M/O Planes
  - **automation** of
    - **network operation, LCM of network slicing** (create, deploy, change, delete) and **auto-healing**
  - **optimization of resources** (auto-scaling/migration)
  - efficient **cooperation between M&C planes and Data Planes**
  - NSL is seen by an operator as a complete network infrastructure which uses part of the infrastructure network resources
- **Scalability**- high: many slices (hundreds), large communities of customers (millions)
- **Reliability**- high: redundancy, isolation, fault detection and repair

*See: L. Geng , et.a.;, IETF- "Network Slicing Architecture draft-geng-netslices-architecture-02", 2017  
A.Galis and K.Makhijani, Network Slicing Landscape: A holistic architectural approach, orchestration and management with applicability in mobile and fixed networks and clouds, v1.0, Network Slicing Tutorial – IEEE NetSoft 2018 – Montreal 29th June2018.*

**InfoWare 2019 Conference, June 30 - July 04, Rome**



# 1. Introduction



## 1.8 Summary of Network Slices key requirements (cont'd)

- **Business and network operator/ SP**
- NSL should support
  - open possibility of **new business models**
  - industrial companies can use NSs as a part of their own services
  - **reduced operations expenditures** (OPEX)
  
  - **programmability** allows to enrich the offered services
  - **OTT providers** and other **market players can use NSLs without changing the PHY infrastructure**
    - to simplify the provisioning of services, manageability, integration and operation
    - to create a layer of abstraction by the creation of L/P isolated groups of network resources and VNFs
  - isolation, orchestration and separation of logical network behaviors from the underlying PHY network resources.

See: L. Geng, et al., IETF- "Network Slicing Architecture draft-geng-netslices-architecture-02", 2017  
A. Galis and K. Makhijani, Network Slicing Landscape: A holistic architectural approach, orchestration and management with applicability in mobile and fixed networks and clouds, v1.0, Network Slicing Tutorial – IEEE NetSoft 2018 – Montreal 29th June 2018.

**InfoWare 2019 Conference, June 30 - July 04, Rome**



# CONTENTS

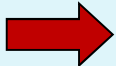

1. Introduction
2.  5G slicing relevant architectures
3. Management, orchestration and control
4. Cognitive technologies in 5G slicing M&C
5. Conclusions and research challenges

### 2.1 Slicing variants 3GPP, TR 23.799 V14.0.0 (2016-12)

- **Potential solution scenarios for support of multiple slices per UE**
  - Three groups of solutions defined by 3GPP-for **Core Network (CN)** slicing
  - **Group A** - the UE gets services from **different NSLs** and **different CN instances**
    - (+) **easiest logical separation/isolation** between the CN instances
    - independent subscription management/mobility management for each network slice handling the UE
    - (-) **potential side effects** of additional signalling in the network and over the air

CP – Control Plane  
UP – User (Data) Plane

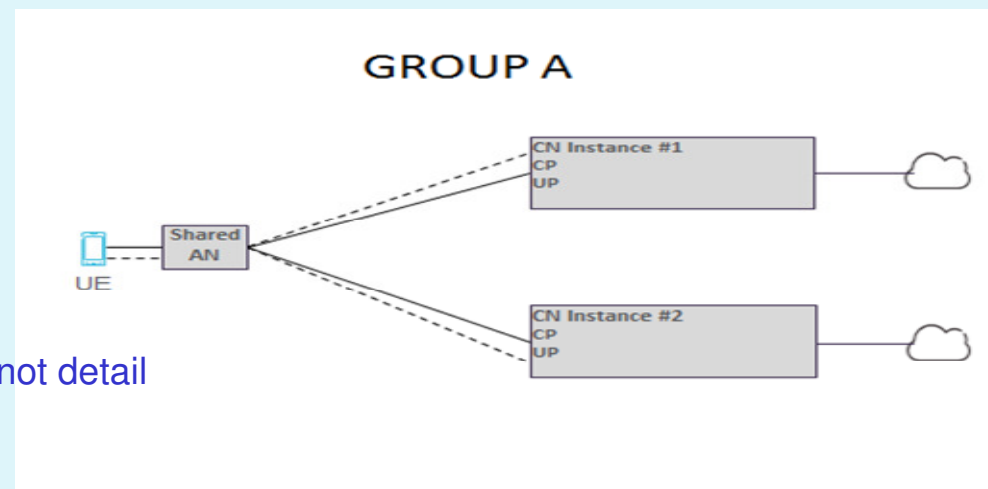

Note: This approach does not detail the slicing at AN premises

See: 3GPP, TR 23.799 V14.0.0 (2016-12), Study on Architecture for Next Generation System (Release 14)

InfoWare 2019 Conference, June 30 - July 04, Rome

## 2. 5G slicing relevant architectures

### 2.1 Slicing variants 3GPP, TR 23.799 V14.0.0 (2016-12)

- Solutions defined by 3GPP-for **Core Network (CN)** slicing (cont'd)
- **Group B** - some **NFs are common** between the NSLs, while **other functions reside in individual NSLs**
- **Group C** - the **Control Plane is common between the slices**, while the User plane(s) (UPI/DPI) are handled as different NSLs

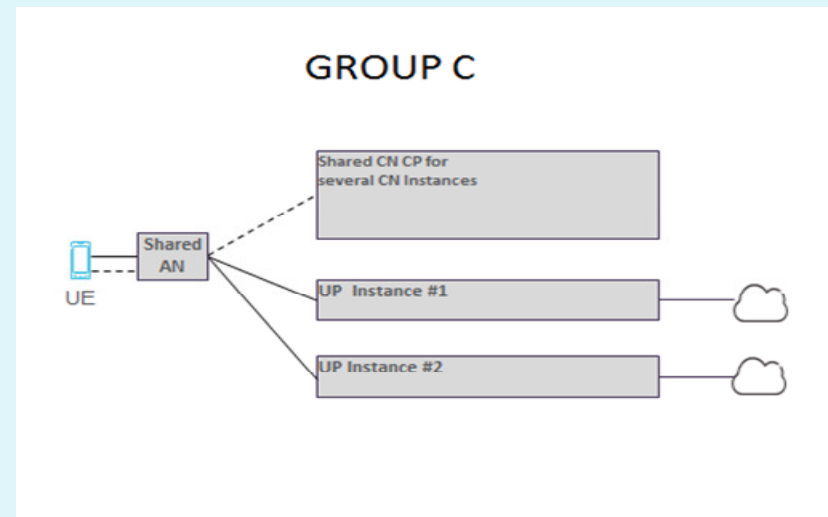
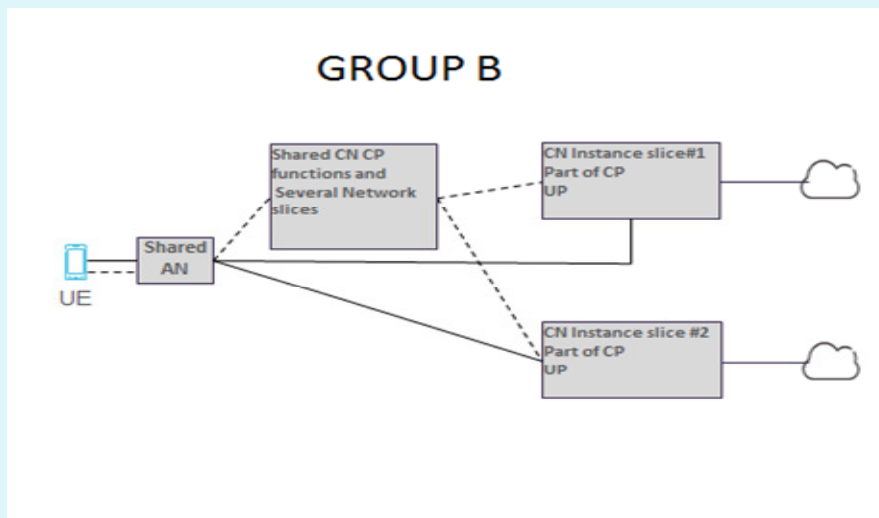

Note: This approach does not detail the slicing at AN premises

See: 3GPP, TR 23.799 V14.0.0 (2016-12), Study on Architecture for Next Generation System (Release 14)  
InfoWare 2019 Conference, June 30 - July 04, Rome



### 2.2 Slicing variants - examples

End to End services provided by NSLI(s)

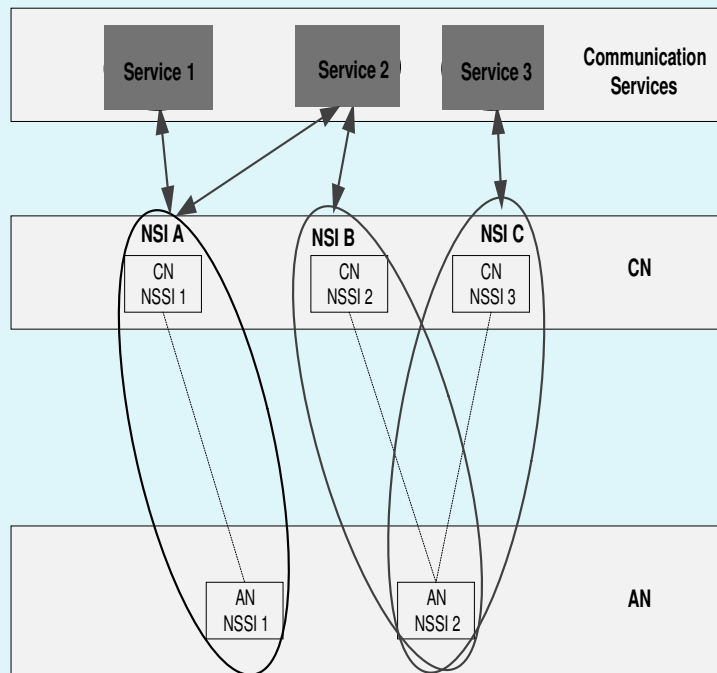

One NSSI can contribute to several NSLIs  
E.g., NSLI X and Y composed by NSSI A, B and C

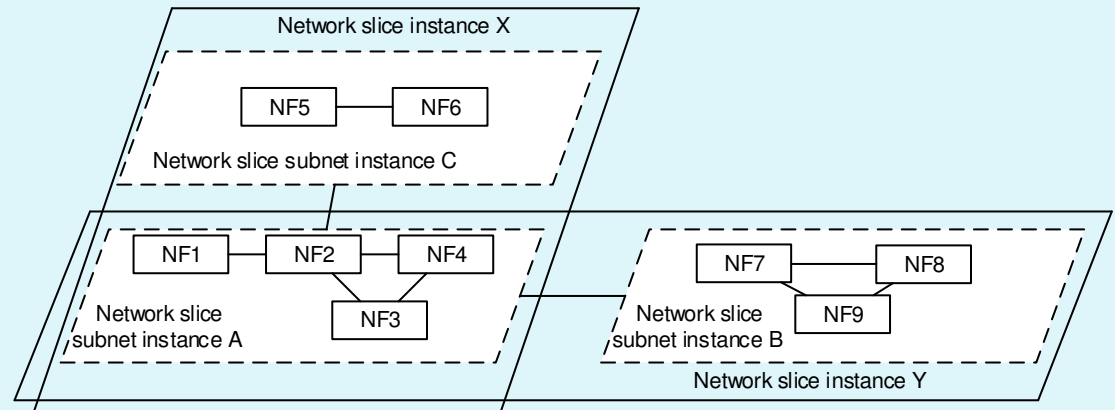

Source: 3GPP TR28.801 V15.1.0 (2018-01), Study on management and orchestration of network slicing for next generation network, (Release 15)

InfoWare 2019 Conference, June 30 - July 04, Rome

## 2. 5G slicing relevant architectures

### 2.3 ETSI and 3GPP functional architectures for slicing support

- Network slice management (NSLM) in NFV framework

New slicing mgmt. components added to NFV framework

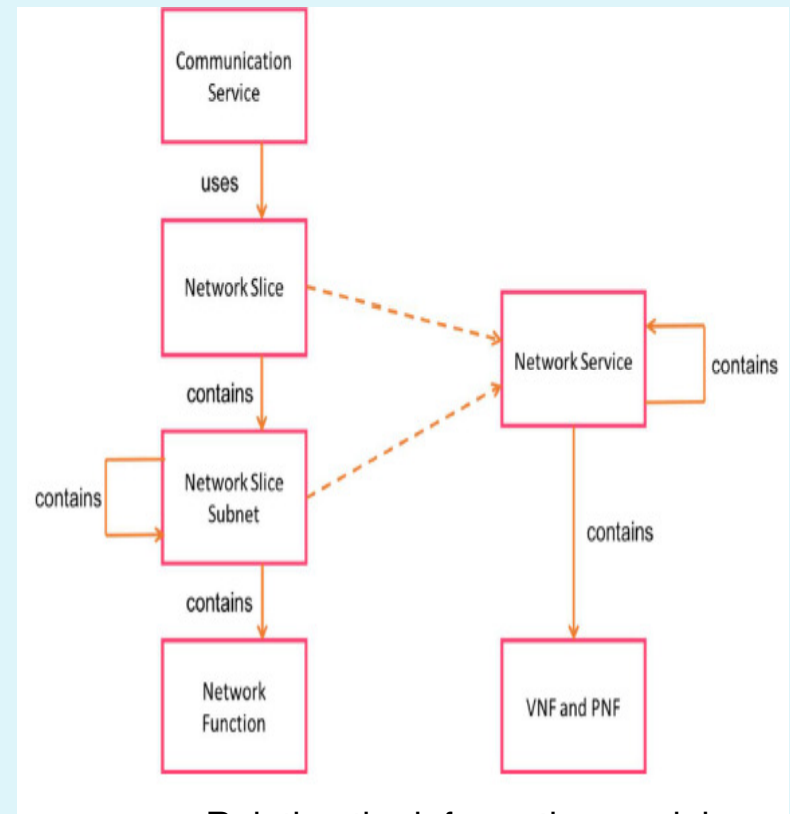
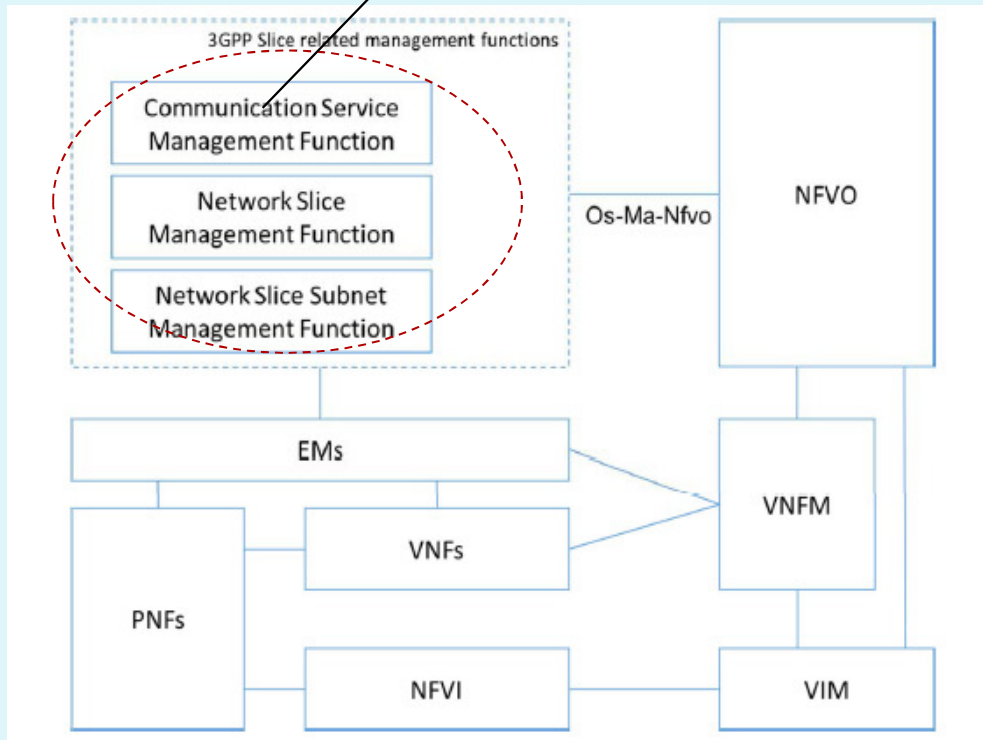

Relating the information models

Source: ETSI GR NFV-EVE 012 V3.1.1 (2017-12), Release 3; NFV Evolution and Ecosystem; Report on Network Slicing Support with ETSI NFV Architecture Framework



## 2. 5G slicing relevant architectures



### 2.3 ETSI and 3GPP functional architectures for slicing support

- **Network slice management (NSM) in NFV framework (cont'd)**
- **Three layered functions** related to NSL mgmt.
  - **Communication Service Management Function (CSMF):** translates the comm. service requirements to NSL requirements; I/F with **(NSMF)**
  - **Network Slice Management Function (NSLMF)** – management (including lifecycle) of NSLIs
    - It derives NSL subnet requirements from the NSL related requirements
    - I/F with NSSMF and the CSMF
  - **Network Slice Subnet Management Function (NSSMF)** – mgmt (including lifecycle) of NSSIs.
    - I/F with the NSMF
- The **Os-Ma-NFVO Reference Point (RP)** is the I/F with NFV-MANO
- The NSMF and/or NSSMF have to
  - determine the **type of NSL** or set of NSLs, **VNF and PNF** that can support the resource requirements for a NSLI or NSSI
  - analyze if existing instances can be re-used, else need to create new instances of these NSLs, VNFs and the connectivity to the PNFs

*See ETSI GR NFV-EVE 012 V3.1.1 (2017-12), Release 3; NFV Evolution and Ecosystem; Report on Network Slicing Support with ETSI NFV Architecture Framework*

**InfoWare 2019 Conference, June 30 - July 04, Rome**



## NFV summary 1/2 (complementary slide)



- **Network Function Virtualisation – ETSI- summary**
- **High level view of NFV framework ( recall)**
- **Working domains** composed of
  - **VNF** -SW implementation of a NF which is running over the NFVI
  - **NFV Infrastructure (NFVI)**, including the diversity of physical resources and virtualisation tools
    - NFVI supports the execution of the VNFs
    - The **Virtualisation Layer (VL)** abstracts the HW resources and decouples the VNF software from the underlying hardware, thus ensuring a HW-independent lifecycle for the VNFs
  - **NFV Management and Orchestration (NFV-MANO)**
    - **orchestration** and **lifecycle management (LCM)** of physical and/or SW resources that support the infrastructure virtualisation, and the VNFs lifecycle management
    - NFV MANO focuses on management of all virtualisation-specific tasks

*See: ETSI GS NFV 002 v1.2.1 2014-12, NFV Architectural Framework*

**InfoWare 2019 Conference, June 30 - July 04, Rome**



## NFV summary 2/2 (complementary slide)



- **Network Function Virtualisation – ETSI- summary (cont'd)**
- **NFV Management and Orchestration Architectural Framework (NFV-MANO Architectural Framework):**
  - collection of all FBs (those in NFV-MANO and others interworking with NFV-MANO), data repositories used by these FBs , and Reference Points (RPs) and interfaces for the purpose of managing and orchestrating NFV
- **Network Functions Virtualisation Orchestrator (NFVO):**
  - FB that manages the **Network Service (NSrv)** lifecycle and coordinates
    - the management actions for NSrv lifecycle
    - VNF lifecycle (supported by the VNFM)
    - NFVI resources (supported by the VIM)
  - to ensure an optimized allocation of the necessary resources and connectivity

*See: ETSI GS NFV 002 v1.2.1 2014-12, NFV Architectural Framework*

**InfoWare 2019 Conference, June 30 - July 04, Rome**

## 2.3 5G Layered Architecture - 5GPPP vision

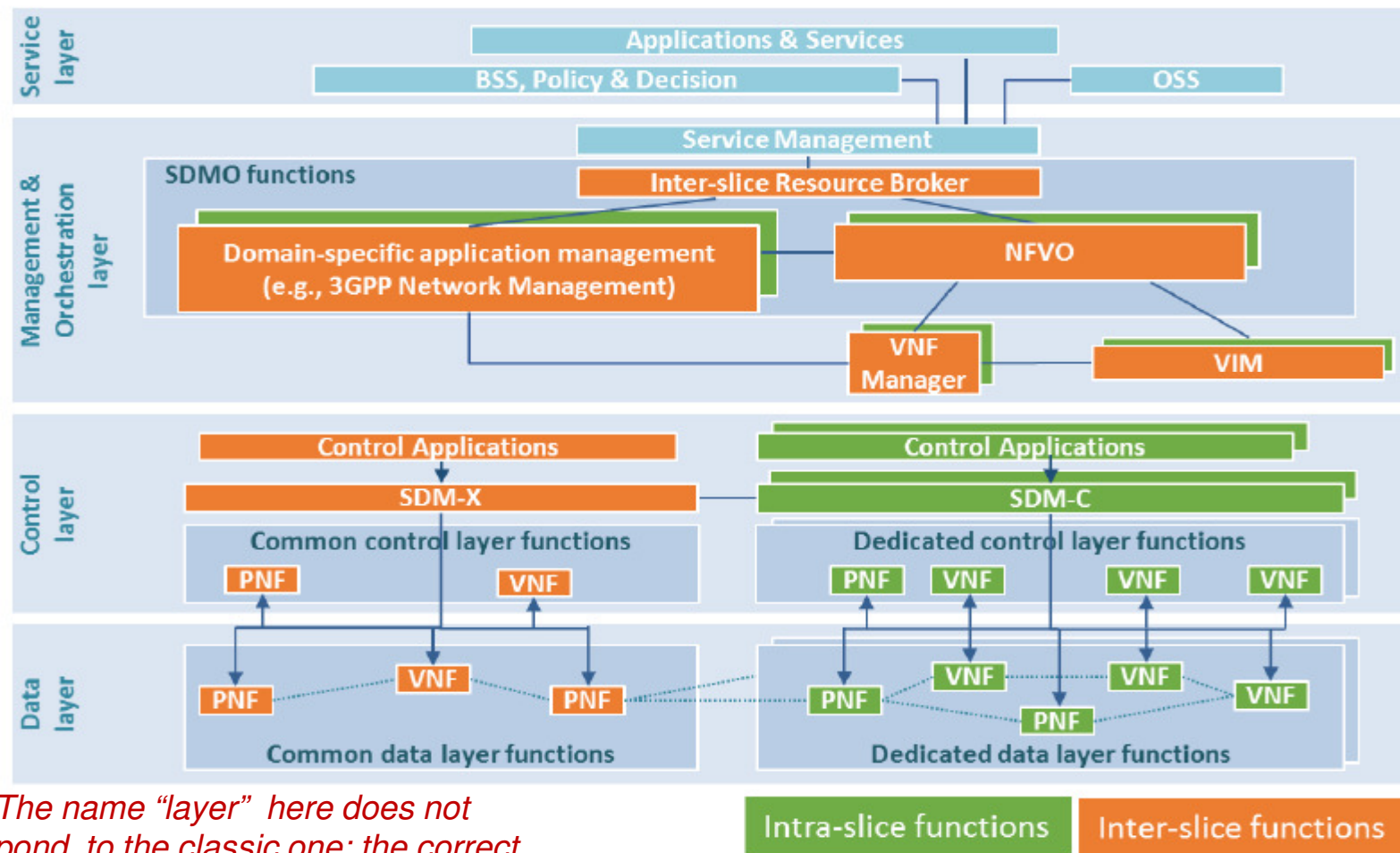

**Note:** The name “layer” here does not correspond to the classic one; the correct semantic would be rather - “plane”

Source: 5GPPP Architecture Working Group , View on 5G Architecture, Version 2.0, December 2017

InfoWare 2019 Conference, June 30 - July 04, Rome



## 2. 5G slicing relevant architectures-examples



### 2.3 5G Layered Architecture - 5GPPP vision (see the previous slide)

- **Architecture based on ETSI-NFV and SDN**
- **Service layer**
  - **Apps. and services** operated by the tenant (includes the E2E orch. system)
  - **Business Support Systems (BSSs); Business-level Policy and Decision** functions
  - **Operation Support System**
- **Management and Orchestration layer**
  - **Service Management** (i.e., services offered by the slices)
  - **Software-Defined Mobile Network Orchestrator (SDM-O)**
    - **Inter-slice resource Broker** (handles cross-slice resource allocation)
    - **ETSI NFV - MANO higher level functions (NFVO)**
    - **Domain specific application manager** (e.g., 3GPP Net Mng)
  - **ETSI NFV MANO lower level functions (VIM, VNF Manager)**
- **Control layer** : Software-Defined Mobile Network ...
  - ...**Coordinator (SDM-X) – inter-slice; ...Controller (SDM-C) – intra-slice**
  - other control applications
- **Data layer** - VNFs and PNFs needed to carry and process the user data traffic
- **Auxiliary: Multi-Domain Network Operating System Facilities**
  - different adaptors and network abstractions above the networks and clouds heterogeneous fabrics

*See: 5GPPP Architecture Working Group , View on 5G Architecture, Version 2.0, December 2017*



## 2.4 Multi-tenant – multi-domain architectures – ETSI ( run-time phase)

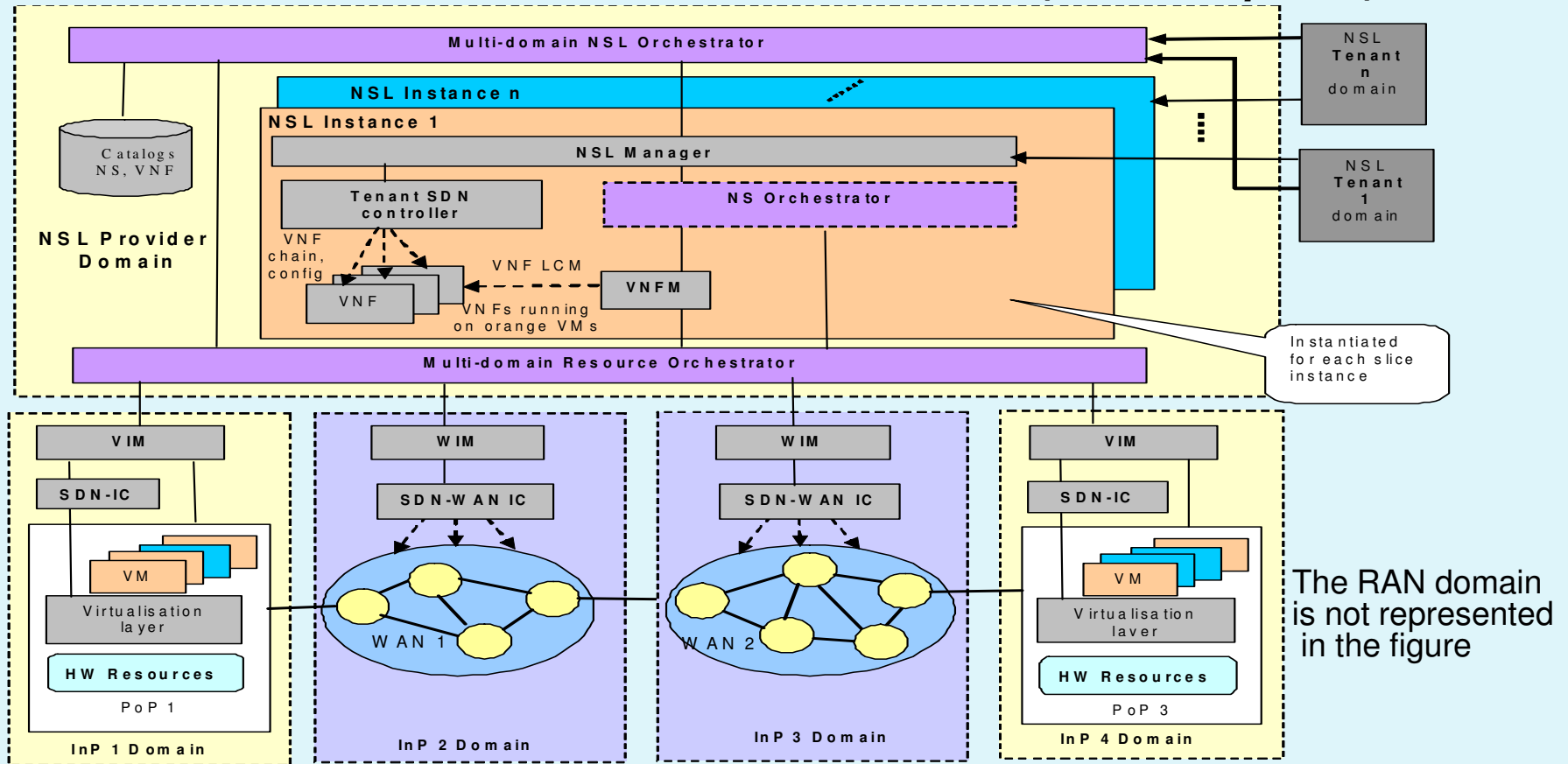

Adapted from source: J.Ordonez-Lucena, et al., "The Creation Phase in Network Slicing: From a Service Order to an Operative Network Slice", *European Conf. on Networks and Comm. (EuCNC), 2018*, <https://arxiv.org/abs/1804.09642>  
 ETSI GR NFV-EVE 012 V3.1.1 (2017-12), Release 3 "NFV Evolution and Ecosystem; Report on Network Slicing Support with ETSI NFV Architecture Framework".

InfoWare 2019 Conference, June 30 - July 04, Rome





## 2. 5G slicing relevant architectures



### 2.4 Multi-tenant – multi-domain architectures – ETSI (cont'd- for previous slide)

- **Two macro-“layers”...**
  - **NSL Provider Domain** - Upper part
  - **Infrastructure Domains** – Lower part
- ...supporting  $m \times$  **Tenants**
  
- **NSL Provider (of multi-tenant and/or multi-domain slices)**
  - **NLS Orchestrator (NSLO)** - highest management level
  - NS, VNFs catalogues
  - **Resource Orchestrator (RO)**
    - Both **NSLO** and **RO** are multi-domain capable
  
  - $n \times$  **NSL instances** (each having its own MPI, CPI and DPI)
    - NSLI Management = extended NFV framework + SDN control
    - One Tenant can run one or more NSLIs
  
- **Infrastructure Domains** (multi- infrastructure providers)
  - **Points of Presence (PoP)**- computation, storage, networking resources
    - managed by VIMs
  - **Networks** – connectivity resources
    - managed by Wide Area Infrastructure Managers (WIMs)



## 2. 5G slicing relevant architectures



### 2.4 Multi-tenant – multi-domain architectures – ETSI (cont'd)

- **The NSL provider**
  - can simultaneously operate multiple NSLs
  - rents the infrastructure resources owned by the InPs
- NSLs are **mutually isolated**: w.r.t **performance, resiliency, security, privacy and management**
  - they run concurrently on top of a shared NFVI without (directly or indirectly) affecting each other
  - the infrastructure (and NFVI) is owned and managed by different (and potentially non-trusted) administrative domains (InP1, InP2, ..)
  - Details on isolation: e.g., ETSI GS NFV-EVE 005, R NFV-IFA 022 and GR NFV-IFA 028
- **NSL Orchestrator (NSLO)**- highest layer of the architecture
  - **key** role in the **creation** phase and also in the **run-time** phase



## 3. Management, orchestration and control



### 2.4 Multi-tenant – multi-domain architectures – ETSI (cont'd)

- **NSLO role at creation phase**
  - It receives the order to deploy a NSLI for a tenant (or, the Slice Provider decides to construct a slice)
  - It has information (including on multi-domain) as to check the *feasibility* of the order
    - interacts with RO and accesses the VNF and NS Catalogues
    - the catalogues contain VNF and NS descriptors, exposing the capabilities of all the VNFs and NSs that an NSL provider can select for the NSLs
  - if feasible order, then NSLO triggers the instantiation of the NSL
- **NSLO role at run-time phase**
  - performs policy-based inter-slice operations
    - e.g., it analyzes the performance and fault management data received from the operative NSLs instances, to manage their SLAs
    - If SLA violations, the NSLO decides to modify/correct some NSLs
- **Resource Orchestration (RO)**
  - uses the resources (supplied by the VIMs/WIMs) and dispatches them to the NSL instances in **an optimal way**
    - To do this, it needs to know the resource availability in each domain (**this supposes a set of inter-domain interactions**)



## 2. 5G slicing relevant architectures



### 2.4 Multi-tenant – multi-domain architectures – ETSI (cont'd)

- **A NSL instance (NSLI)**
  - may be composed of one or more *Network Service (NS)* instances
    - instance of a simple NS
    - instance of a composite NS
    - concatenation of simple and/or composite NS instances
  - can span several *Infrastructure Providers (InP)* and/or admin. domains
  - has its own MPI and CPI planes and this provides isolation across NSIs
    - **NSL Manager**
    - **Network Service Orchestrator (NSO)**
    - **Tenant SDN Controller (TSC)**
    - **VNF Manager (VNFM)**
      - The VNFM(s) and the NSO perform the required life cycle operations (e.g., instantiation, scaling, termination, etc.) over the instances of the VNFs and NS(s), respectively
  
- **NSL Manager** – key element for a NSL tenant
  - coordinates the O&M data, from both NSO and TSC
  - performs the FCAPS – set of functions within the NSLI
  - provides visibility and mgmt. capability exposure to external blocks
  - establishes the limits within each tenant may operate and consume its NSLI instance



## 2. 5G slicing relevant architectures



### 2.4 Multi-tenant – multi-domain architectures – ETSI (cont'd)

- The **VNFM(s)** and the **NSO** perform
  - life cycle operations (e.g., instantiation, scaling, termination, etc.) over the instances of the **VNFs** and **NS(s)**, respectively
  - these operations involve modifying the amount of resources to be allocated for those instances → an interaction with RO is needed
- **Tenant SDN Controller (TSC)**
  - dynamically **configures and chains VNFs** to realize network services (NS) in the tenant domain (TSC can be deployed as a VNF itself)
    - it chains the VNF instances for NS construction, leveraging the forwarding DPI capabilities
  - It configures the VNF instances at *application level* but not their underlying NFVI resource (it creates an overlay of VNFs)
  - It plays the role of an *Element Manager (EM)* ( see ETSI NFV framework)
  - It offers a set of **dedicated northbound I/Fs** that allows slice's clients (and thus tenant's clients) to interact with the slice
  - **NSrvs and VNF operations are highly correlated** → after a NS has been instantiated, the OSS (an SDN app. from the TSC perspective), will instruct TSC to perform the VNF configuration and chaining tasks



## 2. 5G slicing relevant architectures



### 2.4 Multi-tenant – multi-domain architectures – ETSI (cont'd)

- **NFVI level**
  - NFV and SDN solutions are applied
  - M&C: **VIM, WIM, SDN Infrastructure controllers**
  - Each **NFVI-PoP** has a single **VIM instance** to configure and manage the virtualization containers and their underlying HW
    - Their connectivity is locally enforced by the **infrastructure SDN controller (IC)**
    - To connect NFVI-PoPs, each WAN domain relies on a **WAN Infrastructure Manager (WIM)** instance, (similar to the model in ETSI GR NFV-IFA 022)
  - The scenario presented above is well-aligned with the **NFVI as a Service (NFVlaaS)** (ETSI GR NFV-IFA 028)
  - Each tenant uses the NFVI to get the performance needs of the slices in its domain
    - each **InP** plays the **NFVlaaS provider** role
    - each **tenant** acts as an **NFVlaaS consumer**



## 2. 5G slicing relevant architectures



### 2.4 Multi-tenant – multi-domain architectures – ETSI (cont'd)

- A **tenant**, with its own set of NSLs is **isolated** from others
  - both **VIMs and WIMs support multi-tenancy**
  - by offering separate NFVI resources to subscribed tenants through dedicated I/Fs
- **VIMs has a resource pooling mechanisms** to provide subscribed tenants
  - with isolated resource environments endowed with high availability
  - fault resilience features to support the tenant VNFs deployment
- **WIMs have similar mechanisms** (e.g., those of the ONF TR 527)
  - to simultaneously manage a number of virtual topologies in the WAN with different levels of abstraction

*See: ETSI GR NFV-EVE 012 V3.1.1 (2017-12), Release 3; NFV Evolution and Ecosystem; Report on Network Slicing Support with ETSI NFV Architecture Framework*

InfoWare 2019 Conference, June 30 - July 04, Rome



## 2. 5G slicing relevant architectures



### 2.4 Multi-tenant – multi-domain architectures – ETSI (cont'd)

- The **infrastructure SDN controller (IC)**
  - M&C for the NFVI resources (placed in a NFVI-PoP or a WAN)
  - set up the connectivity to support the communication between the tenant VNFs and/or PNFs in the infrastructure domain
  - performs M&C of the connectivity among the **virtualization containers** that host the tenant VNFs' software applications
  - the networking resources, supporting VM (and hence VNF) connectivity at the infrastructure level, are managed by the ICs following the managers VIM and the WIM commands
  - **VIMs and WIMs act as SDN applications**, delegating to ICs the M&C tasks related to networking resources
  - Implementation variant: to integrate ICs into their corresponding VIMs

*See: ETSI GR NFV-EVE 012 V3.1.1 (2017-12), Release 3; NFV Evolution and Ecosystem; Report on Network Slicing Support with ETSI NFV Architecture Framework*

InfoWare 2019 Conference, June 30 - July 04, Rome





# CONTENTS



1. 5G Network slicing – concepts, use cases and requirements
2. 5G slicing relevant architectures
3. **➔ Management, orchestration and control**
4. Cognitive technologies in 5G slicing M&C
5. Conclusions and research challenges



## 3. Management, orchestration and control



### 3.1 General requirements for 5G slicing management, orchestration and control

- To support flexible business models (various actors)
- Ability to create/support-- on demand/provisioned slices
  - in multi-tenant, multi-domain, multi-operator, E2E environments
  - to offer Network Slice as a Service
  - to offer guaranteed and non-guaranteed services
    - Quality of Service control and assurance
- Scalability (horizontal and vertical)
- Flexibility (resource allocation optimization, slice scaling, ..)
  - Dynamic and autonomic/cognitive management
- Sustainability (including energy management)
- Security (including slice isolation)
- Open system (new components can be added)
- Capable to embed/cooperate with 3G, 4G, WiFi, etc.- technologies
- Based on auxiliary technologies: Cloud/edge, NFV, SDN, NFV



## 3. Management, orchestration and control



### 3.2 Specific aspects

- **E2E Orchestration**
  - Three levels of orchestration: **services**, **slices** and **resources**
  - Coordination of related resources in a number of subordinate domains
  
  - **Autonomic coordination of**
    - slice **life cycle management (LCM)**
    - concatenation/stiching of slices in each segment of the infrastructure (in M/C/DPI planes)
      - stiching = existing slice functional modification by adding/merging functions of another slice
    - slice elasticity and placement, dynamic resources (re)-configuration

*See also:*

*A.Galis, 5G Architecture Viewpoints H2020 5G PPP Infrastructure Association July 2016, August 2017, <https://5g-ppp.eu/white-papers/>*

*A.Galis, "Network Slicing - Management Challenges", IRTF 102 – NMRG, 2018*

**InfoWare 2019 Conference, June 30 - July 04, Rome**



## 3. Management, orchestration and control



### 3.2 Specific aspects

- **Network Slice Life Cycle Management**
  - grouping of P/V network resources
  - exposing the network infrastructure capabilities to tenants
  - cooperation with template/NS repository
  - creation, activation /deactivation, protection, elasticity, extensibility, safety, and sizing of slices
    - instantiation of the network and service functions assigned to the slice
  - individual slice management
  
- **Network Slicing Optimisation**
  - methods for automatic selection of network resources for NS
  - global resource views
  - global energy views
  - Network Slice deployment based on global resource and energy efficiency
  
- **Guaranteed QoS / KPIs characteristics**



## 3. Management, orchestration and control



### 3.2 Specific aspects

- **Monitoring and Discovery**
  - embedding the mgmt. traditional functions FCAPS (Fault, Configuration, Accounting, Performance, Security)
  - continuous monitoring of each NSLI state
  - collect information on resource allocation and network functions instances in a NSL
  - discovery and monitoring probes are needed in all NSL components
  
- **Autonomic/cognitive slice management:**
  - aiming to solve the allocation of resources between slices and real-time optimization of slice in adaptive way
  
- **Service and data model & mapping – is necessary**
  - the network – to be physically distributed -> service mapping enables on-demand processing anywhere, with dynamic and fine granular service (re)-provisioning
  - slice-aware information model of connectivity, storage, compute resources, NFs, capabilities exposed and service elements.

### 3.3 Network slice instance life-cycle

- Functions provided by the NSLM system in several phases for a NSLI life cycle
  - Preparation phase
  - Instantiation, Configuration and Activation phase
  - Run-time phase
  - Decommissioning phase

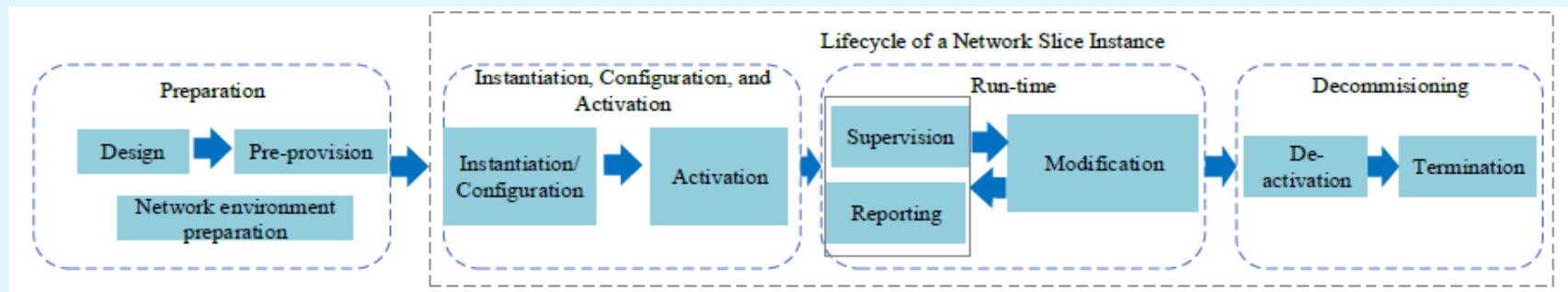

- Details:
  - **Preparation phase** (the NSLI does not exist yet)
    - creation and verification the feasibility of NSL template(s)
    - preparation of the necessary network environment to support the NSLIs lifecycle (e.g., provisioning databases)

*See: End to End Network Slicing – White paper 3 Outlook 21, Wireless World, Nov 2017*



## 3. Management, orchestration and control



### 3.3 Network slice instance life- cycle (cont'd)

Functions provided by the NSLM system in several phases for a NSLI life cycle

#### ■ **Instantiation / configuration**

- It can include **instantiation, configuration and activation** of various shared and/or non-shared NFs
- All resources shared/dedicated to the NSLI are created and configured, i.e. to a state where the NSLI is ready for operation
- **Activation** : makes the NSLI active, e.g. diverting traffic to it

#### ■ **Run-time phase**

- NSLI **handles traffic** to support services of certain type(s)
- **Supervision/reporting** (e.g. for KPI monitoring)
- **Modification** could be: upgrade, reconfiguration, NSI scaling, Possible **changes** of NSLI capacity, changes of NSLI topology, association and disassociation of NFs with NSLI

#### ■ **Decommissioning phase**

- **Deactivation** (taking the NSLI out of active duty)
- Release the dedicated resources (e.g. **termination** or re-use of NFs ) and configuration of shared/dependent resources
- Finally, the NSLI does not exist anymore

## 3.4 Generic service management and network slice control- example

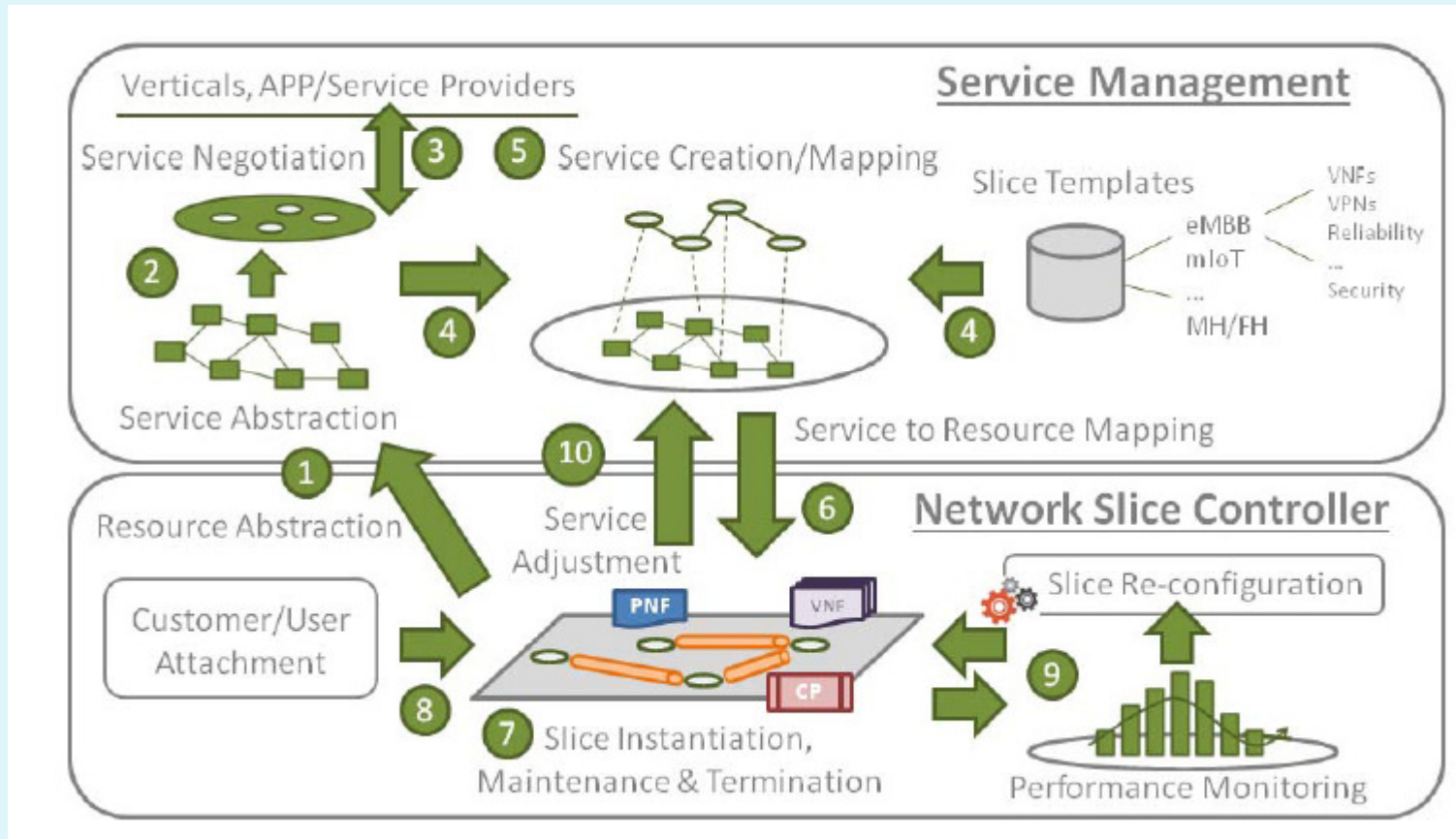

Source: Ibrahim Afolabi, Tarik Taleb, Konstantinos Samdanis, Adlen Ksentini, and Hannu Flinck, *Network Slicing and Softwarization: A Survey on Principles, Enabling Technologies, and Solutions* IEEE COMMUNICATIONS SURVEYS & TUTORIALS, VOL. 20, NO. 3, THIRD QUARTER 2018 2429





## 3. Management, orchestration and control



### 3.4 Generic service management and network slice control- example (cont'd)

- *Roles of the planes*
- *Service management plane*- performs service operations
  - **abstraction, negotiation, admission control and charging** for verticals and 3rd parties
  - **service creation** if admission control accepts the slice request
    - AC input parameters: {slice reqs., slice templates available}
  - The desired service combines
    - VNFs, PNFs, value added services
    - data/control plane, and security mechanisms
    - and exposes them to the underlying network
- *Network slice management and control plane*
  - provides resource abstraction to service management
  - handles **NSL resource management & control plane** operations, including
    - instantiation of the slice resources based on the service mapping
    - performance maintenance via monitoring, analysis and slice re-configuration procedures
    - slice selection, attachment and support for multi-slice connectivity



## 3. Management, orchestration and control



### 3.4 Generic service management and network slice control (cont'd)

- **Actions** (related to previous slide)
  - (1) Network Slice M&C provides resource abstraction to service management
  - (2-3) abstraction, negotiation, AC and charging for verticals and 3rd parties
  - (4-5) service creation after a slice request is accepted by AC
  - (6) Srv. Mgmt provides all information to network slice M&C plane
  - (7) Net M&C **instantiates the slice resources** based on service mapping
  - (8) Net M&C performs slice selection, attachment and support for multi-slice connectivity
  - (9) Net M&C - performance maintenance via monitoring, analysis and slice re-configuration procedures



# CONTENTS



1. Introduction
2. 5G slicing relevant architectures
3. Management, orchestration and control
4.  Cognitive technologies in 5G slicing M&C
5. Conclusions and research challenges



## 4. Cognitive technologies in 5G slicing M&C



### 4.1 Cognitive Management concepts

- 5G slicing – has complex management requirements related to multi – tenant/domain/operator context and softwarization of network resources
- Need of real-time mgmt. based on a hierarchy of complex decision making techniques that analyze *historical, temporal and frequency network data*
- **Cognitive network management** – recent trend using **Artificial Intelligence (AI)** and in particular **Machine Learning (ML)** to develop **self-x**, (-x= -aware, -configuring, -optimization, -healing and -protecting systems)
- Cognitive management– extension of **Autonomic Management (AM)** (coined by IBM ~ 2001)
  - **AM + Machine learning = Cognitive Management (CogM)**
- **Challenge:** to deploy the CogM and its orchestration across multiple heterogeneous networks: Radio & Other Access Networks, Core & Aggregation, Edge Networks, Edge and Computing Clouds and Satellite Networks

## 4. Advanced cognitive management

- **4.1 Cognitive Management concepts** (cont'd)
- **Autonomous Network Management (ANM)** : introduce **self-governed** networks for pursuing business and network goals while maintaining performance
- IBM original AM ( ~2001), later extended in networking domain → ANM
- **Loop:** The **Monitor-Analyze-Plan-Execute** over a shared Knowledge
- **(MAPE-K)** is a control theory-based feedback model for self-adaptive systems
- Full-duplex communication between *managing systems* *managed system* and the *environment*
- **AM** – hierarchical and recursive approach

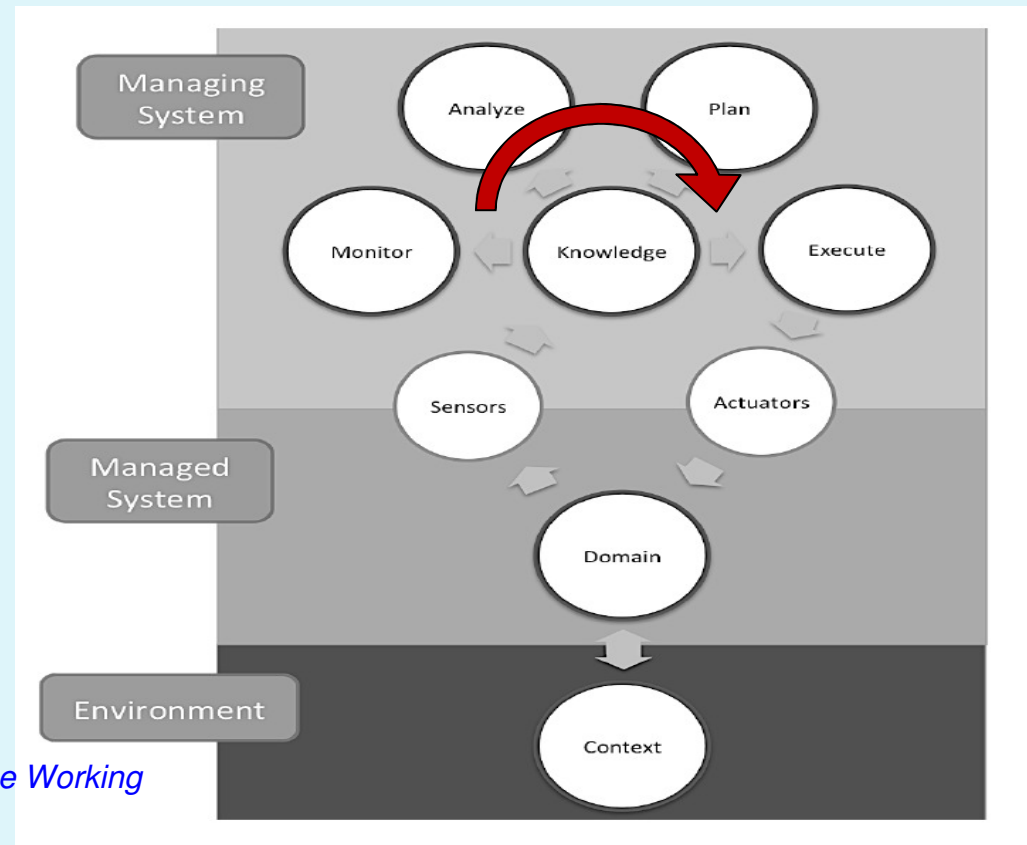

Source: 5GPPP Network Management & Quality of Service Working Group, "Cognitive Network Management for 5G", 2017



## 4. Cognitive technologies in 5G slicing M&C



### 4.1 Cognitive Management concepts (cont'd)

#### ■ Autonomic Network Management functions

- **Monitoring:** active/passive, centralized/distributed, granularity-based, timing-based and programmable
- **Analysis:** many approaches exist –relying, e.g., on probability and Bayesian models for anticipation on knowledge, timing, mechanisms, network, user, applications
  - **Challenge: to define a concentrated data set** that comprehensively captures information across all anticipation points
  - **Recent solutions – use learning and reasoning** to achieve such specific ends
- **Planning and Execution**
  - The network adaptation plan – several aspects: knowledge, strategy, purposefulness, degree of adaptation autonomy, stimuli, adaptation rate, temporal/spatial scope, open/closed adaptation and security
  - **Current status:** the adaptation solutions differ broadly and **there is no unanimity in defining proper planning and execution guideline**



## 4. Cognitive technologies in 5G slicing M&C



### 4.1 Cognitive Management concepts (cont'd)

- **Autonomic Network Management functions** (cont'd)
  - **Knowledge base**
    - The network information is shared across the MAPE-K architecture
    - Many approaches exist - to build knowledge on network/topology, including models from learning and reasoning, ontology and DEN-ng models
  - **Integrated solution-** able to capture knowledge on: ***structure, control*** and ***behaviour***
  - **Typically:**
    - to drive the decisions of **Self Organizing Network (SON)-type** (e.g., self-planning, self-optimization and self-healing )
      - the knowledge-based framework should
        - process the input data from multiple sources
        - extract relevant knowledge, **through learning-based classification, prediction and clustering models**



## 4. Cognitive technologies in 5G slicing M&C



### 4.2 Automation of 5G network slicing management which can benefit from AI/Machine Learning

- **Network functions requiring automation**
  - **Planning and design:** requirements and environment analysis, topology determination; it provide inputs to ↓
  - **Construction and deployment:** static resource allocation, VNF placement, orchestration actions; it provide inputs to ↓
  - **Operation, control and management:** dynamic resource (re)allocation, adjustment; policy adaptation; it interact bi-directionally with
    - **Fault detection:** Syslog analysis, behavior analysis, fault localization
    - **Monitoring:** Workload, performance, resource utilization
    - **Security:** Traffic analysis, DPI, threat identification, infection isolation

*Adapted from source: V. P. Kafle, et. al., "Consideration on Automation of 5G Network slicing with Machine Learning", ITU Kaleidoscope Santafe 2018*





## 4. Cognitive technologies in 5G slicing M&C



### 4.3 Machine Learning (ML) –summary

- (ML) (subset of AI)
- Traditional programming
  - Input Data, Rules (function) → **Computing Machine** → Output data
- **ML: The rules are not known in advance, but discovered by a machine**
- **ML idea: “Optimizing a performance criterion using example data and past experience”**
  - “A computer program is said to **learn** from **experience E** with, respect to some **class of tasks T** and **performance measure P**, if its performance at tasks in T, as measured by P, **improves with experience E.** “
    - *Tom Mitchell. Machine Learning 1997*
  - The **experience E** comes usually in the form of data
    - A **learning algorithm** is used to discover and learn knowledge or properties from the data
  - In some cases, algorithms learn by rewards and/or punishments
  - The **dataset quality or quantity** affect the learning and prediction perf.
  - After first learning, the ML can provide results, for new input unknown data

*See also other sources, like: Wei-Lun Chao, Machine Learning Tutorial, 2011,  
<http://disp.ee.ntu.edu.tw/~pujols/Machine%20Learning%20Tutorial.pdf>*

InfoWare 2019 Conference, June 30 - July 04, Rome



## 4. Cognitive technologies in 5G slicing M&C



### 4.3 Machine Learning (ML) –summary (cont'd)

- **Tasks (basic ML methods)**
- **Supervised learning (SML)** - predicting one or more dependent variables
  - based on (initially) labeled data
  - *use cases examples*: classification and regression
  - semi-supervised learning: not all data is labeled
  - active learning: the algorithm has to ask for some labels with a limited budget
- **Unsupervised learning (UML)**-look for structure in (unlabelled) data
  - *use cases examples*: clustering or pattern mining
- **Reinforcement learning (RL)** -using **feedback** to an **agent actions** in a dynamic environment
  - *use cases examples*: self driving cars, learning games, ...
  - no feedback on individual actions, just win or lose
- **Adversarial learning** -the environment tries to deceive the learner
  - could be supervised and unsupervised
  - use cases examples.: spam filters, malware detection

### 4.3 Machine Learning (ML) – summary (cont'd)

- **Phase (1) learning:** through the discovery of patterns, thanks to the data
  - The list of attributes used to solve **a problem** is called a **features vector** (this is a subset of the overall data that are used to tackle a problem)
  - Phase (1) is used to describe the data and summarize it into a model
- **Phase (2) Inference: using the model, test it on never-seen-before data**
  - The new data are transformed into a features vector, go through the model and give a prediction

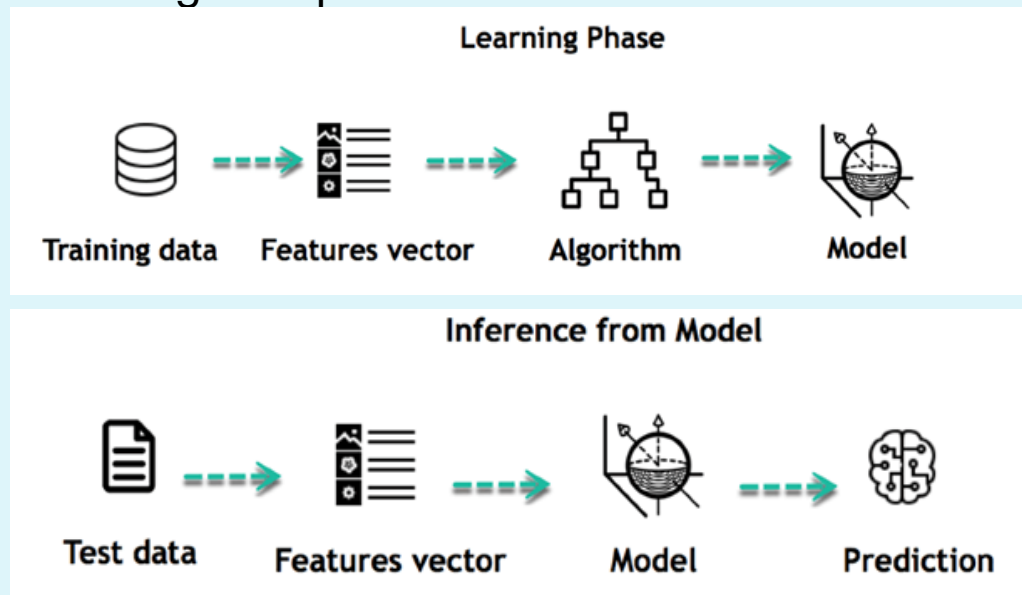

### General steps in ML life cycle

1. Define a question
2. Collect data
3. Visualize data
4. **Train algorithm**
5. **Test the algorithm**
6. **Collect feedback**
7. **Refine the algorithm**
8. Loop 4-7 until the results are satisfying
9. Use the model to make a prediction

Source: "Machine Learning Tutorial for Beginners", <https://www.guru99.com/machine-learning-tutorial.html>



## 4. Cognitive technologies in 5G slicing M&C

### 4.3 Machine Learning (ML) –summary (cont'd)

- In order to construct a ML system – a **human designer expert should**
  - define the questions/tasks, terminology, evaluation metrics
  - define the annotation of the training and testing data
  - have a good intuition on useful feature definition
    - **take care: defining the features could be more important than the choice of learning algorithm**
  - define the procedure for error analysis
  - define the constraints to guide the learning process
  
- **Evaluation guidelines in ML**
  - 1. **Phase 1 (training)** : selection of an evaluation procedure (a “metric”), e.g.:
    - for classification : accuracy- proportion of correct classifications?
    - for regression: mean squared error can be used
  - 2. **Phase 2 (testing on new data)**: applying the model to a test set and evaluate
    - The test set must be different from the training set

*See also: R.Johansson, Applied Machine Learning Lecture 1: Introduction, Univ. of Gothenburg, 2019, <http://www.cse.chalmers.se/~richajo/dit866/lectures/l1/l1.pdf>*

### 4.3 Machine Learning (ML) –summary (cont'd)

#### ■ Data set

- in ML an **universal dataset** is assumed to exist, containing all the possible data pairs + probability distribution of appearance in the real world
- in real apps., only a **subset** of the universal dataset is observed (because of reasons such as: memory limits, etc.)
  - this **acquired** dataset = **training set** and used to learn the properties and knowledge of the universal dataset
    - generally, vectors in the training set are assumed **independently and identically distributed** sampled (i.i.d) from the universal dataset
  - to examine the learning performance, another dataset may be reserved for testing, called the **test set**

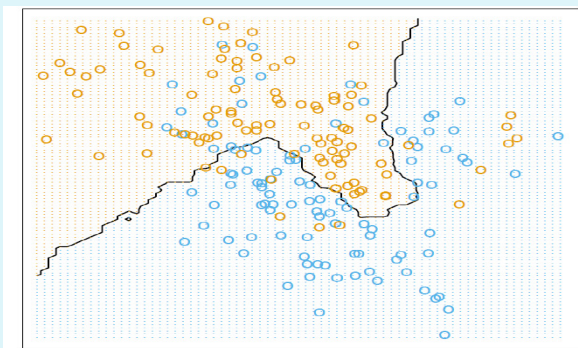

#### Two-class dataset example

- two measurements of each sample are extracted
- each sample is a 2-D vector

Source: Wei-Lun Chao, *Machine Learning Tutorial*, 2011,  
<http://disp.ee.ntu.edu.tw/~pujols/Machine%20Learning%20Tutorial.pdf>

InfoWare 2019 Conference, June 30 - July 04, Rome



## 4. Cognitive technologies in 5G slicing M&C



### 4.3 Machine Learning (ML) –summary (cont'd)

- Data set (cont'd)
  - General dataset types

**Labeled dataset**  $\mathcal{D}$  :  $X = \{\mathbf{x}^{(n)} \in R^d\}_{n=1}^N$ ,  $Y = \{y^{(n)} \in R\}_{n=1}^N$

- or

$\{\mathbf{x}^{(n)} \in R^d, y^{(n)} \in R\}_{n=1}^N$ , where each  $\{\mathbf{x}^{(n)}, y^{(n)}\}$  is called a data pair.

**Unlabeled dataset**  $\mathcal{D}$  :  $X = \{\mathbf{x}^{(n)} \in R^d\}_{n=1}^N$

- X denotes the **feature set** containing N samples. Each sample is a **d-dimensional vector**  $d$ -dimensional vector  $\mathbf{x}^{(n)} = [x_1^{(n)}, x_2^{(n)}, \dots, x_d^{(n)}]^T$
- Each dimension of a vector is called an **attribute, feature, variable, or element**
- Y = the **label set**, recording what label a feature vector corresponds (e.g., color of the points in the previous picture)
  - In some applications, the label set is *unobserved* or *ignored*

Source: Wei-Lun Chao, Machine Learning Tutorial, 2011,  
<http://disp.ee.ntu.edu.tw/~pujols/Machine%20Learning%20Tutorial.pdf>

InfoWare 2019 Conference, June 30 - July 04, Rome

### 4.3 Machine Learning (ML) –summary (cont'd)

#### ■ Data set types illustration

- The universal set is assumed to exist, but unknown (as a whole)
- A **subset** of universal set *is observed* through the *data acquisition process*
  - used for training (this is called - training set)
  - Two *learned separating lines* are shown in the training set and test set
  - these two lines give
    - 100% accuracy on the training set
    - they may perform differently in the test set (the curved line shows higher error rate)

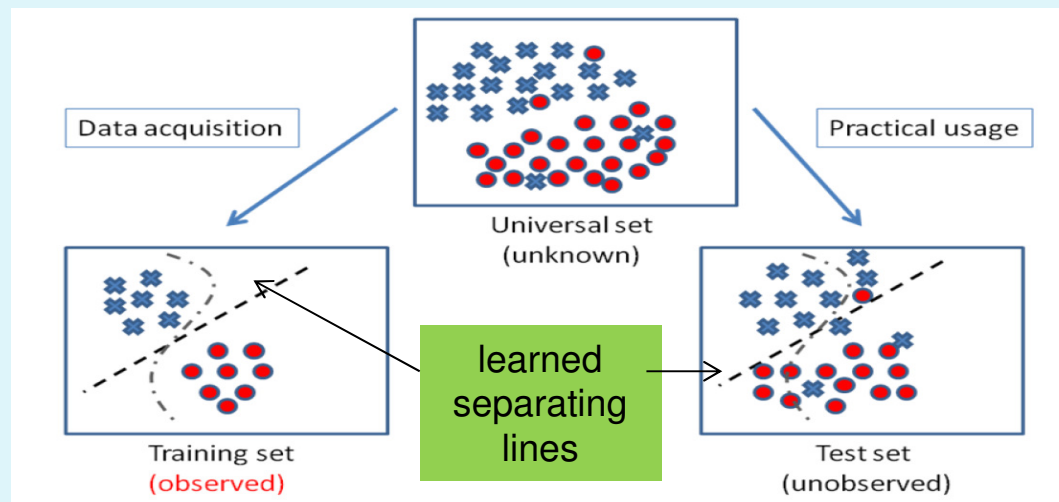

Source: Wei-Lun Chao, *Machine Learning Tutorial*, 2011,  
<http://disp.ee.ntu.edu.tw/~pujols/Machine%20Learning%20Tutorial.pdf>

InfoWare 2019 Conference, June 30 - July 04, Rome





## 4. Cognitive technologies in 5G slicing M&C



### 4.3 Machine Learning (ML) –summary (cont'd)

- Machine learning methods
- Supervised learning (SML)
- Given a set of  $N$  training examples of the form  $\{(x_1, y_1), \dots, (x_n, y_n)\}$  such that
  - $x_i$  is the feature vector of the  $i$ -th example and  $y_i$  is its label (i.e., class),
  - a learning algorithm seeks a function  $g: X \rightarrow Y$  where  $X$  is the input space and  $Y$  is the output space
- The function  $g$  is an element of a space of possible functions  $G$ , usually called the hypothesis space
- It is convenient to represent  $g$  using a scoring function  $f: X \times Y \rightarrow \mathbb{R}$ 
  - such that  $g$  is defined as that function which (returning the  $y$  value) gives the highest score:  $g(x) = \arg \max_y f(x, y)$

Example:  $y_i$  is the output associated with the vector  $x_i$

Given: Training data:  $(x_1, y_1), \dots, (x_n, y_n) / x_i \in \mathbb{R}^d$  and  $y_i$  is the label.

example $x_1 \rightarrow$	$x_{11}$	$x_{12}$	...	$x_{1d}$	$y_1 \leftarrow$ label
...	...	...	...	...	...
example $x_i \rightarrow$	$x_{i1}$	$x_{i2}$	...	$x_{id}$	$y_i \leftarrow$ label
...	...	...	...	...	...
example $x_n \rightarrow$	$x_{n1}$	$x_{n2}$	...	$x_{nd}$	$y_n \leftarrow$ label

Source: Machine Learning Basic Concepts [https://courses.edx.org/asset-1:ColumbiaX+CSMM.101x+1T2017+type@asset+block@AI\\_edx\\_ml\\_5.1intro.pdf](https://courses.edx.org/asset-1:ColumbiaX+CSMM.101x+1T2017+type@asset+block@AI_edx_ml_5.1intro.pdf)



### 4.3 Machine Learning (ML) –summary (cont'd)

- **Supervised learning (SML)** (cont'd)
- **SML algorithms-main applications: classification and regression**
  - **Classification** problem: if each feature vector  $x$  is corresponding to a label  $y \in L, L = \{l_1, l_2, \dots, l_c\}$  ( $c$  ranges from 2 to a hundred)
  - **Regression** problem: if each feature vector  $x$  is corresponding to a real value  $y$  (belongs  $\mathbb{R}$ )

Classification

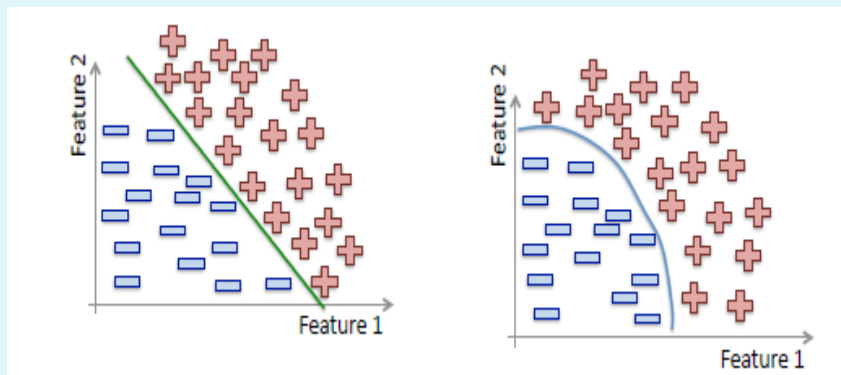

Regression

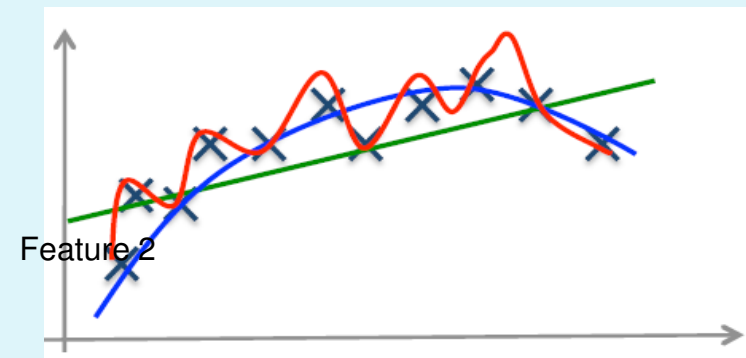

Feature 1

Source: *Machine Learning Basic Concepts* [https://courses.edx.org/asset-1:ColumbiaX+CSMM.101x+1T2017+type@asset+block@AI\\_edx\\_ml\\_5.1intro.pdf](https://courses.edx.org/asset-1:ColumbiaX+CSMM.101x+1T2017+type@asset+block@AI_edx_ml_5.1intro.pdf)



## 4. Cognitive technologies in 5G slicing M&C



### 4.3 Machine Learning (ML) – summary (cont'd)

- **Variants of supervised learning algorithms**
  - **k-Nearest Neighbors (k-NN)** - can be used for classification and regression
    - k-NN is a non-linear method where the input consists of training samples in the input space (labeled)
    - an *Euclidian distance is defined*
    - a new data point (sample) is classified by considering *the majority vote of the labels of its k- nearest neighbors*
  - **Generalized Linear Models (GLM)**- it describes a linear relationship between the output and one or more input variables
  - **Naive Bayes (NB)** - used for classification and is based on Bayes theorem, i.e., calculating probabilities based on the prior probability. The main task is to classify new data points as they arrive



## 4. Cognitive technologies in 5G slicing M&C



### 4.3 Machine Learning (ML) –summary (cont'd)

- **Variants of supervised learning algorithms** (cont'd)
- **Support Vector Machines (SVMs)** - are inspired by statistical learning theory for estimating multidimensional functions
  - Math. optimization problem, solvable by known techniques
  - **Problem:** given  $m$  training samples  $((x_1; y_1); \dots; (x_m; y_m))$ , the goal is to learn the parameters of a function which best fit the data
- **Artificial Neural Network (ANN)** is a statistical learning model where the interconnected nodes represent the neurons producing appropriate responses
  - The basic idea is to efficiently train and validate a neural network. Then, the trained network is used to make a prediction on the test set
- **Decision Trees (DT)** is a flow-chart model in which
  - each internal node represents a test on an attribute
  - each leaf node represents a response
  - branch represents the outcome of the test
- **Usage examples for SVM, ANN, DT:** *classification and regression*



## 4. Cognitive technologies in 5G slicing M&C



### 4.3 Machine Learning (ML) – summary (cont'd)

- **Variants of supervised learning algorithms** (cont'd)
  - **Similarity learning** - closely related to regression and classification
    - Goal: learning from examples, using a *similarity function* that measures how similar or related two objects are
    - Applications examples: ranking, recommendation systems, visual identity tracking, face/speaker verification



## 4. Cognitive technologies in 5G slicing M&C



### 4.3 Machine Learning (ML) – summary (cont'd)

- **Example 1 of ML: Supervised learning**
- ***k*-Nearest Neighbors (*k*-NN) – simple method**
  - **Assumption:** the features used to describe the domain points are relevant to their labeling in a way that makes close-by (Euclidian distance) points likely to have the same label
- *k*-NN figures out a label on any test point without searching for a predictor within some predefined class of functions
- Idea:
  - memorize the training set, then
  - **predict the label of any *new instance/data\_point* on the basis of the labels of its closest neighbors in the training set**
    - a new *data\_point* is classified by a majority vote of its *k*-nearest neighbors

Source: S. Shalev-Shwartz and S. Ben-David, *Understanding Machine Learning: From Theory to Algorithms* 2014, Cambridge University Press



## 4. Cognitive technologies in 5G slicing M&C



### 4.3 Machine Learning (ML) – summary (cont'd)

- **Example 1 of ML: Supervised learning (cont'd)**

- ***k*-Nearest Neighbors (*k*-NN) – classification example**

- Let it be an instance domain,  $X$  and “points”  $x \in \mathcal{X}$   $\mathcal{X} = \mathbb{R}^d$

- Define : Euclidean distance,  $\rho(x, x') = \|x - x'\| = \sqrt{\sum_{i=1}^d (x_i - x'_i)^2}$

- Let  $S = (x_1, y_1), \dots, (x_m, y_m)$  be a sequence of training examples.

let  $\pi_1(x), \dots, \pi_m(x)$  be a reordering of  $\{1, \dots, m\}$   $\rho(x, x_{\pi_i(x)}) \leq \rho(x, x_{\pi_{i+1}(x)})$

*k*-NN

input: a training sample  $S = (x_1, y_1), \dots, (x_m, y_m)$

output: for every point  $x \in \mathcal{X}$ ,

return the majority label among  $\{y_{\pi_i(x)} : i \leq k\}$

#### Example

Classification of the test **Star** point :

$K=3 \rightarrow$  Class B

$K=6 \rightarrow$  Class A

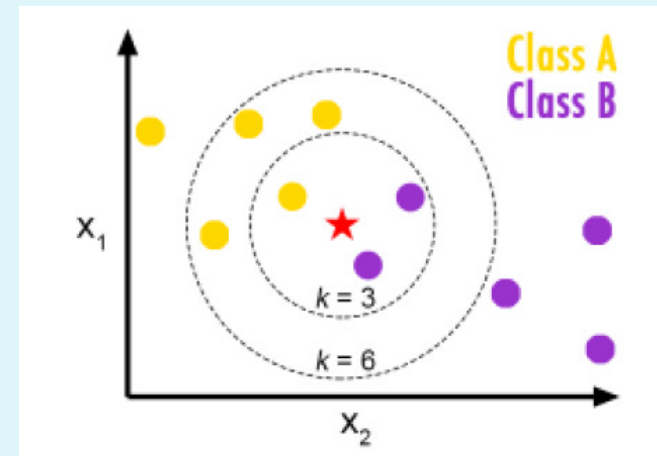

Source: S. Shalev-Shwartz and S. Ben-David, *Understanding Machine Learning: From Theory to Algorithms* 2014, Cambridge University Press

InfoWare 2019 Conference, June 30 - July 04, Rome



## 4. Cognitive technologies in 5G slicing M&C



### 4.3 Machine Learning (ML) – summary (cont'd)

- **Example 1 of ML: Supervised learning**
- ***k-Nearest Neighbors (k-NN) – (cont'd)***
- k-NN can be also used for regression applications
- **Pros:**
  - Simple to implement
  - Works well in practice
  - Does not require to build a model, make assumptions, tune parameters
  - Can be extended easily with news examples
- **Cons:**
  - Requires large space to store the entire training dataset.
  - Slow! Given  $n$  examples and  $d$  features. The method takes  $O(n \times d)$  to run
  - Dimensionality problem

## 4.3 Machine Learning (ML) – summary (cont'd)

- **Example 2 of ML: (Artificial) Neural Networks (ANN) – summary**
  - ANN - computational model inspired by the biological neural networks in the human brain
  - The basic unit of computation: **neuron (node)**
  - The node applies an activation (non-linear) function  $f$  to the weighted sum of its inputs (including a bias)
    - The **bias** provides every node with a trainable constant value (in addition to the normal inputs)

### Examples of activation functions

**Sigmoid:**  $\sigma(x) = 1 / (1 + \exp(-x))$

**tanh:**  $\tanh(x) = 2\sigma(2x) - 1$

**ReLU:** Rectified Linear Unit.  $f(x) = \max(0, x)$

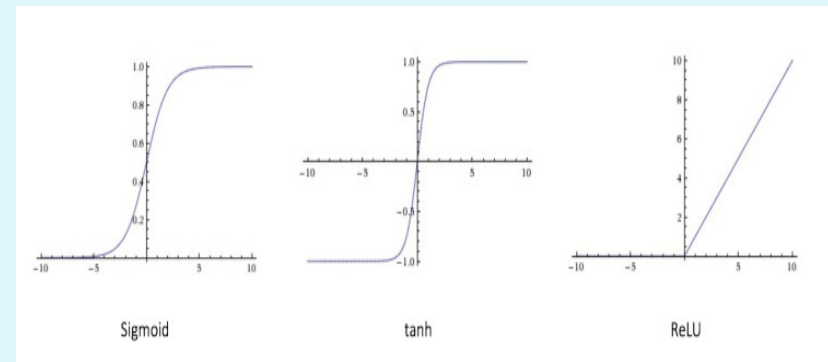
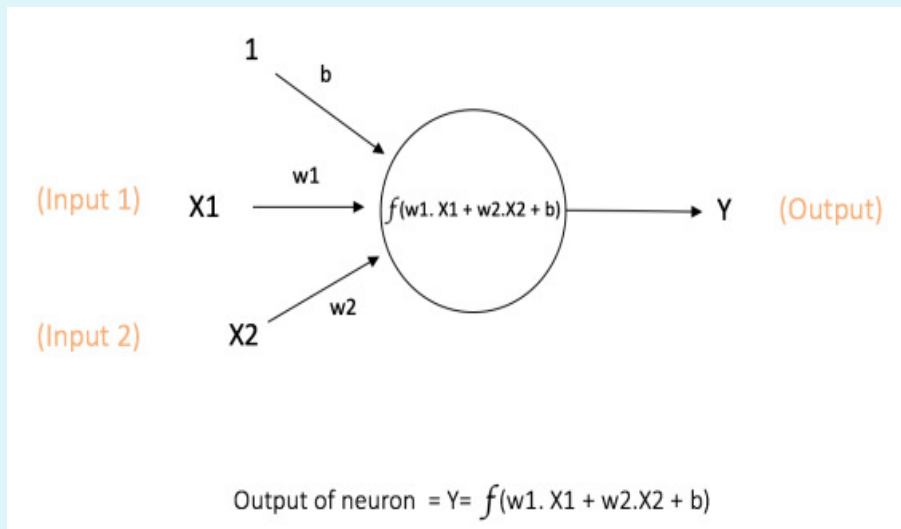



## 4.3 Machine Learning (ML) – summary (cont'd)

- Example 2 of ML: Artificial Neural Networks (ANN) – summary (cont'd)
- Feed-forward Neural Network
  - Simplest type of ANN containing multiple neurons (nodes) arranged in layers
  - **Multi Layer Perceptron (MLP)** –has one or more hidden layers

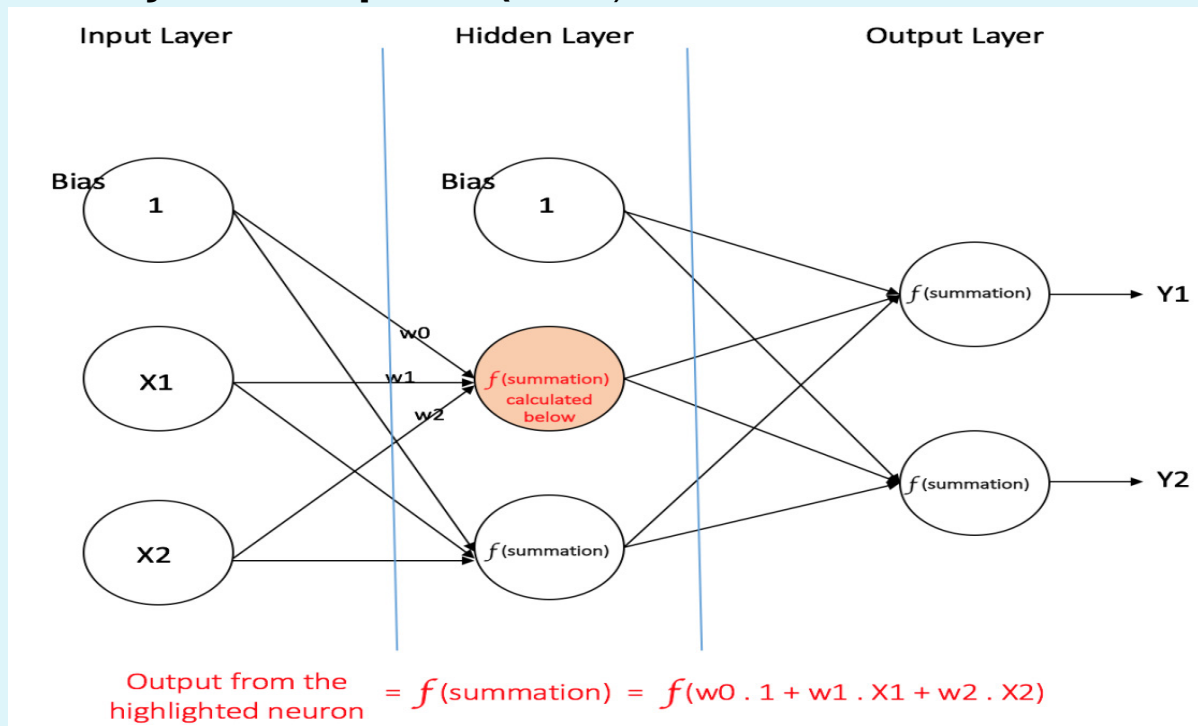

Source: Ujjwalkarn, A Quick Introduction to Neural Networks, <https://ujjwalkarn.me/2016/08/09/quick-intro-neural-networks/>, 2016

InfoWare 2019 Conference, June 30 - July 04, Rome



## 4. Cognitive technologies in 5G slicing M&C



### 4.3 Machine Learning (ML) – summary (cont'd)

- **Example 2 of ML: Artificial Neural Networks (ANN) – summary (cont'd)**
- **Feed-forward Neural Network**
  - Given a set of features  $X = (x_1, x_2, \dots)$  and a target  $y$ , a MLP can learn the relationship between the features and the target, e.g., for classification or regression
- **Training the MLP: The Back-Propagation (BP) Algorithm**
  - BP of errors - is one way to train an ANN
  - BP is a supervised training scheme
  - Learning a function  $f(X)$  to map given inputs  $X$  to desired outputs  $y$
  - Training with 'labeled' data: each example input  $X(t)$  has a label  $y(t)$  ('correct' output)
  - The error  $E$  between  $f_t(X(t))$  and  $y(t)$  is used to adapt  $f$ 
    - and compute  $f_{t+1}(X)$
    - Method: gradient based adjustment of perceptron weights to correct errors
  - **After training, one can use  $f$  for unlabeled data**



## 4. Cognitive technologies in 5G slicing M&C

### 4.3 Machine Learning (ML) – summary (cont'd)

- **Example 2 of ML: Artificial Neural Networks (ANN) – summary (cont'd)**
- **Convolutional Neural Networks (Deep NN)**
  - **Goal: Increasing the NN running speed**
  - **Layers**
    - *Convolutional layers (CL)*
      - Every neuron has just a very limited number of inputs to the vicinity of a corresponding neuron in the previous layer
      - All neurons in a layer use the same set of weights
    - *Pooling layers (PL)*
      - Neighboring neurons are merged (max, sum, etc.)
  - The fully connected layer (MLP) at the end connects all split components of layers
  - Learning is performed by using back-propagation

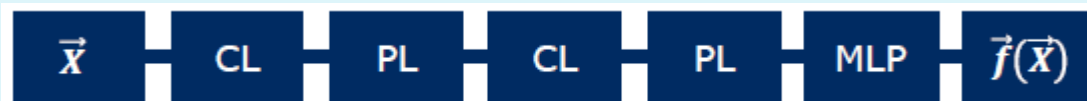

- **Advantage:** large networks can be composed by using these building blocks

Source: J,Quittek, *Artificial Intelligence in Network Operations and Management*,  
<https://networking.ifip.org/2018/images/2018-IFIP-Networking/Keynote-III-J-Quittek-Slides.pdf>

InfoWare 2019 Conference, June 30 - July 04, Rome

### 4.3 Machine Learning (ML) –summary (cont'd)

- **Machine learning methods** (cont'd)
- **Unsupervised learning (UML)**
  - **Objective: to find a pattern in input data**
    - The goal is to construct representation of inputs that can be used for **prediction on future inputs**
    - An algorithm explores input data **without knowing an explicit output correct data** (e.g., explores demographic data to identify patterns)
    - The training set is the unlabeled dataset
    - Usage: at clustering, probability density estimation, finding association among features, dimensionality reduction

Training data: "examples"  $x$ .

$$x_1, \dots, x_n, x_i \in X \subset \mathbb{R}^n$$

- **Clustering/segmentation:**

$$f : \mathbb{R}^d \longrightarrow \{C_1, \dots, C_k\} \text{ (set of clusters).}$$

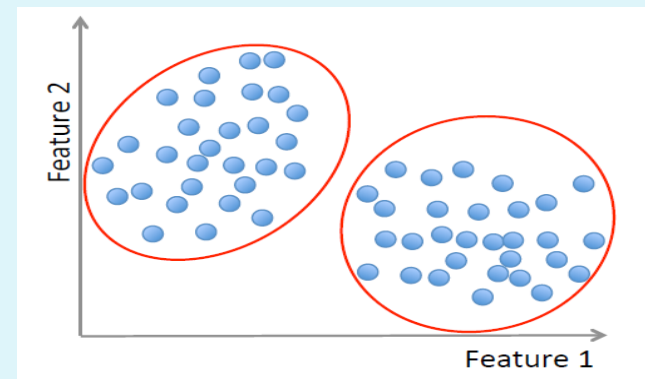

Source: *Machine Learning Basic Concepts* [https://courses.edx.org/asset-1:ColumbiaX+CSMM.101x+1T2017+type@asset+block@AI\\_edx\\_ml\\_5.1intro.pdf](https://courses.edx.org/asset-1:ColumbiaX+CSMM.101x+1T2017+type@asset+block@AI_edx_ml_5.1intro.pdf)



## 4. Cognitive technologies in 5G slicing M&C



### 4.3 Machine Learning (ML) – summary (cont'd)

- **Machine learning methods** (cont'd)
  
- **Unsupervised Machine Learning (UML)**
- **Clustering**
  - Aims at **identifying groups** of data to build representation of the input
  - Methods to create clusters by grouping the data are: non-overlapping, hierarchical and overlapping clustering methods
  - Algorithms: *K-means*, *Self-organizing Maps (SOMs)*, *Fuzzy C-means*, *Gaussian mixture models*
  
- **Dimensionality Reduction**
  - Some problems need: the reduction of the dimension of the original data
  - Common methods:
    - **Feature Extraction (FE)** - e.g., Principal component analysis (PCA)
    - **Feature Selection (FS)** - e.g. Sparse Principal Component Analysis (SPCA)
  - They seek to reduce the number of features in the dataset



## 4. Cognitive technologies in 5G slicing M&C



### 4.3 Machine Learning (ML) – summary (cont'd)

- **Machine learning methods** (cont'd)
- **Unsupervised learning (UML)** (cont'd)
- **Anomaly Detection** - identifies events that do not correspond to an expected pattern. The machine selects the set of unusual events
  - Common methods
    - Rule based systems: (similar to DTs)
    - Pruning techniques: identify outliers, where there are errors in any combination of variables

*Source: Jessica Moysen and Lorenza Giupponi, "From 4G to 5G: Self-organized Network Management meets Machine Learning", arXiv:1707.09300v1 [cs.NI] 28 Jul 2017*

**InfoWare 2019 Conference, June 30 - July 04, Rome**

### 4.3 Machine Learning (ML) –summary (cont'd)

- **Machine learning methods** (cont'd)
- **Reinforced learning (RL)**
- it can be seen as a general-purpose framework for decision-making
  - Software **agents exist able to take actions** in an environment so as to **maximize some notion of cumulative reward**
  - Each action influences the agent's future state
  - Success is measured by a scalar reward signal
  - RL is also is called *approximate dynamic programming*, or *neuro-dynamic programming*

The environment is typically formulated as a **Markov Decision Process (MDP)**, because many RL algorithms for this context utilize dynamic programming techniques

RL do not assume knowledge (in advance) of an exact MDP mathematical model and they target large MDPs, where exact methods become infeasible

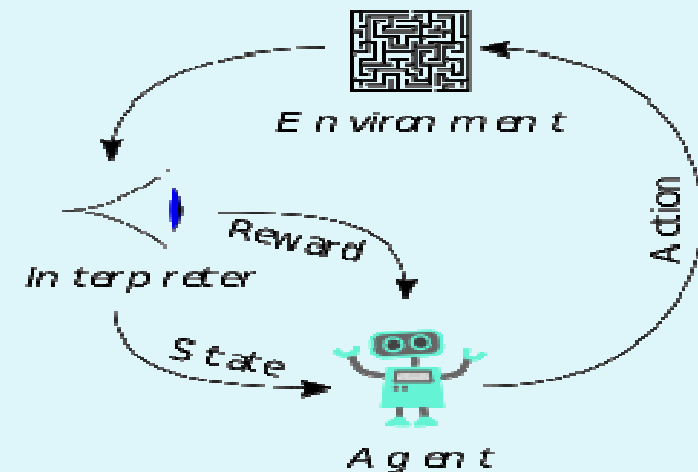



## 4. Cognitive technologies in 5G slicing M&C



### 4.3 Machine Learning (ML) – summary (cont'd)

- **Machine learning methods** (cont'd)
- **Deep Learning (DL)**
- General-purpose framework for *representation* learning
  - Given an objective
    - Learn representation that is required to achieve objective
    - Directly from raw inputs, using minimal domain knowledge
  - **DL use a cascade of *multiple layers* of nonlinear processing units (e.g ANN MLP)** for *feature extraction* and *transformation*. Each successive layer has inputs from the previous layer
  - learn in supervised (e.g., classification) and/or unsupervised (e.g., pattern analysis) manner
  - learn multiple levels of representations that correspond to different levels of abstraction; the levels form a hierarchy of concepts
- **Deep Reinforcement Learning: DRL = RL + DL**
  - **RL defines the objective**
  - **DL gives the mechanism**
  - **RL + DL = general intelligence**





## 4. Cognitive technologies in 5G slicing M&C



### 4.3 Machine Learning (ML) – summary (cont'd)

- **Machine learning methods** (cont'd)
- **Q-learning**
  - It is a *model-free* RL algorithm.
  - Goal: to learn a policy, which tells an agent what action to take under what circumstances
  - It does not require a model (hence the connotation "model-free") of the environment, and it can handle problems with stochastic transitions and rewards



## 4. Cognitive technologies in 5G slicing M&C



### 4.3 Machine Learning (ML) – summary (cont'd)

<b>Supervised Learning</b>	
Classification	K-Nearest Neighbours Generalized Linear Model Support Vector Machines Naive Bayes Neural Networks
Regression	K-Nearest Neighbours Generalized Linear Regression Support Vector Regression Neural Networks Decision Trees
<b>Unsupervised Learning</b>	
Clustering	Non-overlapping clustering Hierarchical clustering Overlapping clustering
Dimensionality Reduction	Feature Extraction Feature Selection
Anomaly Detection	Pruning techniques Rule-based systems
<b>Reinforcement Learning</b>	
Model-based	Dynamic Programming Monte Carlo
Model-free	Temporal Difference

Source: Jessica Moysen and Lorenza Giupponi, "From 4G to 5G: Self-organized Network Management meets Machine Learning", *arXiv:1707.09300v1 [cs.NI]* 28 Jul 2017



## 4. Cognitive technologies in 5G slicing M&C



- **4.4 Machine Learning algorithms –typical use cases**
- **Supervised learning** - used for
  - *regression and classification computation*
    - algorithms: k-NN, neural networks (NN), deep NN
  - *classifications (additional)*
    - algorithms:, Bayesian classifier, support vector machine (SVM)
- **Unsupervised learning-** used for
  - *density estimation*
    - algorithms: Boltzmann machine, Kernel density, Gaussian mixtures
  - *dimensionality reduction*
    - algorithms: auto-associative NN, local linear embedding (LLE)
  - *clustering*
    - algorithms: Spectral clustering, K-means, Principal component analysis
- **Reinforcement learning (RL)** –used for real-time decisions



## 4. Cognitive technologies in 5G slicing M&C



- **4.5 Network functions and relevant (candidates) ML techniques**
  
- **Planning and design**
  - **Functions:**
    - Classification of service requirements
    - Forecasting trend; user behavior
    - Parameters Configuration
  - **ML techniques:** *Support vector machine; Gradient boosting decision tree; Spectral clustering; Reinforcement learning*
  
- **Operation and management**
  - **Functions:**
    - Clustering cells, users, devices
    - Routing, forwarding, traffic control
    - Decision making for dynamic resource control, policy formulation
    - Reconfiguration of parameters
  - **ML techniques:** *K-mean clustering; Deep neural network; Reinforcement learning*



## 4. Cognitive technologies in 5G slicing M&C



- **4.5 Network function and relevant (candidates) ML techniques** (cont'd)
  
- **Monitoring**
  - **Functions:** Clustering of syslog data; Classification of operation modes; Forecasting resource utilization trend
  - **ML techniques :** *Spectral clustering; K-mean clustering; Support vector machine; Deep neural network*
  
- **Fault detection**
  - **Functions:** Classification of operation data; Detection of network anomaly; Predicting unusual behavior
  - **ML techniques:** *Principal component analysis; Independent component analysis; Logistic regression; Bayesian networks*
  
- **Security**
  - **Functions:** Clustering users and devices; Detecting malicious behavior; Intrusion detection
  - **ML techniques:** *Deep neural network; Principal component analysis*



## 4. Cognitive technologies in 5G slicing M&C



### 4.5 Network function and relevant ML techniques

- Specific ML techniques appropriate for FCAPS- Examples

- BN - Bayesian networks
- NN - Neural networks
- K-NN – K Nearest Neighbors
- DT - Decision trees
- DL - Deep Learning
- SVM - Support vector machines
- DNN - Deep NN
- RL - Reinforcement Learning

Management area	Management function	Machine learning techniques
Fault	Fault prediction	NN, k-NN, k-Means, DT, BN, SVM
	Fault localization	NN, k-NN, k-Means, DT
	Automated mitigation	BN, SVM
Configuration	Adaptive resource allocation	Q-Learning, Deep
	Adaptive service configuration	Q-Learning
Accounting	–	–
Performance	Traffic load and metrics prediction	(Ensemble) NN, BN, SVM,
	QoE-QoS correlation	DT, BN, SVM, Q-learning
Security	Misuse detection	NN, DT, BN, SVM
	Anomaly detection	(Ensemble) NN, DNN, k-NN, k-means, (Ensemble) DT, Ensemble BN, SVM

Source: Sara Ayoubi, et.al., *Machine Learning for Cognitive Network Management*, IEEE Comm.Magazine , January 2018, pp.158-165



## 4. Cognitive technologies in 5G slicing M&C

- **4.5 Research challenges related to ML techniques for FCAPS- examples**
- **Failure Prevention:**
  - ML- *Proactive mitigation* (e.g using RL) combined with *fault prediction* can prevent upcoming failures
    - To select the mitigation step, the root cause of the predicted fault has to be identified
    - But, existing ML-based localization approaches: **poor scalability for the high-dimensional device log attributes in moderate-size networks**
    - **Dimensionality reduction is needed**
- **Fault Management in Cloud and Virtualized Environments**
  - The multi-tenancy in cloud/NFV environment raises the complexity and dimensions of the fault space in a network
  - DeepNNs can model complex multi-dimensional state spaces- -- > used to predict and locate faults in such networks
  - Any automated mitigation within a Virtual Network (VN)/slice should not affect other coexisting VNs
    - RL combined with DNNs can learn to optimize mitigation steps

*Adapted from : Sara Ayoubi, et.al., Machine Learning for Cognitive Network Management, IEEE Comm.Magazine , January 2018, pp.158-165*

InfoWare 2019 Conference, June 30 - July 04, Rome



## 4. Cognitive technologies in 5G slicing M&C



- **4.5 Research challenges related to ML techniques for FCAPS (cont'd)**
- **Performance Management**
  - **Adaptive Probing**
    - Large number of devices, parameters, small time intervals to log data → increase the amount of measuring traffic overhead
    - Regression, mostly based on time series data, can predict the value of the measured parameters to optimize probing
    - Objective: to set probing rates that keep traffic overhead enough low, while minimizing performance degradation and providing high prediction accuracy
  - **Detecting Patterns of Degradation**
    - Need to detect the characteristic patterns of degradation before the quality drops below an acceptable level
    - Elastic resource allocation can dynamically accommodate user demands for achieving optimum performance while maximizing resource utilization
    - SML has been already used to predict the value of network perf.
    - However, **employing perf. prediction for autonomic tuning of the network behavior is still a challenge.**

InfoWare 2019 Conference, June 30 - July 04, Rome





## 4. Cognitive technologies in 5G slicing M&C



- **4.5 Research challenges related to ML techniques for FCAPS** (cont'd)
- **Configuration Management:**
  - **Mapping High-Level Requirements to Low-Level Configurations:**
    - There is a gap between high-level slice/services requirements and low-level configurations (e.g., resources to be provisioned)
    - RL techniques can be applied
    - The reward for selecting a configuration setting of a given network element can be seen as the utility of that particular setting in delivering the high-level requirements under a given network condition
  - **Configuration and Verification**
    - Configuration changes (e.g., access control lists, routing tables) should comply with high-level requirements and not adversely affect the expected network behavior
    - Interest exists in applying DL-aided verification, code correction, and theorem proving

Source: Sara Ayoubi, et.al., *Machine Learning for Cognitive Network Management*, IEEE Comm.Magazine , January 2018, pp.158-165

### 4.6 Examples of architectures embedding cognitive management

#### ■ Example 1: MAPE- full cognitive loop

Source: Sara Ayoubi, et.al., *Machine Learning for Cognitive Network Management, IEEE Comm.Magazine*, January 2018, pp.158-165

- Traditional – MAPE: only Analyze Phase included cognitive properties
- **Proposal : to introduce ML in all phases**
- ML: introducing **learning** and **inference** in every function.

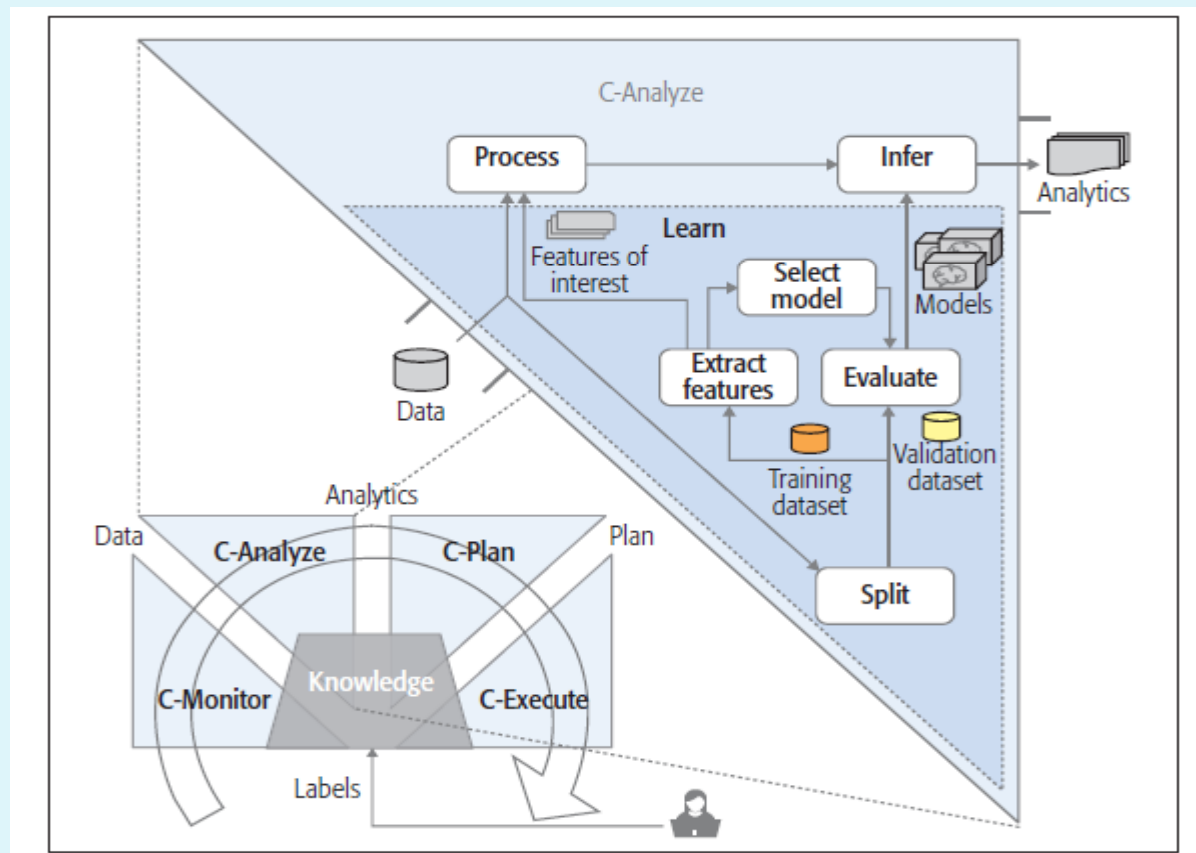

InfoWare 2019 Conference, June 30 - July 04, Rome



## 4. Cognitive technologies in 5G slicing M&C



### 4.6 Examples of architectures embedding cognitive management

- **Example 1: MAPE- full cognitive loop** (cont'd)
- **C-Monitor: intelligent probing** (e.g., if overloaded network the probing rate is reduced and instead perform regression for data prediction)
- **C-Analyze: detects or predicts changes** in the network environment (e.g., faults, policy violations, frauds, low performance, attacks)
- **C-Plan: -use ML to develop an intelligent automated planning (AP) engine** reacting to changes in the network by selecting or composing a change plan
  - **Used in slice updates**
- **C-Execute:** schedules the generated plans; actions to be done in case that execution of a plan fail
  - RL is –naturally- applied: **C-Execute agent** could
    - exploit past successful experiences to generate optimal execution policies
    - explore new actions in case the execution plan fails
- **Closing the control loop** : monitoring the state of the network to measure the impact of the change plan

*Source: Sara Ayoubi, et.al., Machine Learning for Cognitive Network Management, IEEE Comm.Magazine , January 2018, pp.158-165*

**InfoWare 2019 Conference, June 30 - July 04, Rome**

## 4. Advanced cognitive management

### 4.6 Examples of architectures embedding cognitive management

- **Example 2: SLICENET H2020 Phase 2 project** : *End-to-End Cognitive Network Slicing and Slice Management Framework in Virtualized Multi-Domain, Multi-Tenant 5G Networks.* (2016)

- *SLICENET architectural vision*

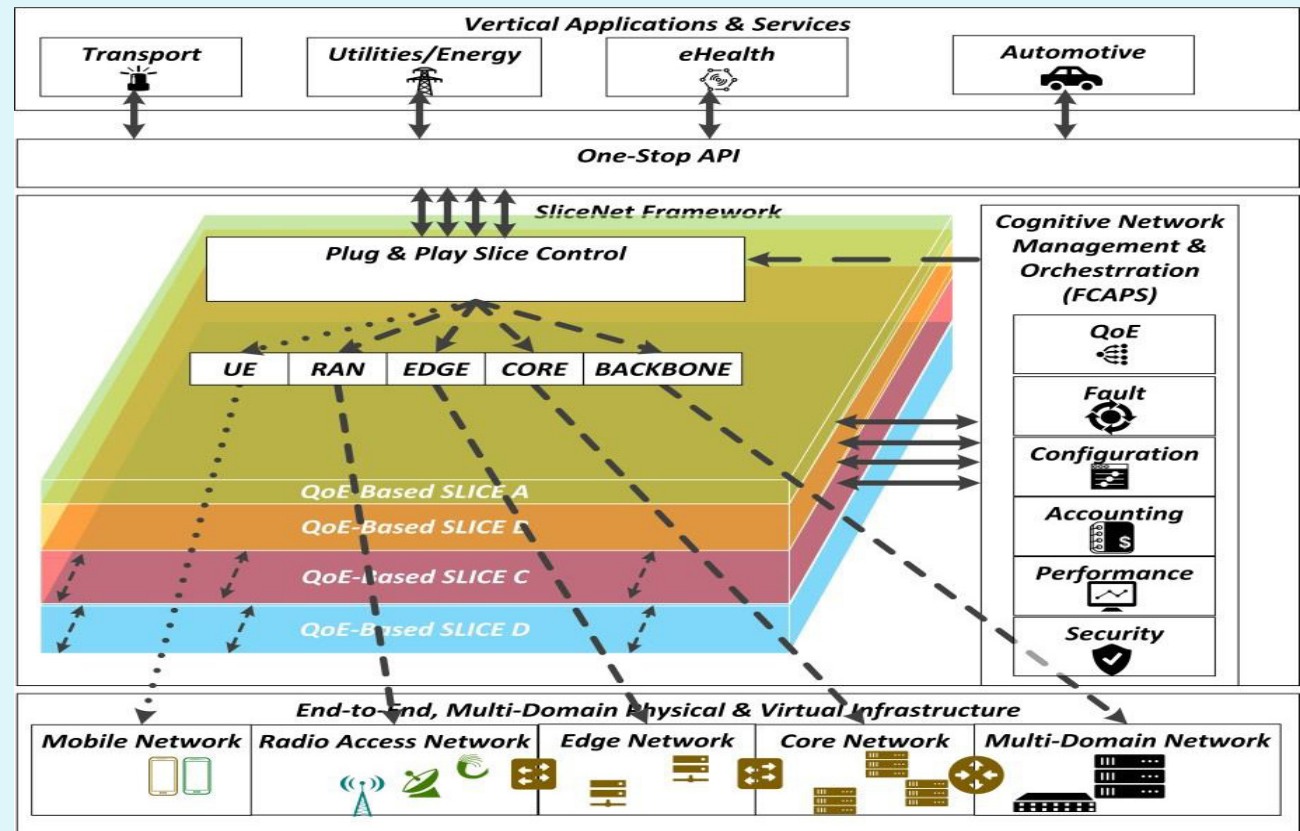

Source: <https://5g-ppp.eu/slicenet>

InfoWare 2019 Conference, June 30 - July 04, Rome

### 4.6 Examples of architectures embedding cognitive management

- **Example 2: SLICENET H2020 Phase 2 project** (cont'd)
- SliceNet mgmt. : “**verticals in the whole loop**” approach, integrating the vertical perspective into the slice management process
- SliceNet: fully automated slice M&O through AI/ML and utilizing the autonomous computing MAPE loop model, a vertically-informed multilayer QoE monitoring sub-plane, and a slice-centric policy framework.
- The vertical is integrated into the CogM process by providing
  - the perceived QoE: it enables *supervised ML* methods.
  - context: used to collect context-aware cross-layer information

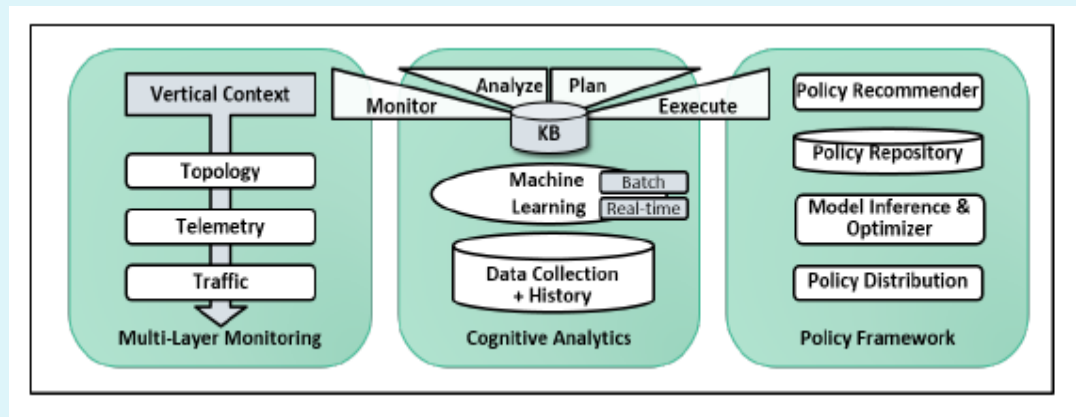

Source: D. Lorenz, et. al., “SliceNet – Cognitive Slice Management Framework for Virtual Multi-Domain 5G Networks”, <https://www.systor.org/2018/pdf/systor18-21.pdf>



## 4. Cognitive technologies in 5G slicing M&C



### 4.6 Examples of architectures embedding cognitive management

- **Example 3: 5G Network Slice Broker**
- **Problem solved:** *mapping heterogeneous service requirements onto the available network resource*
  - **5G Network Slice Broker (SB)**- mediator between external tenants and mobile network management
- Slice management and SB should meet some 3GPP Slicing requirements
  - **Network Slice Templates (NSTs)** are available for different services
  - Each NST includes own SLAs
  - The **Broker**: Receive NSL requests from tenants through a Network Exposure Function (NEF)
  - SB performs **Admission Control (AC)** based-on Slice Request NSTs
  - Use NG2 interfaces to monitor KPIs and configure network slice on RAN facilities

Source: V.Sciancalepore, K.Samdanis, et al., *Mobile Traffic Forecasting for Maximizing 5G Network Slicing Resource Utilization*, Infocom 2017, [http://www.sciancalepore.info/files/infocom2017\\_ssc.pdf](http://www.sciancalepore.info/files/infocom2017_ssc.pdf)

J,Quittek, *Artificial Intelligence in Network Operations and Management*, <https://networking.ifip.org/2018/images/2018-IFIP-Networking/Keynote-III-J-Quittek-Slides.pdf>

InfoWare 2019 Conference, June 30 - July 04, Rome



## 4. Cognitive technologies in 5G slicing M&C



### 4.6 Examples of architectures embedding cognitive management

- **Example 3: 5G Network Slice Broker** (cont'd)
- **Slice Broker concepts and architecture**
  - NSL requests are collected within a fixed negotiation time window
  - then the time window is closed, and slice requests are processed
- **Admission Control (AC)** is necessary (considering the available resources and SLA request)
- Prediction of the tenants' traffic evolution in the near future increases the efficiency
- **Slice Forecasting Module (SFM)** analyzes the network slices traffic patterns and provides information to the AC
  - **Machine Learning can be used in SFM**
  - If no forecasting is applied or during the ML training period the only information used are the SLA requests

Source: V.Sciancalepore, K.Samdanis, et al., *Mobile Traffic Forecasting for Maximizing 5G Network Slicing Resource Utilization*, *Infocom 2017*, [http://www.sciancalepore.info/files/infocom2017\\_ssc.pdf](http://www.sciancalepore.info/files/infocom2017_ssc.pdf)

J,Quittek, *Artificial Intelligence in Network Operations and Management*, <https://networking.ifip.org/2018/images/2018-IFIP-Networking/Keynote-III-J-Quittek-Slides.pdf>





## 4. Cognitive technologies in 5G slicing M&C



### 4.6 Examples of architectures embedding cognitive management

- **Example 3: 5G Network Slice Broker** (cont'd)
- **Slice Broker concepts and architecture** (cont'd)
  - Different AC policies and algorithms can be used to select which NSL requests will be granted for the next time window
  - The list of granted slice requests is sent to the **Slice Scheduling Module**
    - SSM allocates NSL physical resources and monitors (with a penalty history function) the served traffic levels and potential SLA violations
- Feedback is provided to the forecasting module for adaptive behaviour
- **Slice Broker architecture - functional blocks**
  - Slice forecasting
  - Admission Control
  - Slice scheduling

Source: V.Sciancalepore, K.Samdanis, et al., *Mobile Traffic Forecasting for Maximizing 5G Network Slicing Resource Utilization*, *Infocom 2017*, [http://www.sciancalepore.info/files/infocom2017\\_ssc.pdf](http://www.sciancalepore.info/files/infocom2017_ssc.pdf)

J,Quittek, *Artificial Intelligence in Network Operations and Management*, <https://networking.ifip.org/2018/images/2018-IFIP-Networking/Keynote-III-J-Quittek-Slides.pdf>

InfoWare 2019 Conference, June 30 - July 04, Rome



### 4.6 Examples of architectures embedding cognitive management

- **Example 3: 5G Network Slice Broker** (cont'd)
  - Slice Broker architecture
  - ML- applicable mainly for traffic forecasting (but not only)

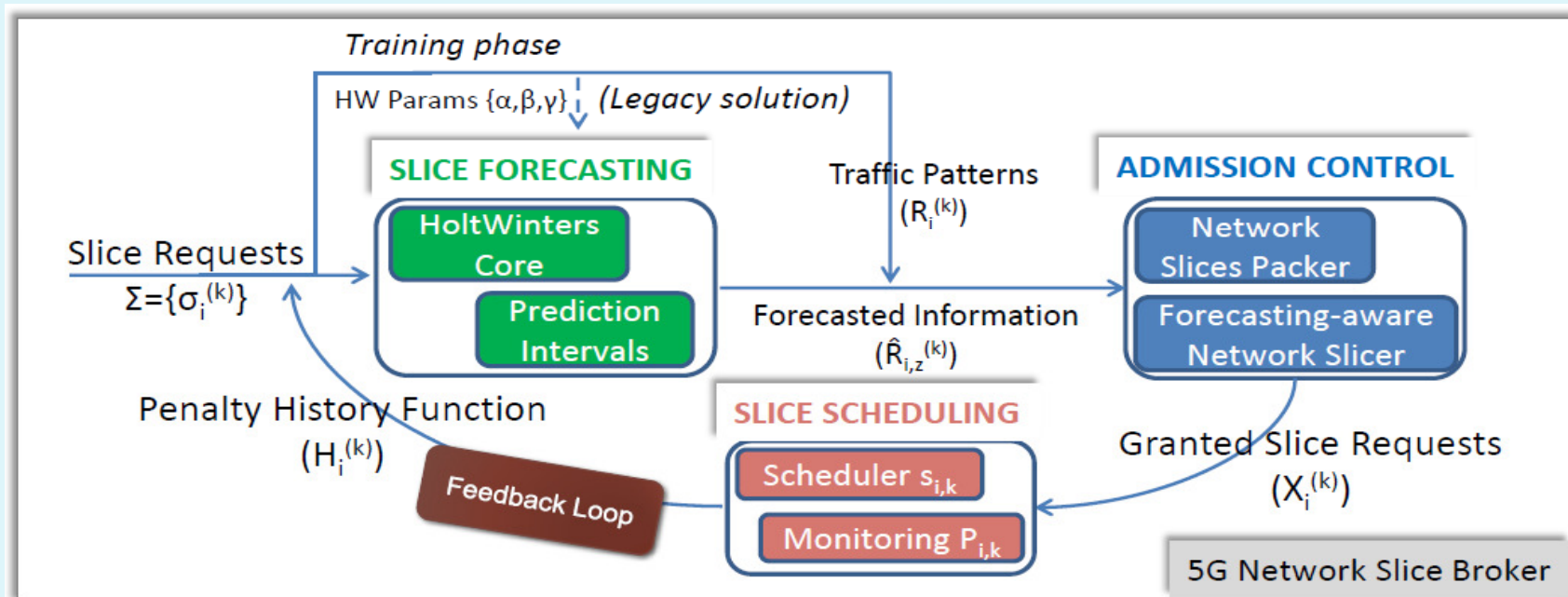

Source: V.Sciancalepore, K.Samdanis, et al., *Mobile Traffic Forecasting for Maximizing 5G Network Slicing Resource Utilization*, Infocom 2017, [http://www.sciancalepore.info/files/infocom2017\\_ssc.pdf](http://www.sciancalepore.info/files/infocom2017_ssc.pdf)

J,Quittek, *Artificial Intelligence in Network Operations and Management*, <https://networking.ifip.org/2018/images/2018-IFIP-Networking/Keynote-III-J-Quittek-Slides.pdf>

InfoWare 2019 Conference, June 30 - July 04, Rome



# CONTENTS

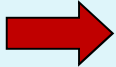

1. Introduction
2. 5G slicing relevant architectures
3. Management, orchestration and control
4. Cognitive technologies in 5G slicing M&C
5.  **Conclusions and research challenges**



## 5. Conclusions and research challenges



- **Challenges in Using Machine Learning**
  - Representative Datasets
  - Speed vs. accuracy
  - Ground truth (refers to the accuracy of the training set's classification for SML techniques)
  - Incremental Learning
  - Security of Machine Learning
  
- **Challenges in Autonomic Network Management in cognitive context**
  - Orchestration of Cognitive Management Functions
  - Cooperation between Cognitive Mgmt and SDN, NFV environment
  - Selection of the most convenient ML techniques for 5G M&C



# Cognitive Technologies in 5G Slicing Management and Control

---



- Thank you !
- Questions?



# Cognitive Technologies in 5G Slicing Management and Control



## References

1. Panwar N., Sharma S., Singh A. K. 'A Survey on 5G: The Next Generation of Mobile Communication' Elsevier Physical Communication, 4 Nov 2015, <http://arxiv.org/pdf/1511.01643v1.pdf>
2. 5GPPP Architecture Working Group , View on 5G Architecture, Version 2.0, December 2017
3. 3GPP TS 23.501 V15.2.0 (2018-06), System Architecture for the 5G System; Stage 2, (Release 15)
4. 3GPP TS 28.530 V1.2.1 (2018-07), Management and orchestration of 5G networks; Concepts, use cases and requirements
5. 3GPP, TR 23.799 V14.0.0 (2016-12), Study on Architecture for Next Generation System (Release 14)
6. 3GPP TR 28.801 V15.1.0 (2018-01), Study on management and orchestration of network slicing for next generation network, (Release 15)
7. A.Galis, 5G Architecture Viewpoints H2020 5G PPP Infrastructure Association July 2016, August 2017, <https://5g-ppp.eu/white-papers/>
8. A. Galis, Towards Slice Networking, presentation at IETF98 -, March 2017; <https://github.com/netslices/IETF-NetSlices>
9. A.Galis, "Network Slicing - Management Challenges", IRTF 102 – NMRG, 2018
10. J. Ordonez-Lucena, P. Ameigeiras, D. Lopez, J.J. Ramos-Munoz, J. Lorca, J. Folgueira, Network "Slicing for 5G with SDN/NFV: Concepts, Architectures and Challenges" , IEEE Communications Magazine, 2017, Citation information: DOI 10.1109/MCOM.2017.1600935
11. ONF TR-526, "Applying SDN Architecture to 5G Slicing", Apr. 2016.
12. ETSI GS NFV 003 V1.2.1 (2014-12), Network Functions Virtualisation (NFV);Terminology for Main Concepts in NFV, [http://www.etsi.org/deliver/etsi\\_gs/NFV/001\\_099/003/01.02.01\\_60/gs\\_NFV003v010201p.pdf](http://www.etsi.org/deliver/etsi_gs/NFV/001_099/003/01.02.01_60/gs_NFV003v010201p.pdf)
13. ETSI NFV 001 V1.1.1, 2013-10, NFV Use Cases
14. ETSI GS NFV 002 v1.2.1 2014-12, NFV Architectural Framework
15. IETF Network Slicing Architecture draft-geng-netslices-architecture-02,
16. ETSI GR NFV-EVE 012 V3.1.1 (2017-12), Release 3; NFV Evolution and Ecosystem; Report on Network Slicing Support with ETSI NFV Architecture Framework
17. ETSI EN 302 665 V1.1.1 (2010-09, European Standard (Telecommunications series) Intelligent Transport Systems (ITS); Communications Architecture
18. ETSI GS NFV 003 V1.3.1 (2018-01) Network Functions Virtualisation (NFV); Terminology for Main Concepts in NFV

**InfoWare 2019 Conference, June 30 - July 04, Rome**



# Cognitive Technologies in 5G Slicing Management and Control



## References

19. ETSI GR NFV-IFA 022 V3.1.1 (2018-04) Network Functions Virtualisation (NFV) Release 3; Management and Orchestration; Report on Management and connectivity for Multi-Site Services
20. ONF TR 527: "Functional Requirements for Transport API", June 2016.
21. Q. Li, G. Wu, A. Papathanassiou, U. Mukherjee , An end-to-end network slicing framework for 5G wireless communication systems, <https://arxiv.org/abs/1608.00572>
22. GSMA, Network Slicing, - Use Cases and Requirements , April 2018, <https://www.gsma.com/futurenetworks/wp-content/uploads/2018/04/NS-Final.pdf>
23. 5G Americas, Network Slicing for 5G Networks & Services, 2016, [http://www.5gamericas.org/files/3214/7975/0104/5G\\_Americas\\_Network\\_Slicing\\_11.21\\_Final.pdf](http://www.5gamericas.org/files/3214/7975/0104/5G_Americas_Network_Slicing_11.21_Final.pdf)
24. K.Katsalis, N.Nikaein, Andy Edmonds, Multi-Domain Orchestration for NFV: Challenges and Research Directions, [2016 15th International Conference on Ubiquitous Computing and Communications and 2016 International Symposium on Cyberspace and Security \(IUCC-CSS\)](https://doi.org/10.1109/IC3EAT.2016.7828601), <https://ieeexplore.ieee.org/document/7828601>
25. Z.Kotulski et.al., Towards constructive approach to end-to-end slice isolation in 5G networks, EURASIP Journal on Information Security (2018) 2018:2, <https://doi.org/10.1186/s13635-018-0072-0>
26. X. Foukas, G. Patounas, A.Elmokashfi, and M.K. Marina, Network Slicing in 5G: Survey and Challenges, IEEE Communications Magazine, May 2017, pp.94-100
27. P. Rost et al, Network Slicing to Enable Scalability and Flexibility in 5G Mobile Networks, IEEE Communication Magazine, 2017
28. G. Nencioni et al., Orchestration and Control in Software-Defined 5G Networks: Research Challenges, Wiley, Wireless Communications and Mobile Computing Volume 2018, Article ID 6923867, pp. 1-19, <https://doi.org/10.1155/2018/6923867><https://www.hindawi.com/journals/wcmc/2018/6923867/>
29. End to End Network Slicing – White paper 3 Outlook 21, Wireless World , Nov 2017
30. Jinjin Gong, Lu Ge, Xin Su, Jie Zeng, Radio Access Network Slicing in 5G, in Advances in Intelligent Systems and Computing · March 2017 , <https://www.researchgate.net/publication/315848047>
31. Ibrahim AFOLABI, et al., Towards 5G Network Slicing over Multiple-Domains, IEICE Trans. Commun., Vol.E100–B, No.11 Nov. 2017



# Cognitive Technologies in 5G Slicing Management and Control



## References

32. L. Geng , et.al., IETF- “Network Slicing Architecture draft-geng-netslices-architecture-02”, 2017
33. A.Galis and K.Makhijani, Network Slicing Landscape: A holistic architectural approach, orchestration and management with applicability in mobile and fixed networks and clouds, v1.0, Network Slicing Tutorial – IEEE NetSoft 2018 – Montreal 29th June 2018.
34. Ibrahim Afolabi, Tarik Taleb , Konstantinos Samdanis, Adlen Ksentini, and Hannu Flinck, Network Slicing and Softwarization: A Survey on Principles, Enabling Technologies, and Solutions IEEE Comm. Surveys & Tutorials, Vol. 20, No. 3, 2018
35. J.Ordonez-Lucena, et.al., "The Creation Phase in Network Slicing: From a Service Order to an Operative Network Slice", European Conference on Networks and Communications (EuCNC), 2018, <https://arxiv.org/abs/1804.09642>
36. T.Taleb, I.Afolabi, K.Samdanis, and F. Z.Yousaf, "On Multi-domain Network Slicing Orchestration Architecture & Federated Resource Control", <http://mosaic-lab.org/uploads/papers/3f772f2d-9e0f-4329-9298-aae4ef8ded65.pdf>
37. 5GPPP Network Management & Quality of Service Working Group, “Cognitive Network Management for 5G”, 2017
38. V. P. Kafle, et. al., “Consideration on Automation of 5G Network slicing with Machine Learning” , ITU Kaleidoscope Santafe 2018
39. “Machine Learning Tutorial for Beginners”, <https://www.guru99.com/machine-learning-tutorial.html>
40. Machine Learning Basic Concepts [https://courses.edx.org/asset-1:ColumbiaX+CSMM.101x+1T2017+type@asset+block@AI\\_edx\\_ml\\_5.1intro.pdf](https://courses.edx.org/asset-1:ColumbiaX+CSMM.101x+1T2017+type@asset+block@AI_edx_ml_5.1intro.pdf)
41. Wei-Lun Chao, Machine Learning Tutorial, 2011, <http://disp.ee.ntu.edu.tw/~pujols/Machine%20Learning%20Tutorial.pdf>
42. Jessica Moysen and Lorenza Giupponi, “From 4G to 5G: Self-organized Network Management meets Machine Learning”, arXiv:1707.09300v1 [cs.NI] 28 Jul 2017
43. Sara Ayoubi, et.al., Machine Learning for Cognitive Network Management, IEEE Comm.Magazine , January 2018, pp.158-165
44. <https://5g-ppp.eu/slicenet>
45. D. Lorenz, et. al., “SliceNet – Cognitive Slice Management Framework for Virtual Multi-Domain 5G Networks”, <https://www.systor.org/2018/pdf/systor18-21.pdf>

InfoWare 2019 Conference, June 30 - July 04, Rome



# Cognitive Technologies in 5G Slicing Management and Control



## References

46. S. Shalev-Shwartz and S. Ben-David, Understanding Machine Learning: From Theory to Algorithms 2014, Cambridge University Press
47. N. Dupuis, K. Lee, Introduction to Machine Learning, <https://www.phusewiki.org/docs/Frankfurt%20Connect%202018/ML/Papers/ML17-phuse-paper-ml01-19265.pdf>
48. J. Quittek, Artificial Intelligence in Network Operations and Management, <https://networking.ifip.org/2018/images/2018-IFIP-Networking/Keynote-III-J-Quittek-Slides.pdf>
49. R. Johansson, Applied Machine Learning Lecture 1: Introduction, Univ. of Gothenburg, 2019, <http://www.cse.chalmers.se/~richajo/dit866/lectures/l1/l1.pdf>
50. Ujjwalkarn, A Quick Introduction to Neural Networks, <https://ujjwalkarn.me/2016/08/09/quick-intro-neural-networks/>, 2016
51. V. Sciancalepore, K. Samdanis, et al., Mobile Traffic Forecasting for Maximizing 5G Network Slicing Resource Utilization, Infocom 2017, [http://www.sciancalepore.info/files/infocom2017\\_ssc.pdf](http://www.sciancalepore.info/files/infocom2017_ssc.pdf)





# Cognitive Technologies in 5G Slicing Management and Control



- List of Acronyms

5G CN	Core Network
5G-AN	5G Access Network
5GS	5G System
AF	Application Function
AI	Artificial Intelligence
AMF	Access and Mobility Management Function
AS	Access Stratum
BBU	Baseband Unit
BN	Bayesian Networks
CA	Certificate Authority
CaaS	Cooperation as a Service
CC	Cloud Computing
CP	Control Plane
CRAN	Cloud based Radio Access Network
D2D	Device to Device communication
DLk	Downlink
DL	Deep Learning
DN	Data Network
DNN	Deep Neural Network
DoS	Denial of Services
DP	Data Plane (User Plane UP)



# Cognitive Technologies in 5G Slicing Management and Control



- List of Acronyms

DT	Decision Tree
ENaaS	Entertainment as a Service
ePDG	evolved Packet Data Gateway
FC	Fog Computing
IaaS	Infrastructure as a Service
INaaS	Information as a Service
IoT	Internet of Things
IT&C	Information Technology and Communications
k-NN	k-Nearest Neighbours
LADN	Local Area Data Network
LLC	Logical Link Control
LMF	Location Management Function
MANET	Mobile Ad hoc Network
M&C	Management and Control
MCC	Mobile Cloud Computing
MEC	Multi-access (Mobile ) Edge Computing
ML	Machine Learning
N3IWF	Non-3GPP InterWorking Function
NaaS	Network as a Service
NAI	Network Access Identifier



# Cognitive Technologies in 5G Slicing Management and Control



- List of Acronyms

NEF	Network Exposure Function
NF	Network Function
NFV	Network Function Virtualization
NGAP	Next Generation Application Protocol
NN	Neural Networks
NRF	Network Repository Function
NSL	Network Slice
NSLI	Network Slice Instance
NS	Network Service
NSLID	Network Slice Instance Identifier
NSSAI	Network Slice Selection Assistance Information
NSSF	Network Slice Selection Function
NSSP	Network Slice Selection Policy
NWDAF	Network Data Analytics Function
OIF	Optical Internetworking Forum
ONF	Open Networking Foundation
PaaS	Platform as a Service
PCF	Policy Control Function
PEI	Permanent Equipment Identifier
PKI	Public Key Infrastructure
QoE	Quality of Experience
RAN	Radio Access Network



# Cognitive Technologies in 5G Slicing Management and Control



- List of Acronyms

RL	Reinforcement Learning
SaaS	Software as a Service
SBA	Service Based Architecture
SD	Slice Differentiator
SDN	Software Defined Networking
SEAF	Security Anchor Functionality
SEPP	Security Edge Protection Proxy
SLA	Service Level Agreement
SM	Service Management
SMF	Session Management Function
SML	Supervised Machine Learning
S-MIB	Security Management Information Base
SMSF	Short Message Service Function
S-NSSAI	Single Network Slice Selection Assistance Information
SSC	Session and Service Continuity
SST	Slice/Service Type
SVM	Support Vector Machine
TNL	Transport Network Layer
TNLA	Transport Network Layer Association
TSP	Traffic Steering Policy



# Cognitive Technologies in 5G Slicing Management and Control



- **List of Acronyms**

UDM	Unified Data Management
UDR	Unified Data Repository
UML	Unsupervised Machine Learning
UL	Uplink
UPF	User Plane Function
V2X	Vehicle-to-everything
VANET	Vehicular Ad hoc Network
VID	VLAN Identifier
VLAN	Virtual Local Area Network
VM	Virtual Machine
WAT	Wireless Access Technologies
WSN	Wireless Sensor Network



# Cognitive Technologies in 5G Slicing Management and Control

---



- **Backup slides**



# BS1 Standardisation work oriented to slicing



- **European Telecom Std. Institute (ETSI) –Next Generation Protocols (NGP) –** Technology independent approach to slicing
  - **ETSI- Network Function Virtualization (NFV )–** studies on SDN and NFV support for slices
- **3rd Generation Partnership Project (3GPP)** – contributions on RAN, Services and architectures, Core networks and terminals, Mgmt. and orchestration
- **5G-PPP** – details the roles and relationships between different parts of the 5G network.
- **Next Generation Mobile Networks (NGMN)** –Slicing concept for 5G with IMT2020
- **Int’l Telecom Union (ITU-T)** – Works on Slices in IMT-2020, SG13 and SG15: management & transport aspects; alignment with 5G
- **Open Networking Foundation (ONF) , Broadband Forum (BBF)**
- **Internet Engineering Task Force (IETF)** – focused more on fixed network and management of network slicing
- **GSM Association (GSMA)-** business aspects, use cases, etc.



# BS1 Standardisation work oriented to slicing

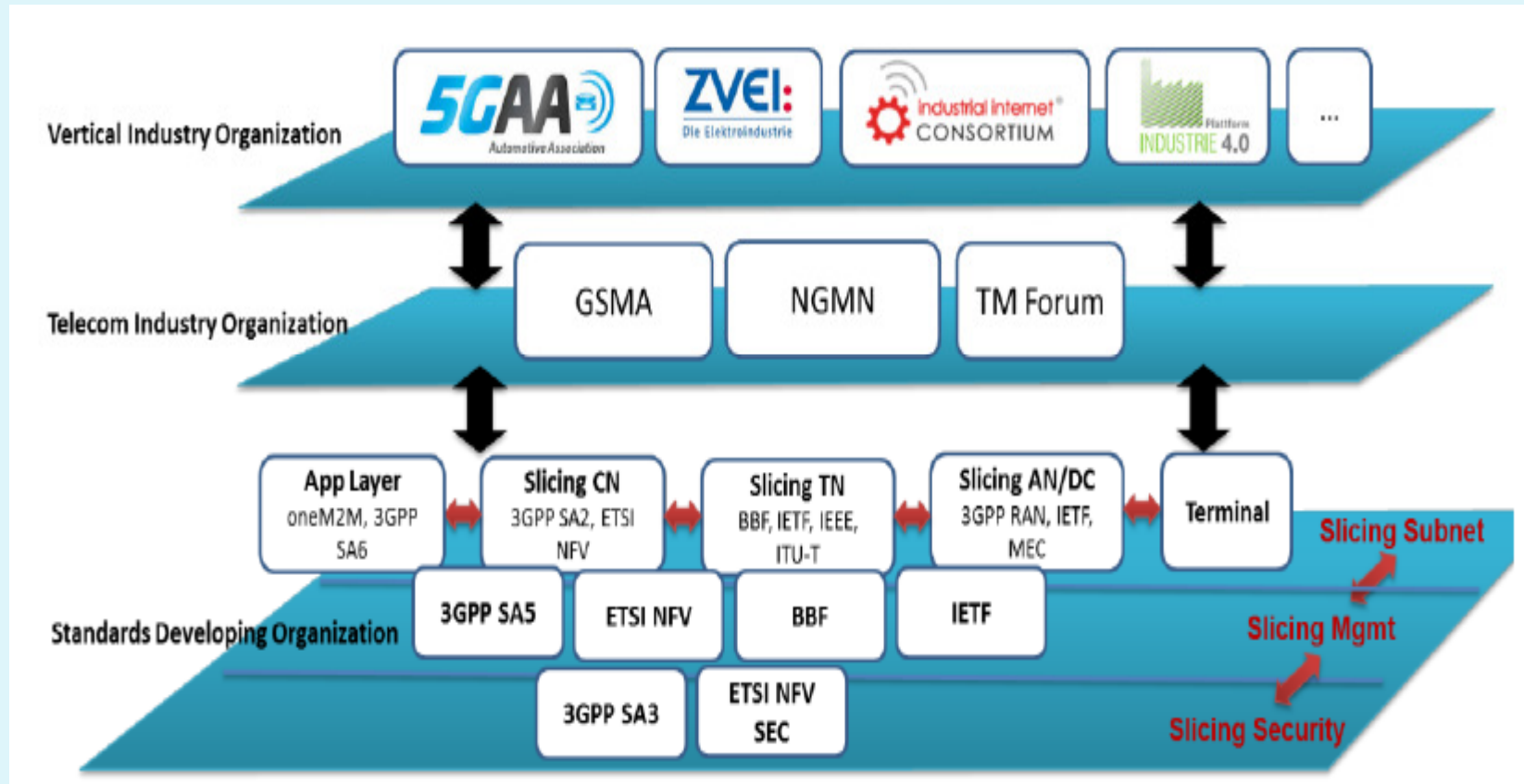

Source: GSMA, Network Slicing, - Use Cases and Requirements , April 2018

InfoWare 2019 Conference, June 30 - July 04, Rome



- SDN and NFV- complementary

