

Beyond WiFi-based Wireless Sensor Networks

Dr. Sandra Sendra Compte



UNIVERSIDAD
DE GRANADA

1.- University of Granada

2.- Research Group

3.- Wireless Sensor Networks (WSNs)

4.- The new concept of WSNs for IoT - LoRa for IoT

5.- Hardware for IoT

WiFi-based Hardware for IoT

LoRa-based Hardware for IoT

6.- IoT Applications

Acknowledgment



UNIVERSIDAD DE GRANADA

UNIVERSITY OF GRANADA



- [University of Granada \(UGR\)](#) is a public educational institution that offers modern and flexible degrees and courses designed to meet and cover the current demands of society.
- UGR also teach official postgraduate programmes controlled by demanding educational quality control systems.
- UGR teach 75 degrees in the 28 teaching centres
- The teaching is organized through 116 departments. The postgraduate School offers 68 Masters, 116 doctorates and 113 complementary courses.
- The UGR take in more than 60,000 undergraduate and postgraduate students study and another 20,000 attend complementary courses, language courses, summer courses, etc. They also have around 3,650 teachers and more than 2,000 administrative, technical and service personnel.



ICT Research Center (CITIC)

Higher School of Informatics and Telecommunication Engineering

Dept. of Signal Theory, Telematics and Communications

Smart Wireless Applications and Technologies Group

→ Permanent staff: 4 associate professors + several PhD/ MSc Students.

Design of devices

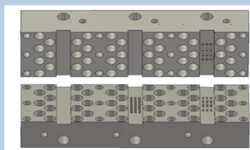
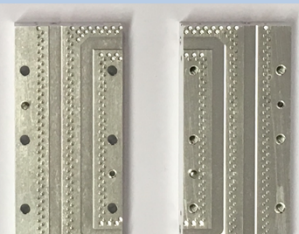
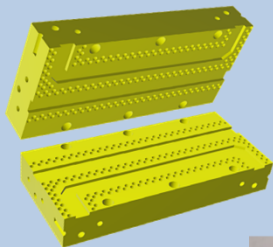
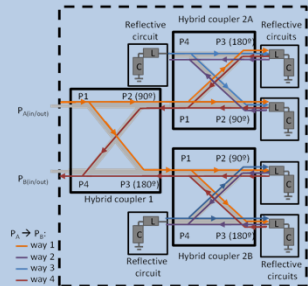

Top layer



Bottom layer

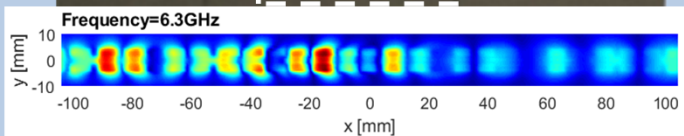

Design of Antenna

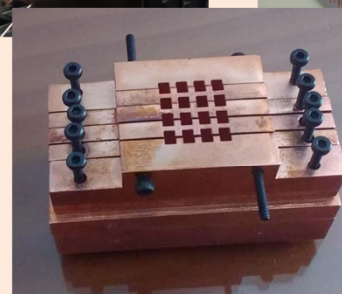
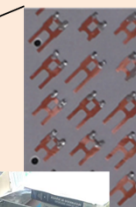
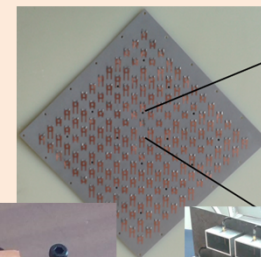
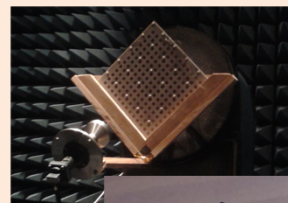
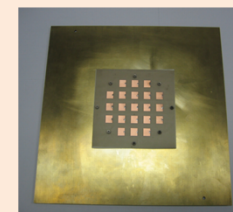
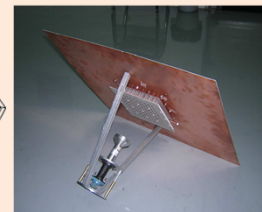
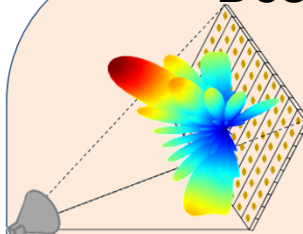

Measurement system for Antenna up to 300 GHz.

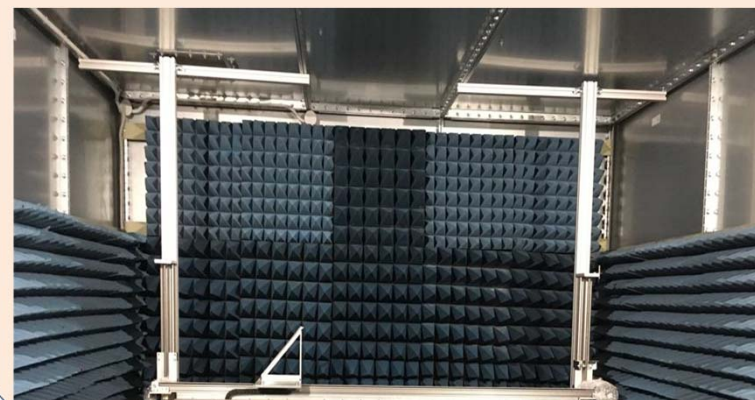

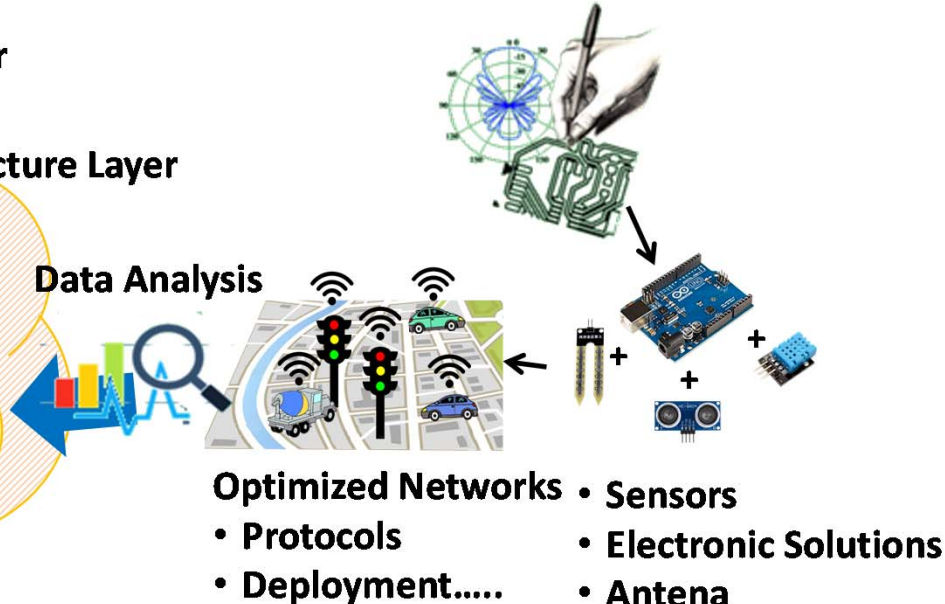
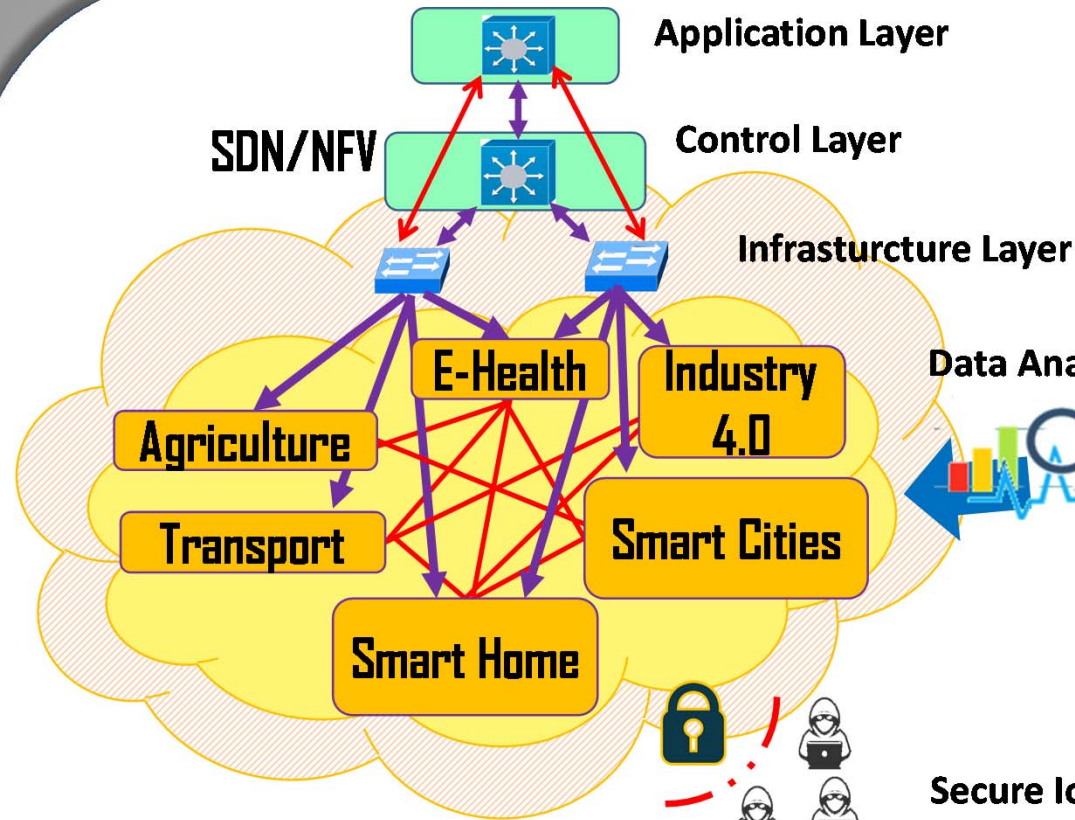

Smart applications of neurometry

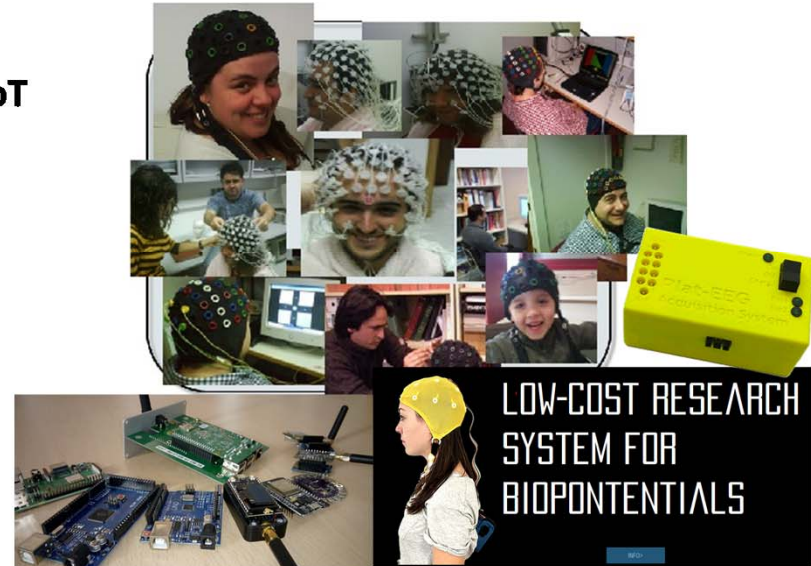

Indexed Journal (+105)

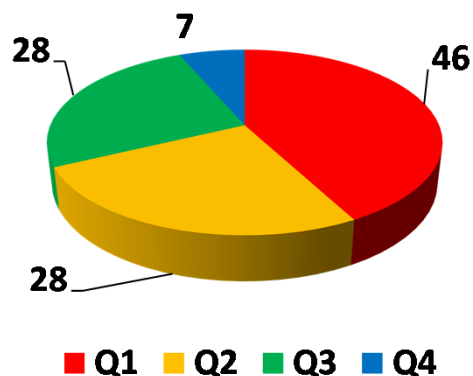
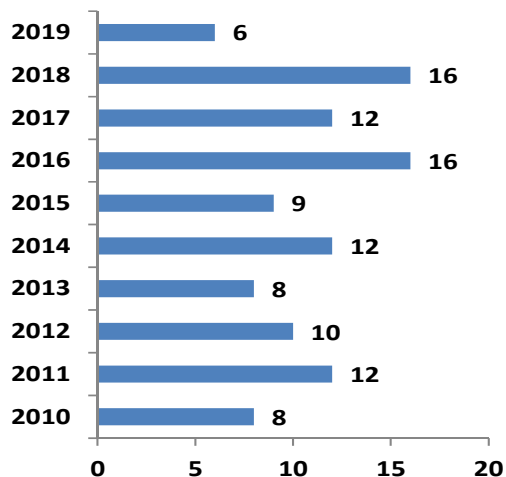

Book and Chapters (10)

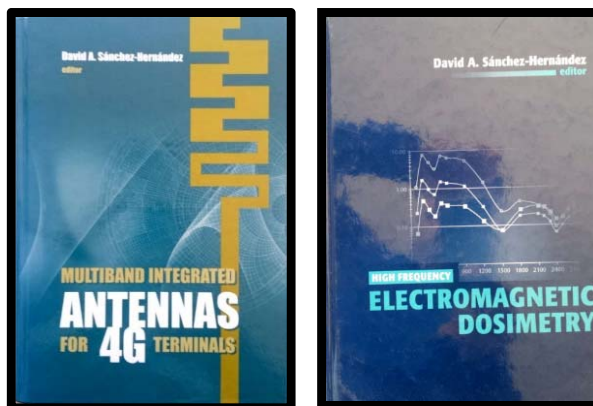

National and International Conferences (+120)

Patents (9)

US 20110155725A1

(19) United States
 (12) Patent Application Publication (10) Pub. No.: US 2011/0155725 A1
 Valenzuela Valdes et al. (43) Pub. Date: Jun. 30, 2011

PROJECTS

≈ 4 M€

Standardization Committees

3GPP TSG RAN WG4 Adhoc#2
 Dublin, Ireland, 12th – 16th April 2010

R4-101436

Source: iCTIA Certification Program Working Group
 Title: Standardized fading channel emulation for MIMO OTA using a mode-stirred chamber with sample selection method

Agenda Item	Contribution Number	Contribution
Document	RCSG100302	EMITE Ing
	Contribution Date	17.03.2010
	Contribution Topic	Standardized fading channel emulation for MIMO OTA using a mode-stirred chamber with sample selection method

Wireless Sensor Networks (WSNs)

- A wireless network sensors can be defined as a set of small, autonomous, easy-to-deploy devices called nodes.
- The nodes are formed by a sensor unit, a microcontroller, a transceiver (transmission / reception of messages) and internal batteries powered by solar panel.
- Each node has the capacity to wirelessly intercommunicate with the rest of the nodes, sending the captured information to a central point (gateway), from which and through the web the information is stored in a server so that it can be analyzed and consulted in the real time in the control center.

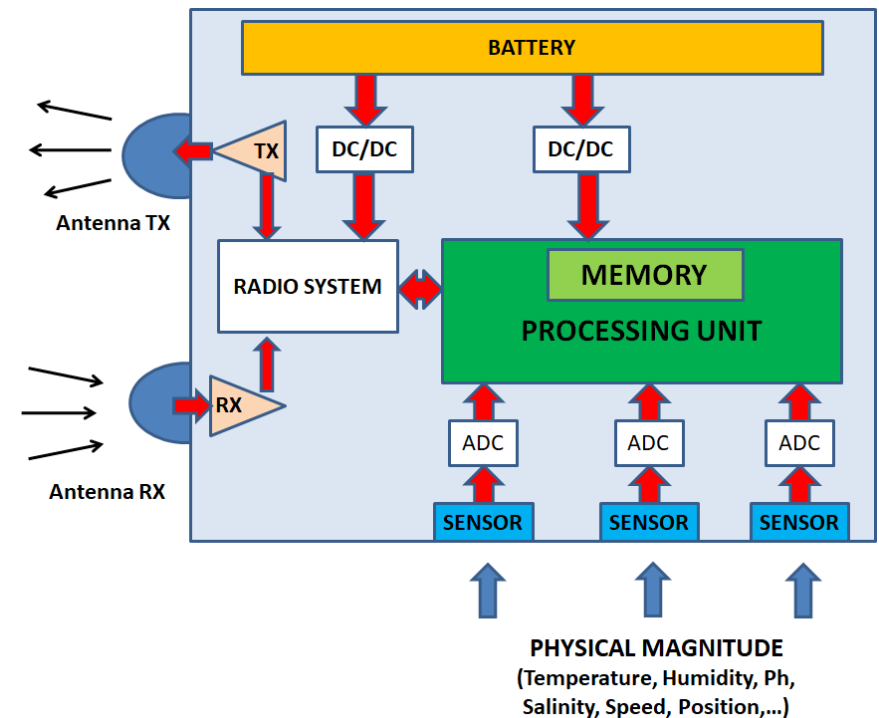

- The field of application of technology is very diverse, from agriculture, livestock, industrial processes, home automation, environment, logistics, security, accessibility, Smart Metering, Smart Home or Smart City, among some of the most prominent sectors.
- The advantages of this technology are:
 - Ease and speed of installation and deployment
 - Low consumption
 - Scalability
 - Devices with own autonomy and without cables
 - Reduced maintenance
 - Remote monitoring in real time, which reports to the client optimization of resources and processes
 - Versatility to adapt the system to the client's needs
 - Ability to couple several sensors in a single communication node
 - High capacity of self-organization and self-configuration with the rest of the nodal devices of the network, which allows the mobility of the devices.

- The evolution of technologies and the ability to interconnect different devices have led to the existence of networks capable of communicating and acting together, creating what is known as Internet of Things (IoT).
- Thanks to sensors and actuators, it is possible to measure our environment and share data which, collected by platforms, allows the developers to create useful applications for the society.

The new concept of WSNs for IoT - LoRa for IoT -

LoRaWAN Introduction

LoRa ≠ LoRaWAN

- The first thing that needs to be clarified is that LoRa and LoRaWAN are not the same, LoRa is the type of radiofrequency modulation patented by Semtech. Its main advantages are:
 - High tolerance to interference
 - High sensitivity to receive data (-168dB)
 - Based on chirp modulation
 - Low power Consumption (up to 10 years with a battery *)
 - Long range: 10 to 20km
 - Low data transfer (up to 255 bytes)
 - Point to point connection
 - Working frequencies: 915Mhz America, 868 Europe, 433 Asia
- It is the ideal technology for connections over long distances and for IoT networks that can be used in smart cities, places with little cellular coverage or private networks of sensors or actuators, that's why LoRaWAN was born.

LoRaWAN Introduction

- LoRaWAN is an open and standardized LPWAN, which uses long range (LoRa) or frequency shift keying (FSK) in the physical layer.
- LoRa modulation was developed by Cycleo, later acquired by Semtech.
- According to Semtech, the key features of this technology are:
 - Low cost (in terms of infrastructure investment, operating expenses, and end devices), standardization (allowing interoperability),
 - Low power (extending battery lifetime up to 20 years),
 - Long range (deep penetration in dense urban/indoor regions, and up to 30 miles in rural areas),
 - Geolocation (GPS-free geolocation without requiring additional power),
 - Security (end-to-end AES Advanced Encryption Standard, AES, encryption) and,
 - High capacity (support of many devices per LoRaWAN gateway).

LoRaWAN Introduction

- Unlike other IoT technologies, LoRaWAN does not use a mesh network architecture.
- Although mesh networking may be useful to increase the communication range, it also affects the device battery life due to the forwarding of messages. → LoRaWAN uses a star topology
- LoRaWAN allows end devices to have bidirectional communications, although they are asymmetric, since uplink transmissions (from end devices to gateways) are strongly favored.

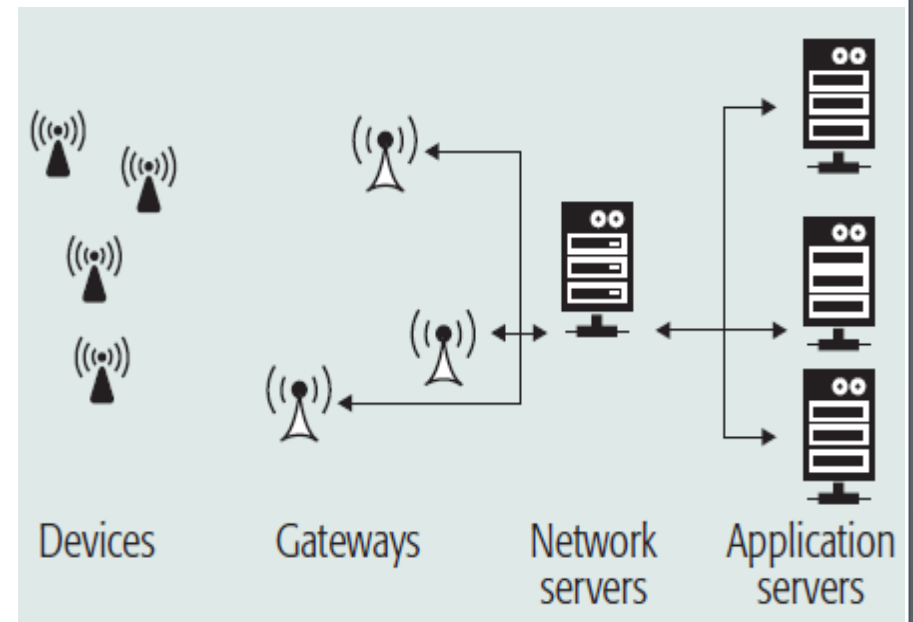

LoRaWAN Introduction

- Three types of devices defined in the standard, each with different capabilities:
 - **Class A devices** are typically battery powered sensors. This class is the most energy-efficient and must be supported by all devices, but the network can only transmit to the device after a data transmission from the device has finished. For this, the device has to check for downlink transmissions during two receive windows.
 - **Class B devices** are disabled after a successful transmission in the first window. This class is intended for energy-limited devices. Class B allows devices to increase their downlink traffic and to reduce the latency for downlink communications (e.g. battery powered actuators). The gateway sends periodic beacons to synchronize these devices in order to schedule further receive windows (*ping slots*). The reception of downlink traffic increases the power requirement for these devices.
 - **Devices implementing Class C** communications profiles are used for applications that have enough power available and can receive at any moment except during transmissions.

LoRaWAN Introduction

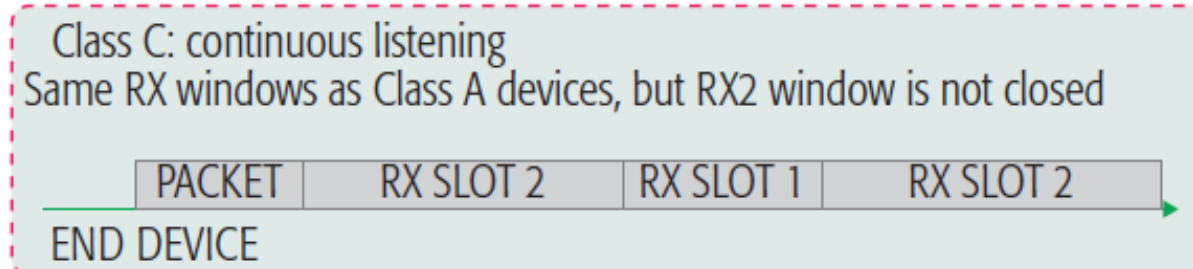
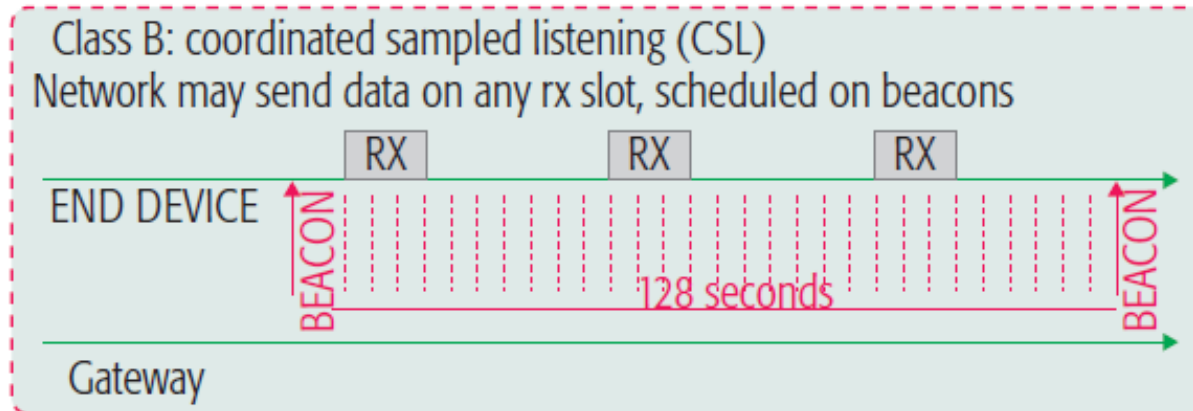
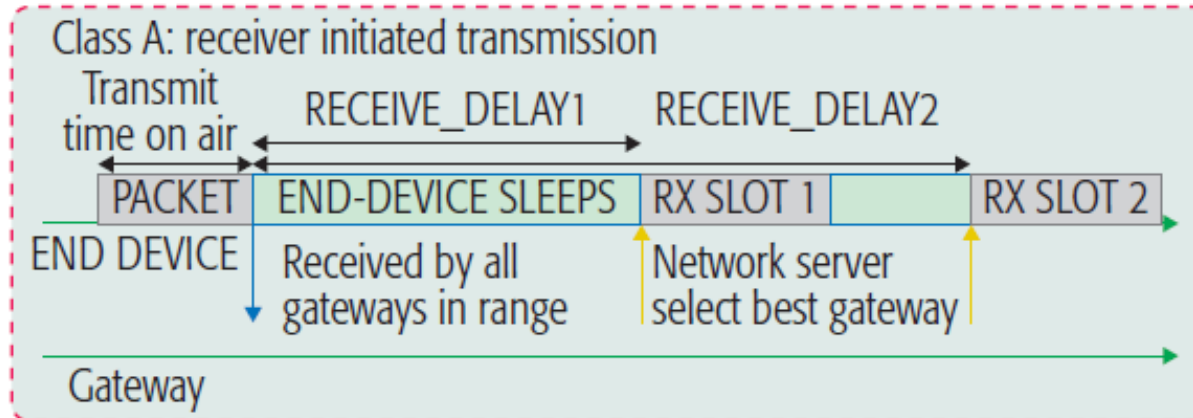

LoRaWAN Introduction

- The underlying PHY layer for the three classes is the same.
- LoRa is a proprietary spread spectrum modulation scheme which is based on chirp spread spectrum (CSS).
- Some of the key properties of this modulation are scalable bandwidth, constant envelope, low power, high robustness, multipath and fading resistant, Doppler resistant, long-range capability, enhanced network capacity, and geolocation capabilities.
- Using different spreading factors (SFs), the developer may trade data rate for coverage or energy consumption. The spreading factor is defined as

$$SF = \log_2 \left(\frac{R_C}{R_S} \right)$$

R_S and R_C are the
symbol and chip rates

LoRaWAN Introduction

- The usage of a high SF decreases the data rate but increases the maximum distance between the transmitter and the receiver, and vice versa.
- Since transmissions using different SFs are orthogonal, it is possible to receive multiple frames simultaneously.
- LoRa error correction reduces the bit rate by a factor rate code = $4 / (4 + CR)$, where code rate (CR) is an integer value between 1 and 4.

$$Rb = SF \times \frac{4}{\frac{4 + CR}{2^{SF}} \cdot BW}$$

- Since SFs vary from 7 to 12, and frames sent with different SFs can be decoded simultaneously, the maximum aggregated bit rate (assuming $BW = 500$ kHz and $CR = 1$) is 43 kb/s.

LoRaWAN Introduction

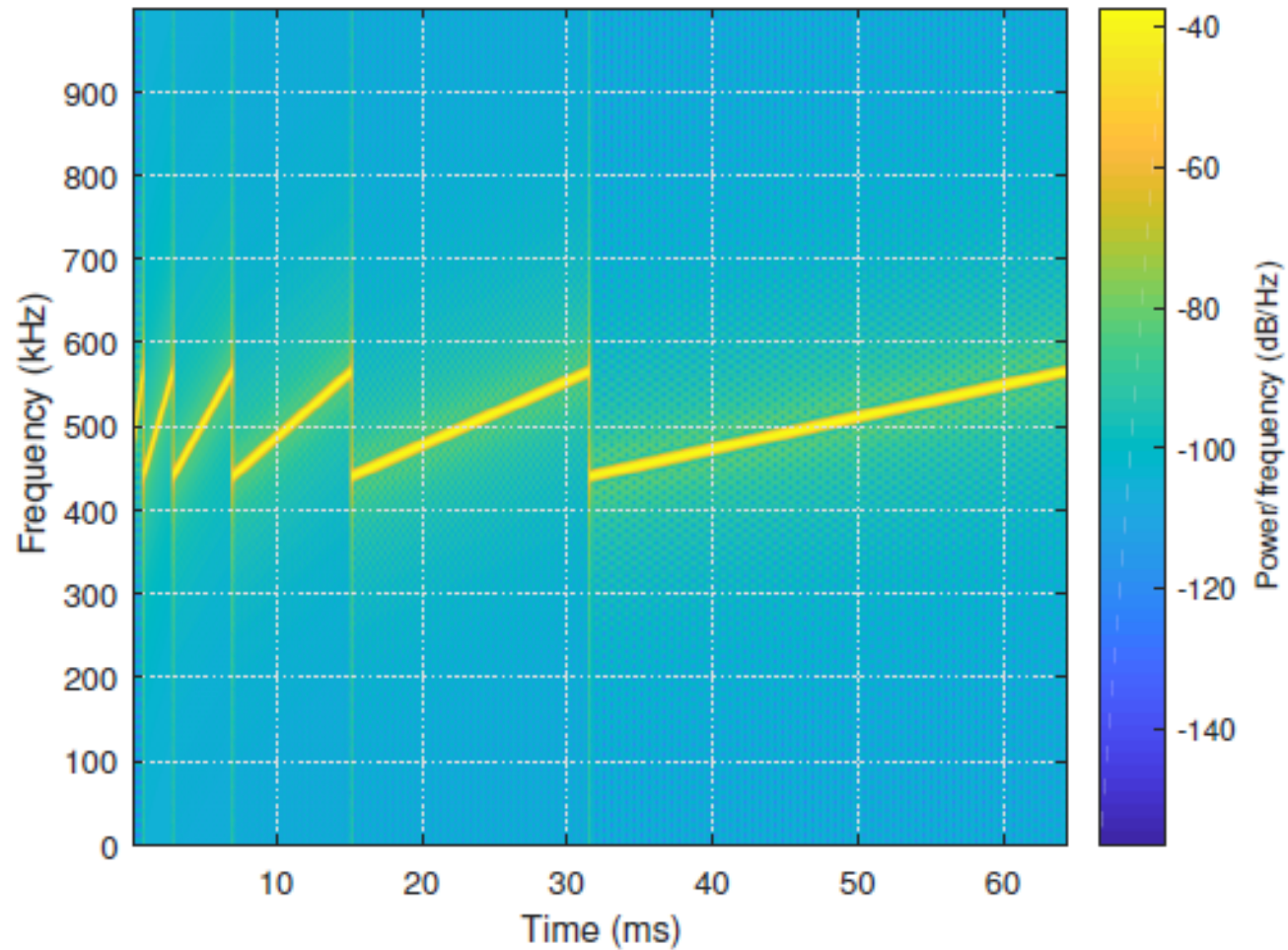

It shows how frequency, time and power vary according to the SF used.

LoRaWAN Security

- As security is crucial, it has been included from the initial versions of the standard.
- Security for LoRaWAN is also designed for low power consumption, low implementation complexity, low cost, and high scalability.
- The main properties of LoRaWAN security are mutual authentication, integrity protection, and confidentiality.
- An end device can be activated using either *over-the-air activation* (OTAA) or *activation by personalization* (ABP). The device stores the following information:
 - DevAddr* (device address), *AppEUI* (application identifier),
 - NwkSKey* (network session key), and *AppSKey* (application session key).

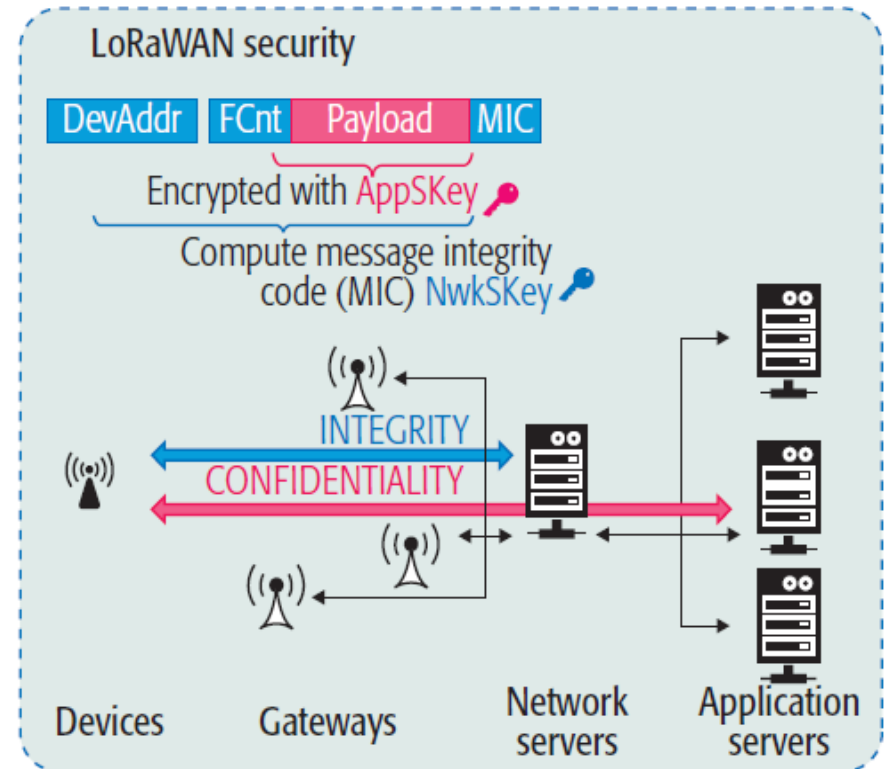

LoRaWAN Security

- An end device can be activated using either *over-the-air activation* (OTAA) or *activation by personalization* (ABP). The device stores the following information:
 - DevAddr* (device address), *AppEUI* (application identifier),
 - NwkSKey* (network session key), and *AppSKey* (application session key).

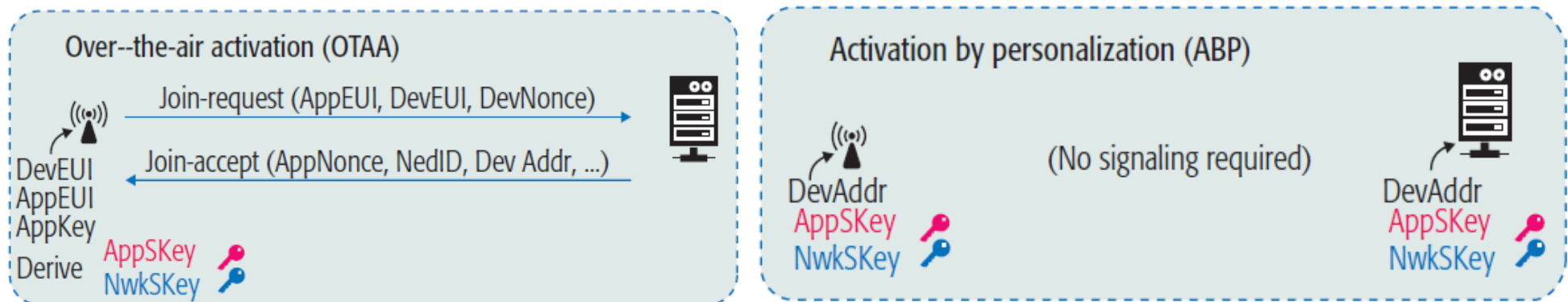

LoRaWAN Security

- For ABP:
 - The device has to be previously customized with these parameters.
- For OTAA,
 - The device derives the session keys during the join procedure using the following information: DevEUI (a unique device identifier), AppEUI (an application identifier), and AppKey (an AES-128 key).
 - When the activation is OTAA, both the join request and accept messages include a message integrity code (MIC) computed using the Cipher-Based Message Authentication Code (AES-CMAC) algorithm with the AppKey.
 - It allows each end to verify that the other end knows this key, thus achieving mutual authentication.
 - The MIC field is used by both the device and the network server to verify data integrity.

Comparison

Parameter	Comparison	
	WiFi	LoRa
Frequency Band	2.4 GHz	868 (EU) – 433 (US) [MHz]
Spectrum	Unlicensed	Unlicensed
Data Rate	100 – 300 [Mbps]	125 – 500 [kHz]
Range	30 – 100 [m]	Up to hundreds of kms

- **LoRa** is a proprietary spread spectrum modulation which belongs to Semtech.
- It keeps the same low power characteristics of FSK modulation while increases the communication range.
- According to the frequency band (868 MHz in Europe), it modulates its symbols with a bandwidth of 125 kHz, 250 kHz or 500 kHz (European case) with different Spreading Factors (SF). A lower SF lets increases the maximum distance between transmitter and receiver by decreasing the data rate.
- The use of LoRa modulation with a low spreading factor could facilitate the transfer of small data packets at indoor environments like hospitals.

CHARACTERISTICS OF LPWAN TECHNOLOGIES

Parameter	Standard			
	LoRa	Sigfox	RPMA	nWave
Frequency Band	868/915 MHz ISM	868/902 MHz ISM	2.4 GHz ISM	Sub-GHz ISM
Bandwidth	Ultra NB	8x125kHz Mod: CSS	1 MHz 40 channels	Ultra NB
Range	2-5k urban 15k rural	30-50k r. 1000k LoS	500k LoS	10k u. 20-30k r.

Hardware for IoT



WiFi-based Hardware for IoT

Customized Modules

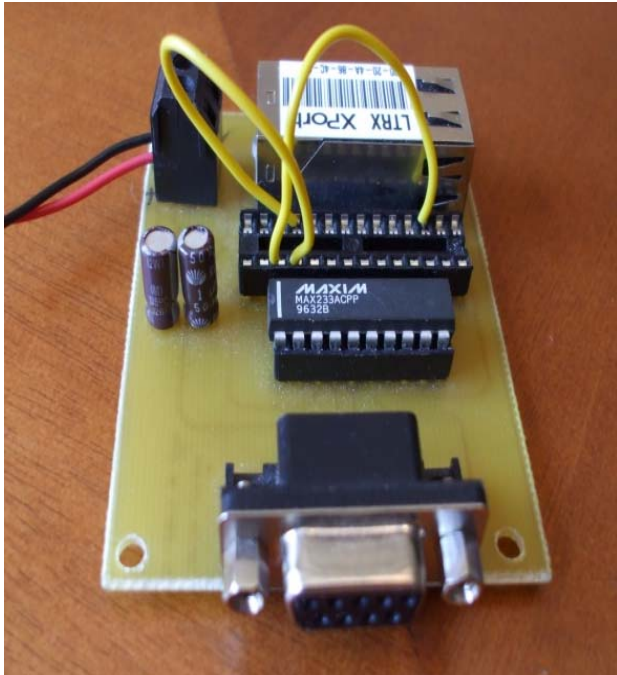

XPort and Matchport, from Lantronix

Flyport

http://wiki.openpicus.com/index.php/Main_Page



Flyport Lite

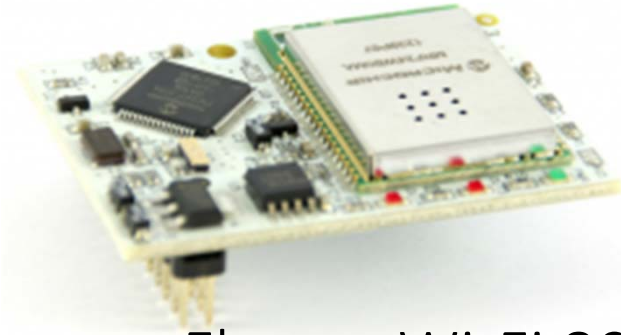

Flyport Wi-Fi 802.11g



Flyport Ethernet



Flyport GPRS

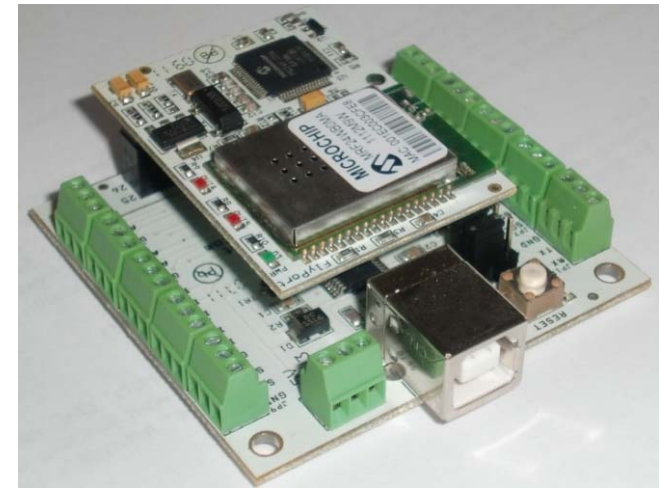
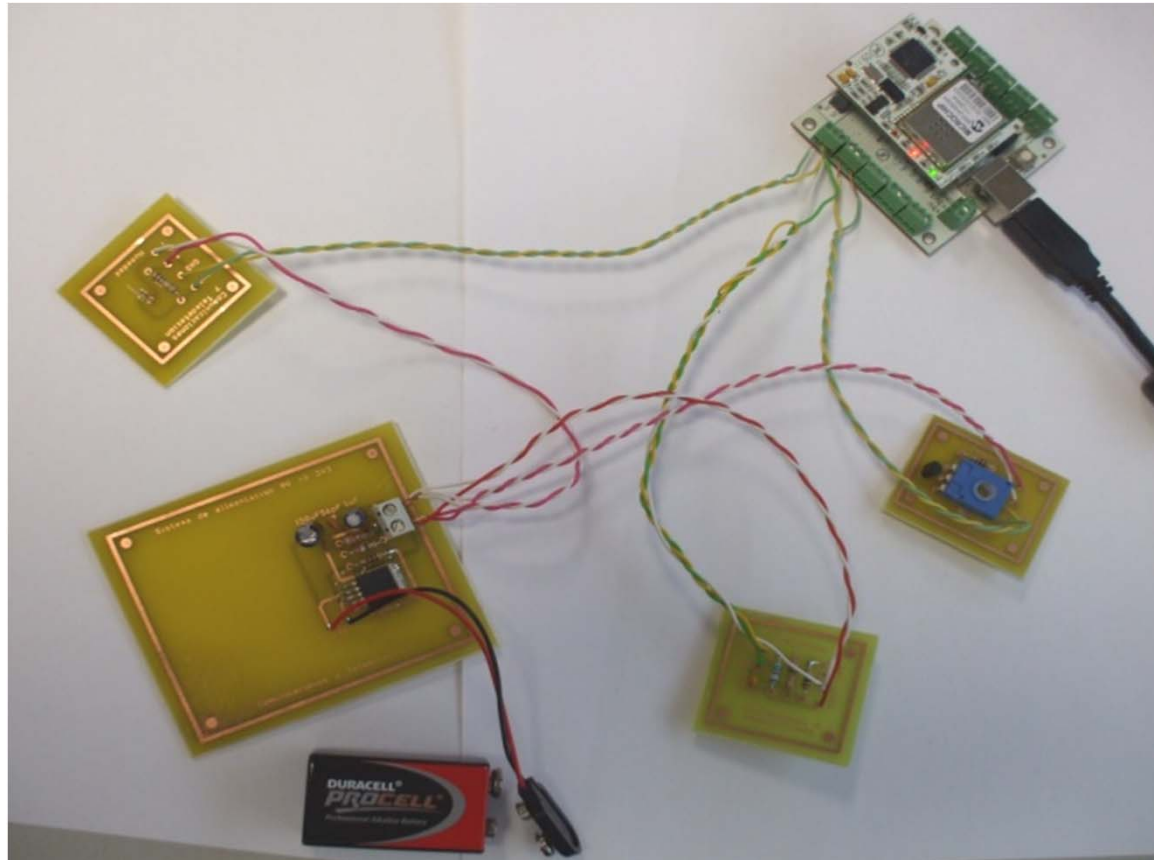

Flyport (openPICUS)

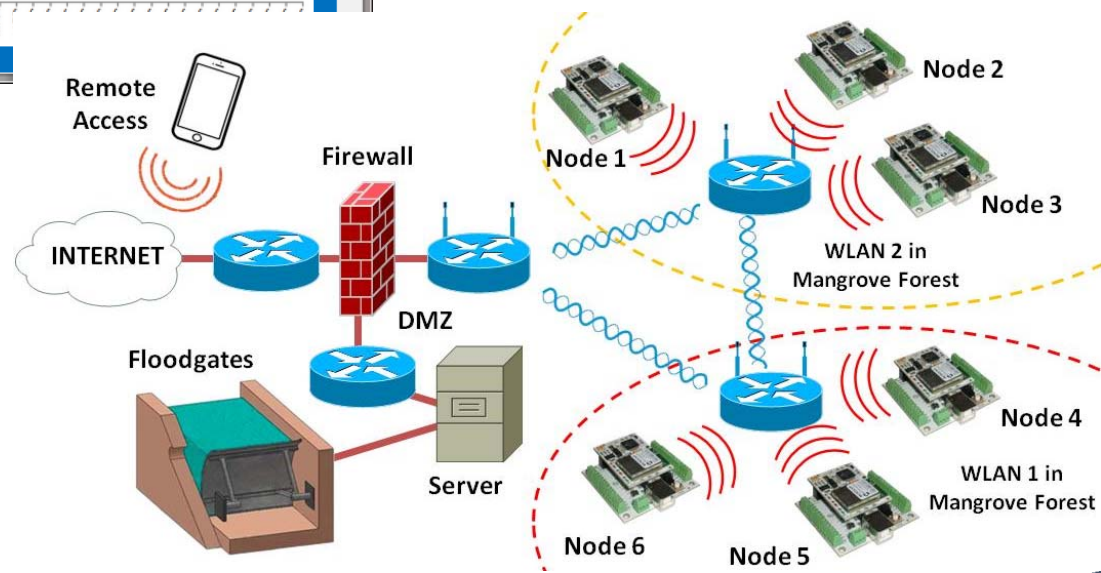
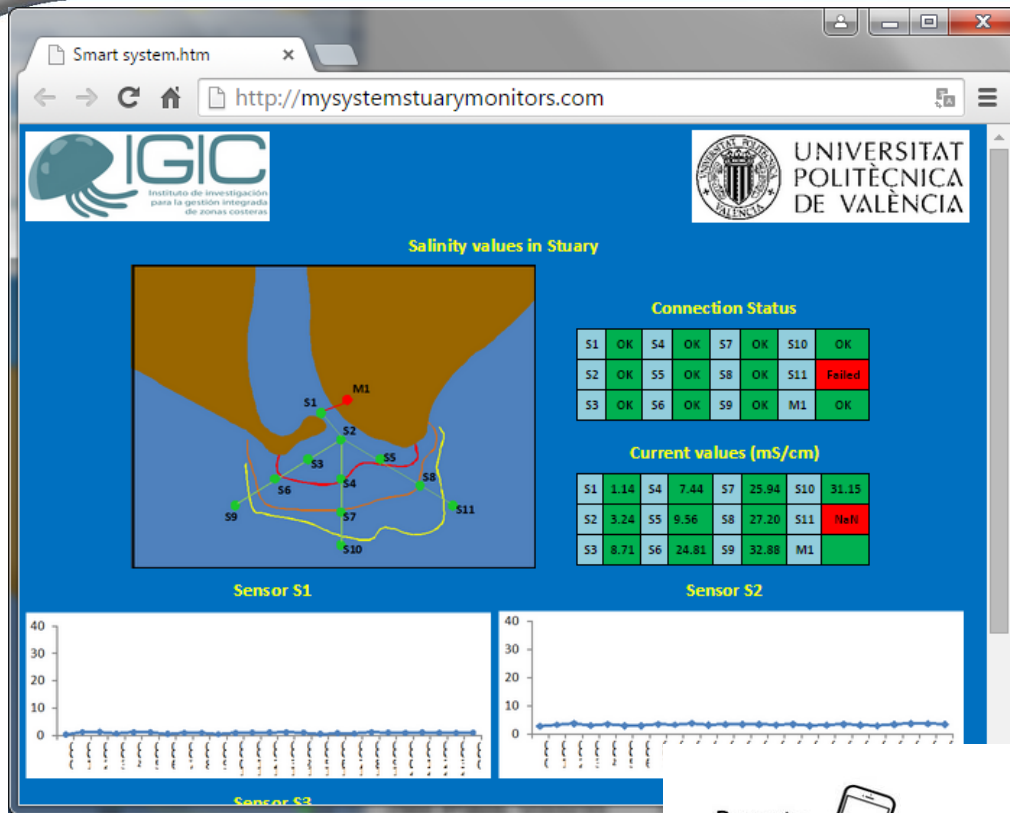



Wasp mote (Libelium)

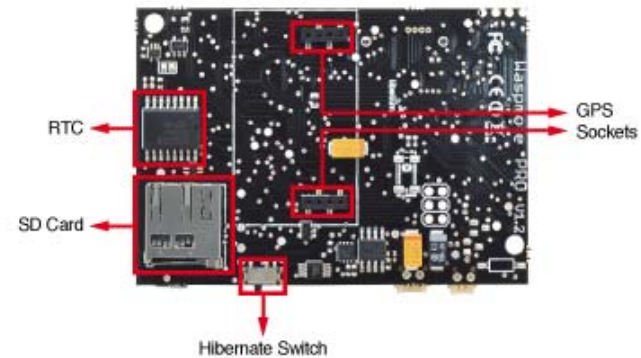
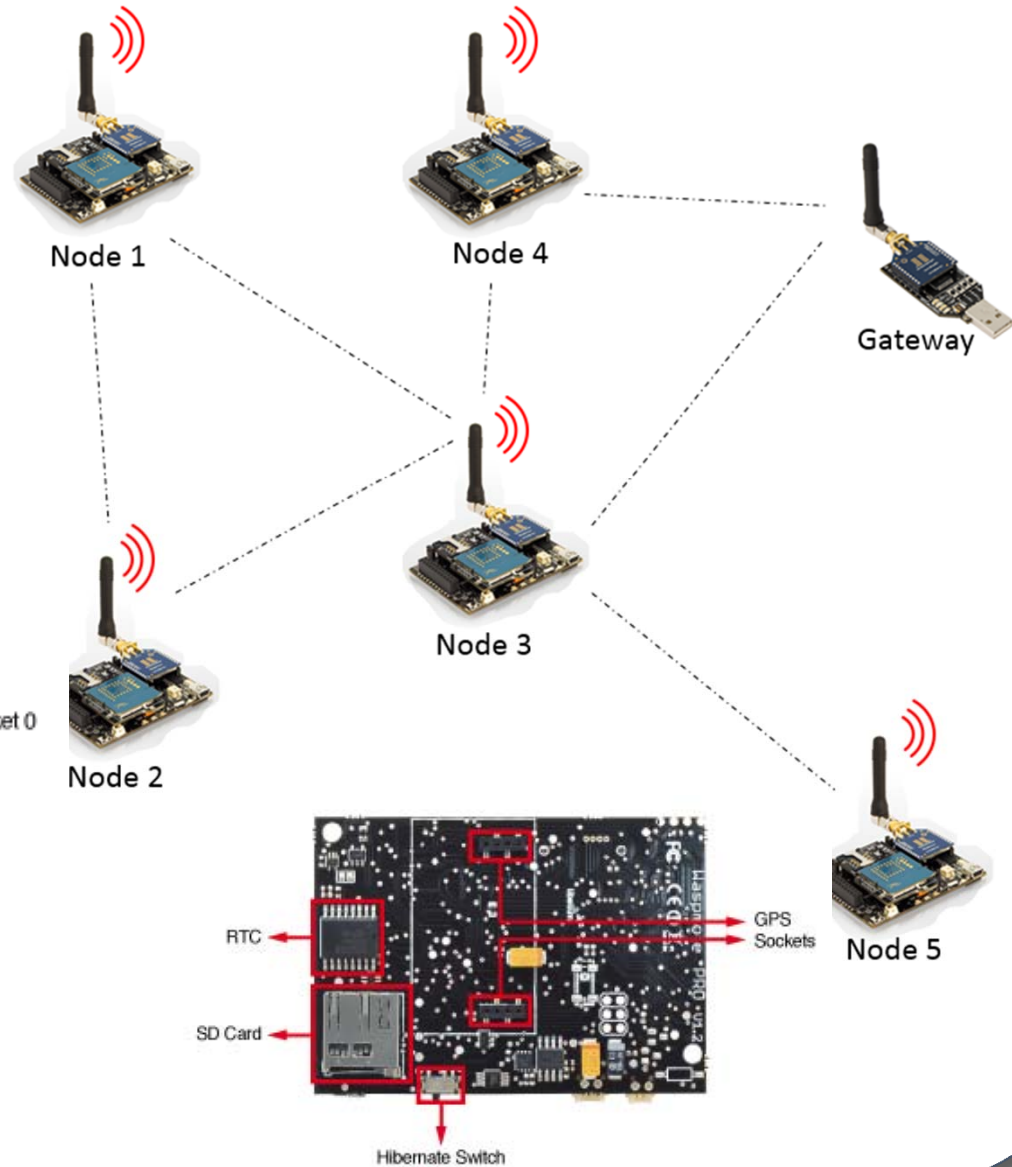
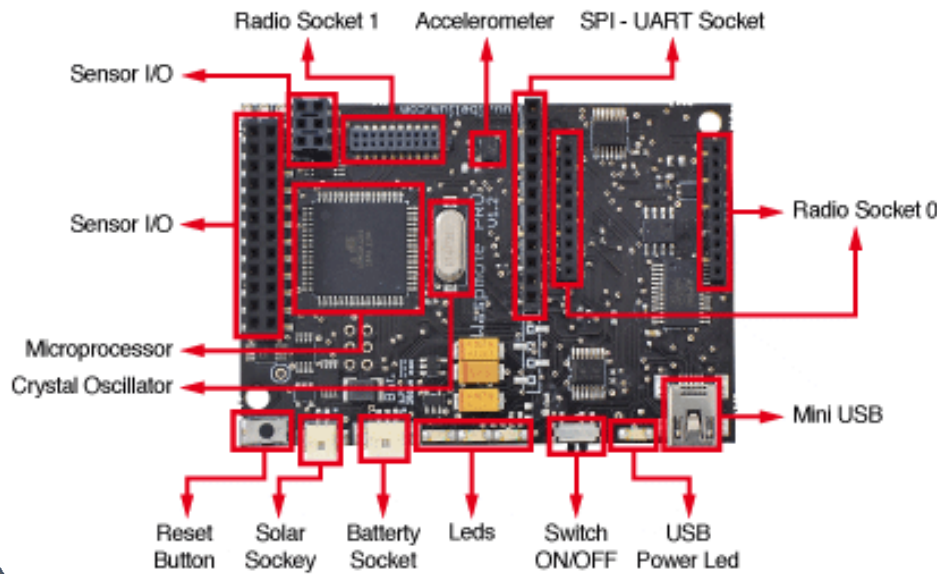



Arduino UNO

ENTRY LEVEL	UNO LEONARDO 101 ESPLORA MICRO NANO MINI MKR2UNO ADAPTER
	STARTER KIT LCD SCREEN
ENHANCED FEATURES	MEGA ZERO DUE MEGA ADK MO MO PRO MKR ZERO MOTOR SHIELD
	USB HOST SHIELD PROTO SHIELD MKR PROTO SHIELD 4 RELAYS SHIELD
	MEGA PROTO SHIELD MKR RELAY PROTO SHIELD ISP USB2SERIAL MICRO
	USB2SERIAL CONVERTER
INTERNET OF THINGS	YŪN ETHERNET TIAN INDUSTRIAL 101 LEONARDO ETH MKR FOX 1200
	MKR WAN 1300 MKR GSM 1400 MKR1000 YUN MINI YŪN SHIELD WIRELESS SD SHIELD
	WIRELESS PROTO SHIELD ETHERNET SHIELD V2 GSM SHIELD V2 MKR IoT BUNDLE



Arduino Mega

Microcontroller	ATmega2560
Operating Voltage	5V
Input Voltage (recommended)	7-12V
Input Voltage (limit)	6-20V
Digital I/O Pins	54 (of which 15 provide PWM output)
Analog Input Pins	16
DC Current per I/O Pin	20 mA
DC Current for 3.3V Pin	50 mA
Flash Memory	256 KB of which 8 KB used by bootloader
SRAM	8 KB
EEPROM	4 KB
Clock Speed	16 MHz
LED_BUILTIN	13
Length	101.52 mm
Width	53.3 mm
Weight	37 g

8266- ESP01

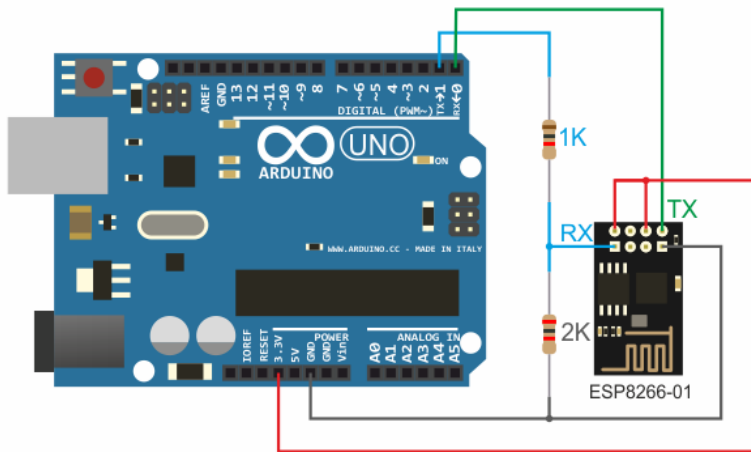
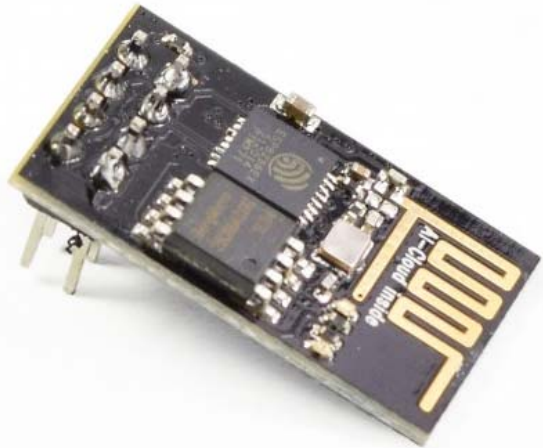

- 802.11 b/g/ n
- WIFI @ 2.4 GHz, soporta WPA / WPA2
- Size 11.5mm * 11.5mm
- ADC 10 bit
- Protocol stack TCP/IP integrated
- Output Power: 802.11b mode + 19.5dBm
- CPU of 32 bits and low power.
- SDIO 2.0, SPI, UART
- STBC, 1×1 MIMO, 2×1 MIMO
- Turning on and transferring packages <2ms.
- Power consumption in iddle mode: 1.0mW
- Operation range: -40 ~ 125 °C

WEMS LOLIN32 V1.0.0 ESP-32 Rev1 wifi y bluetooth con Flash de 4 MB

WIFI

Bluetooth

4 MB Flash

Battery: Lithium 500mA Max

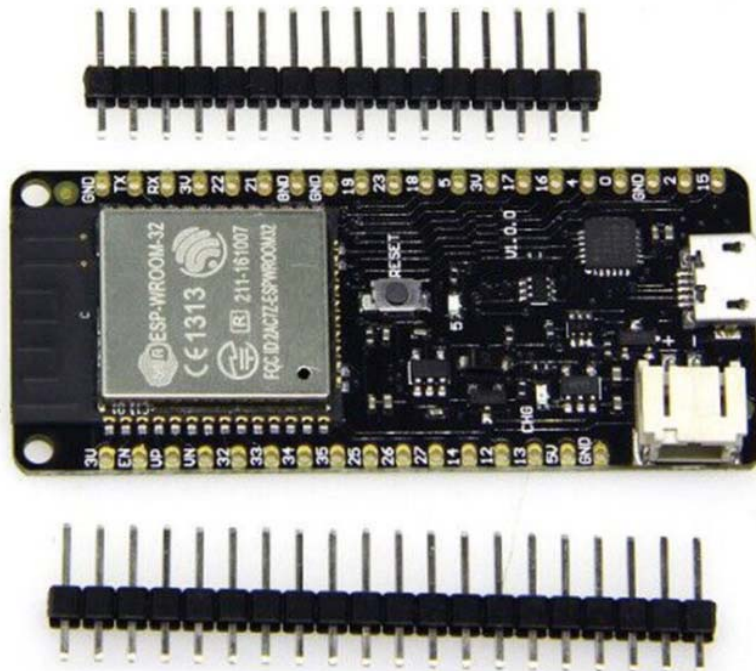

Microcontroller	ESP-32
Board Power Supply (USB/VIN)	5V
Supported Batteries	Lipo Battery 3.7V
Operating Voltage	3.3V
Digital I/O Pins	22
Analog Input Pins	6 (VP, VN, 32, 33, 34, 35)
Analog Output Pins	2 (25, 26)
LED_BUILTIN	5
Clock Speed(Max)	240Mhz
Flash	4M bytes
PSRAM	4M bytes
Length	6.5mm
Width	2.54mm
Weight	7.5g

ESP32 WiFi + Bluetooth Ultra-Low power consumption

Dual Core ESP-32S ESP32 ESP8266

<http://espressif.com/en/products/hardware/esp32-devkitc/overview>

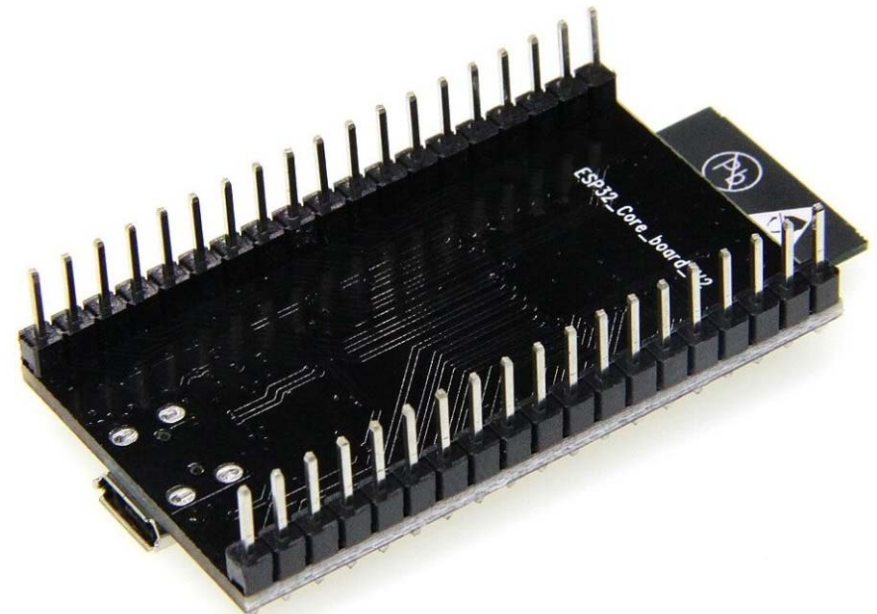
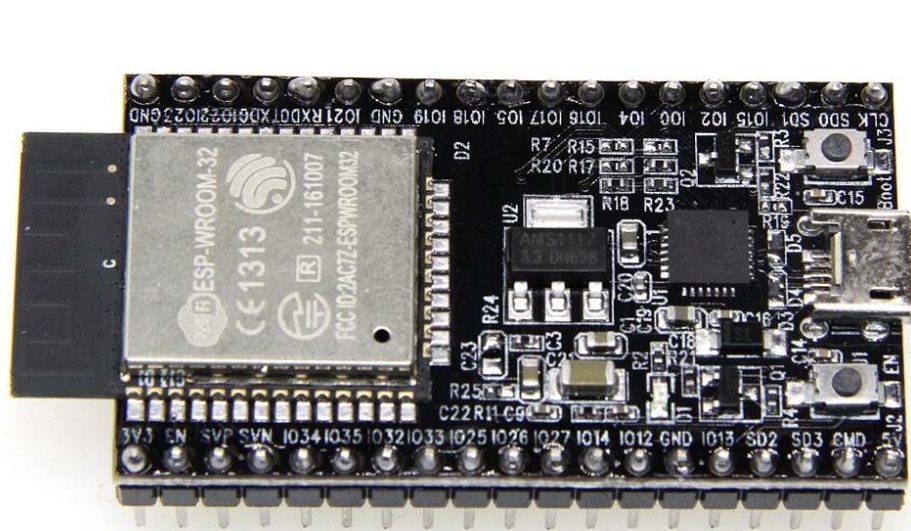

D1 mini-Mini NodeMcu 4Mbytes ESP8266 Lua WIFI

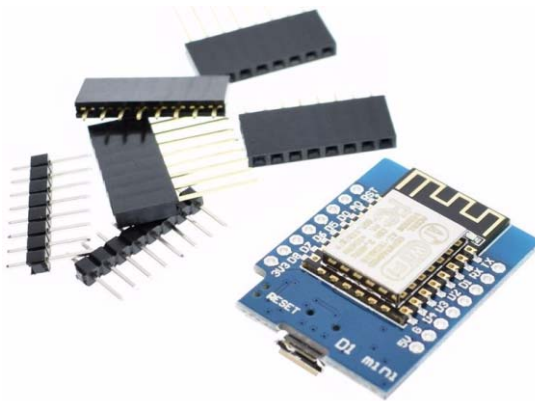

WeMos System

11 digital inputs/outputs

1 in analogic Input (3.3 V max)

Micro USB connection

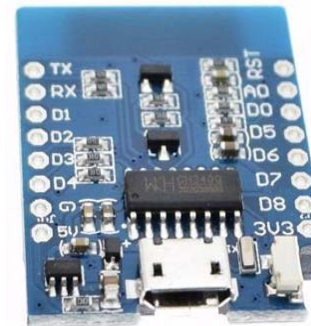
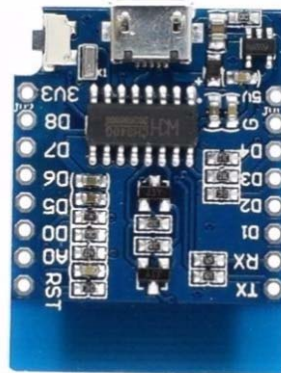
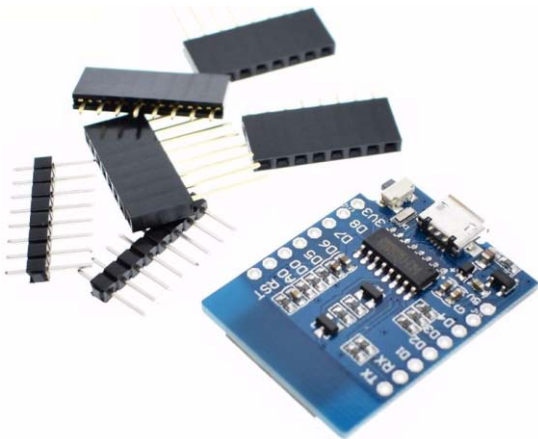

LoRa-based Hardware for IoT

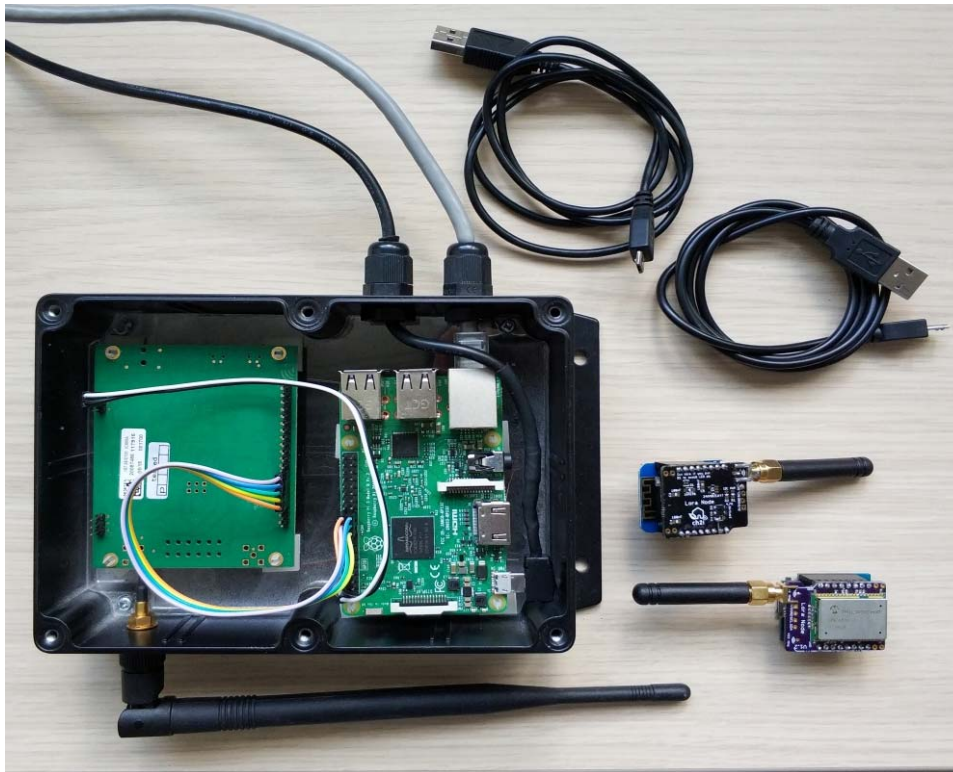

DIY multi-channel Raspberry Pi Gateway:

- Raspberry Pi 3 Model B,
- IMST ic880A concentrator with a maximum transmission power of 20 dBm
- an 868 MHz antenna with 2 dBi gain.

LoRa Lite by IMST



The LoRa Lite Gateway from German company IMST is a reasonably-priced eight-channel gateway based on their iC880A 868 MHz LoRaWAN concentrator and a Raspberry Pi, all fitted on a motherboard in a die-cast box:

Base on SX1301 LoRaWan Gateway Module

- Frequency band 433MHz/868MHz/915MHZ
- Sensitivity: down to -138dBm, Output Power up to 20dbm
- open 8 channels uplink and 1 channel downlink for Makers
- SX1301 based processor
- USB or SPI interface



The Things Indoor Gateway



The following are the specs:

- Supports TTN and SLA
- Designed for indoor usage (prototyping)
- Features a setup and reset button
- USB-C port (for power only)
- Supports 868 or 915 frequency bands
- 8 channel, design v1.5 (with LBT)
- Integrated antenna
- ESP8266 SoC, allowing WiFi connectivity
- Able to be plugged directly into a wall outlet

TTGO LORA32 V2.0/433/868/915 MHz ESP32

- Chip Wifi ESP32 @ 80 MHz - 802.11 b/g/n
- 900 Mhz LoRa Module
- Compatible with Arduino
- OLED Screen 128x64 px
- MicroUSB (powering and programming)
- Antenna de 2dBi with SMA connector





RAK811 LoRa Tracker
Wireless Remote Positioning Solution



- TTGO T-Beam node. It is built around the ESP32 chip.
- It has 4MB of SPI flash.
- It operates at 433 MHz, 868 MHz and 915 MHz.
- TTGO T-Beam node includes two antennas. A GPS ceramic antenna connected to a u-bloc NEO-6M GPS module and another LoRa antenna with SMA connector.
- It uses a LoRa chip from the HopeRF RFM9X family. The node has a total of 26 pins with GPIO, ADC, VP/VN, DAC, Touch, SPI, I2C, UART and Lora.
- It can be feed by batteries.



Aplicaciones

- Smart Home
- Home Video
- Control Lights
- Snooze Button
- Take Pictures
- Wireless Trigger
- Remote Switch

IoT Applications

Mobile Low Cost system for Environmental Monitoring in Emergency Situations

Motivation

- Nowadays, the world is suffering from numerous wildfires. Year by year, thousands of hectares are destroyed.
- The consequences are terrible for the ecosystem and the economy of that area.
- Part of the people who died in those fires did so trying to escape from the fire by using rural roads. Detecting a fire on time and knowing the best escape routes to avoid it are of great importance in order to save the life of both citizens and fire fighters.
- There are many systems that are employed for ambient and environmental monitoring → Most of them are developed for cities or for measuring air pollution.
- There are many wildfire detection systems based on image processing which require the deployment of WSNs. → Too many nodes → Too expensive.
- Deploying fire detection systems in vehicles can help to avoid accidents where the occupants of a vehicle get trapped by fire by alerting the driver.

System description and proposed architecture

- In a forest fire near to residential areas, one of the main goals is to ensure the evacuation of people through a secure way.
- Parameters to be monitored and shared along the network:
 - GPS position and vehicle tracking.
 - Vehicle status, i.e., if it has suffered an accident or it is blocking an escape routes.
 - Presence of fire.
 - Presence of Carbon dioxide or a poor quality of air that difficult the breathing.
 - The system must be installed in a vehicle, without having to make any type of modification in its manufacture.

System description and proposed architecture

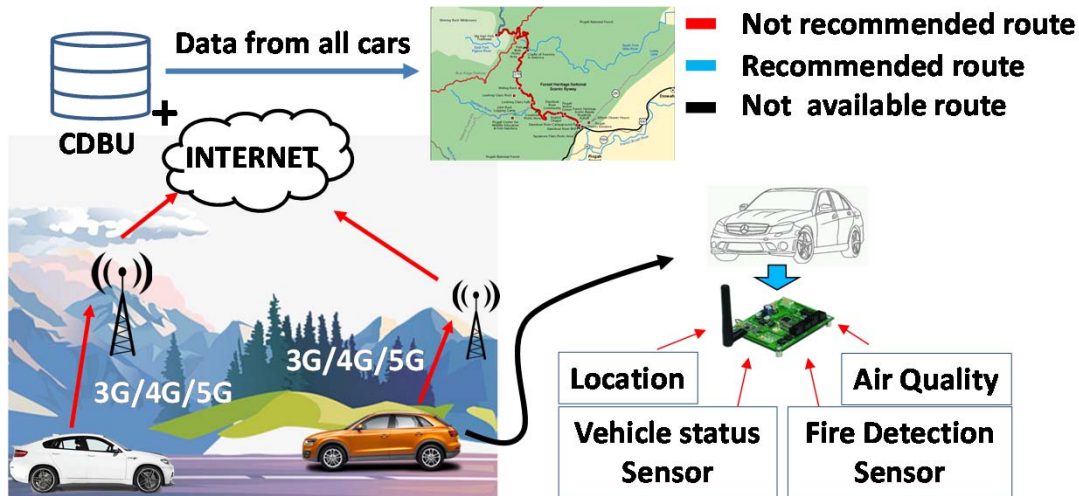

Proposed Architecture for the system.

Operation Algorithm

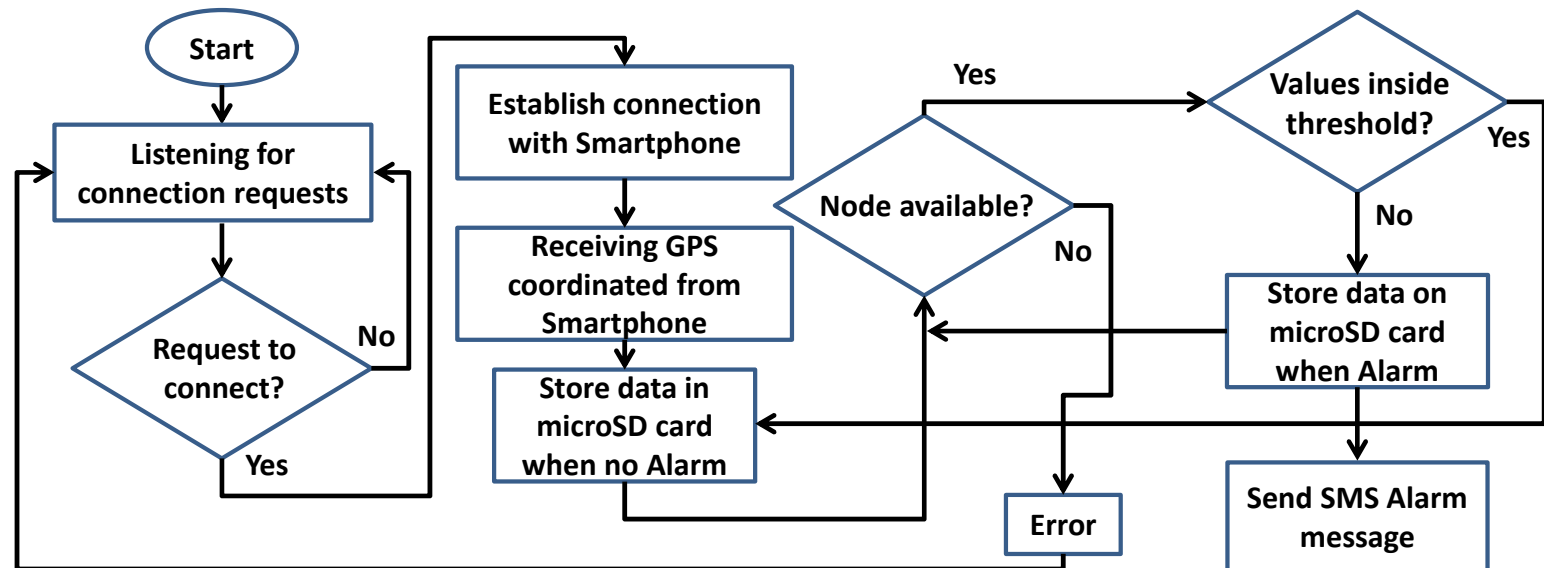

Design and implementation

- The system should be:
 - Cheap and easily installable in a vehicle.
 - Versatile and should be independent from the vehicle brand.
 - Able to take data on geographical position from the smartphone the driver has.
 - The data exchange between drivers' smartphone and the system should be through permanent Bluetooth connection.

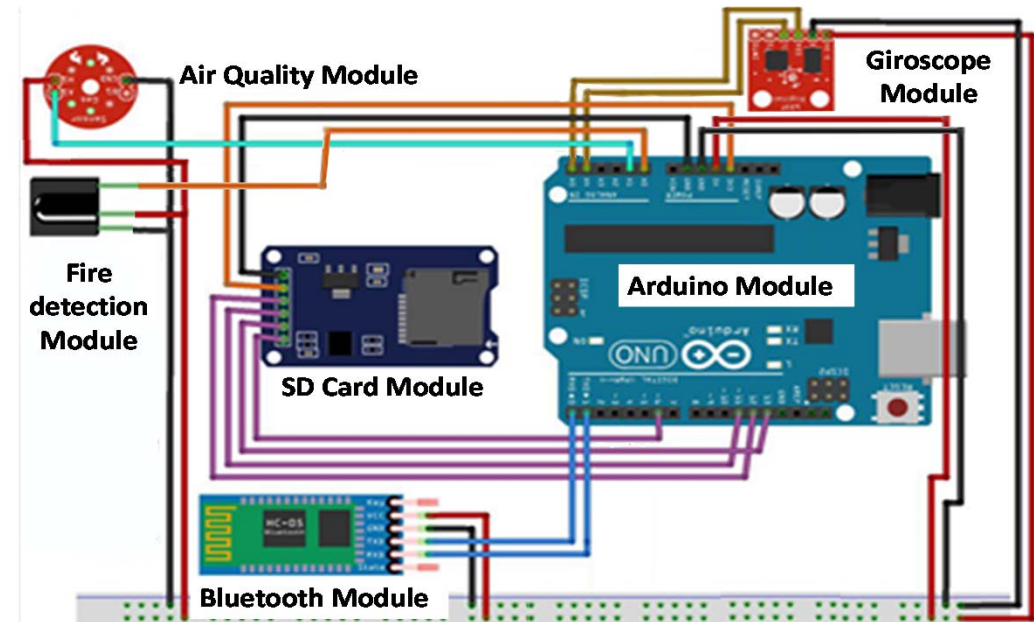
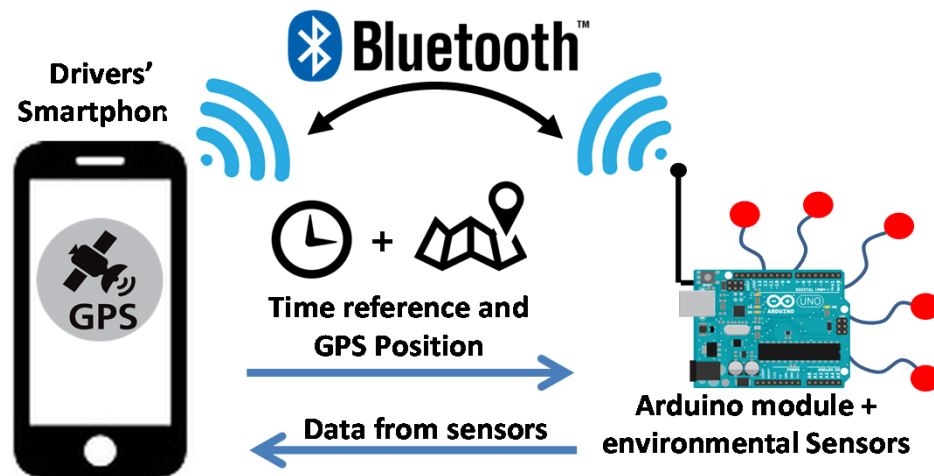

GPS position

- The first test is focused on determining the geographical position of our vehicle.
- Measurements are taken every 30 seconds.
- Data is sent to the Arduino module and stored as a file text in the microSD Card.

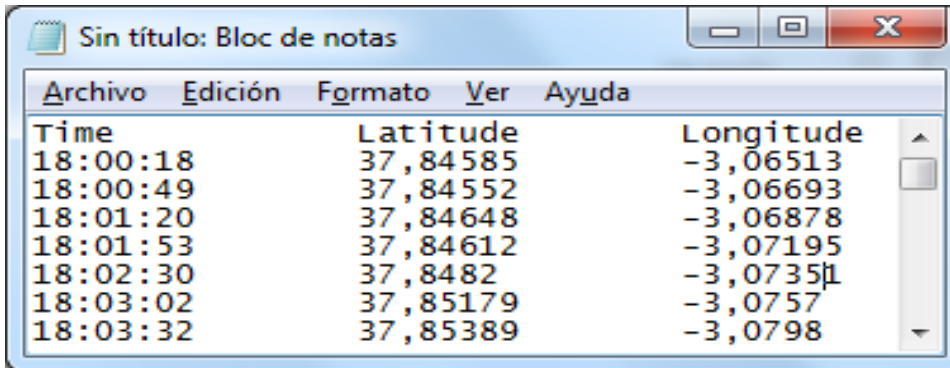

Time	Latitude	Longitude
18:00:18	37,84585	-3,06513
18:00:49	37,84552	-3,06693
18:01:20	37,84648	-3,06878
18:01:53	37,84612	-3,07195
18:02:30	37,8482	-3,07351
18:03:02	37,85179	-3,0757
18:03:32	37,85389	-3,0798

Text file with GPS coordinate

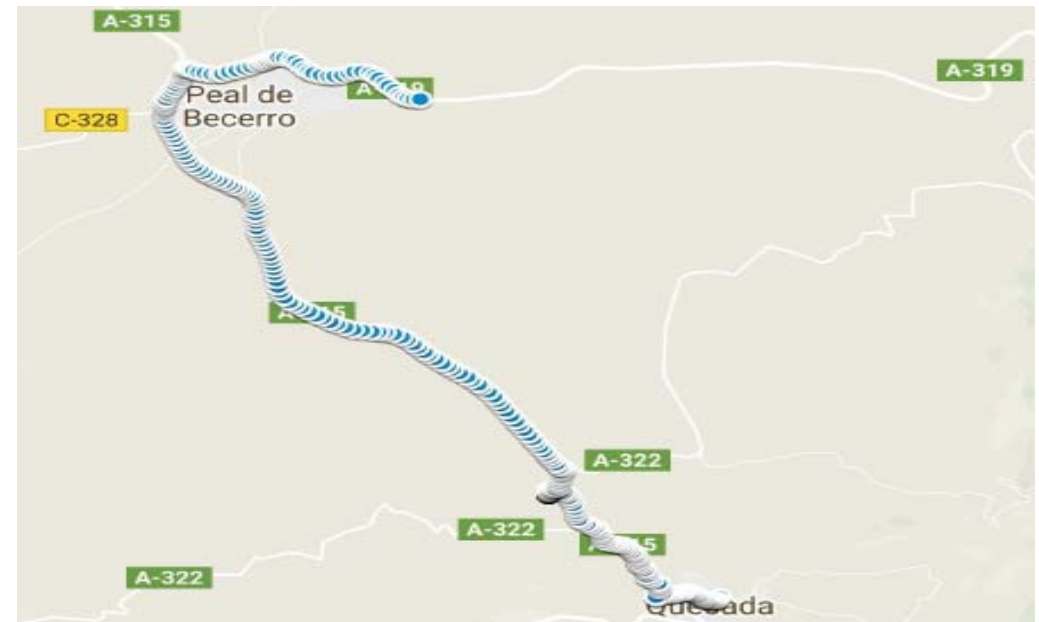

Position information placed on a map.

Fire detection

- During this test, we kept the system far from the fire during the first 8 seconds.
- From this moment, we have approached the fire and stepped back from it several times.

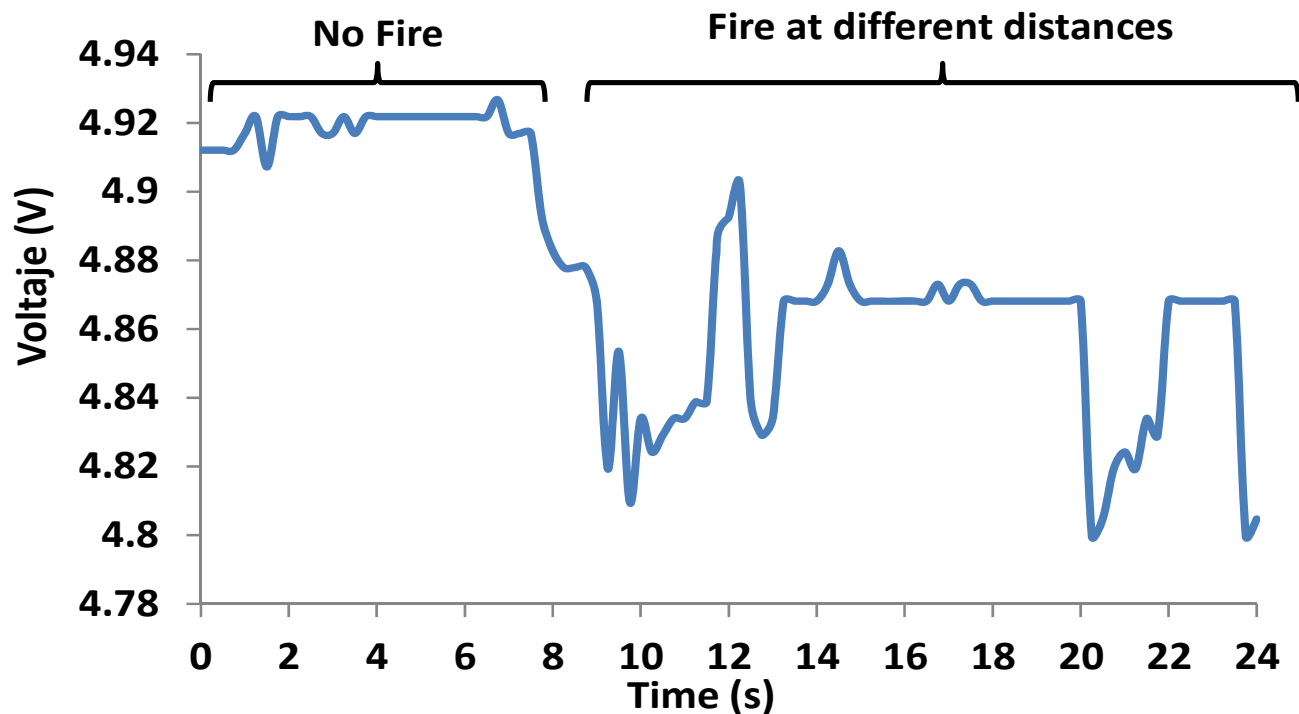

**Measurements
of fire detection**

Software Defined Networks for Traffic Management in Emergency Situations

Motivation

- Terrorist attacks, natural disasters and accidents require a fast evacuation of civilians in order to protect them and to facilitate the work of security forces.
- After registering these events, it is required the evacuation of thousands of people, millions in case of large cities.
- Technology can be employed as a solution to improve the evacuation process in emergency situations. Particularly, the functionalities offered by Software Defined Networks (SDNs) can be utilized alongside intelligent traffic signaling devices for this purpose.
- Smart cities utilize traffic signaling elements such as traffic lights and traffic signals that are becoming intelligent with the addition of IoT.
- They are being employed for measuring lines of cars, detecting traffic congestions and reducing waiting times.

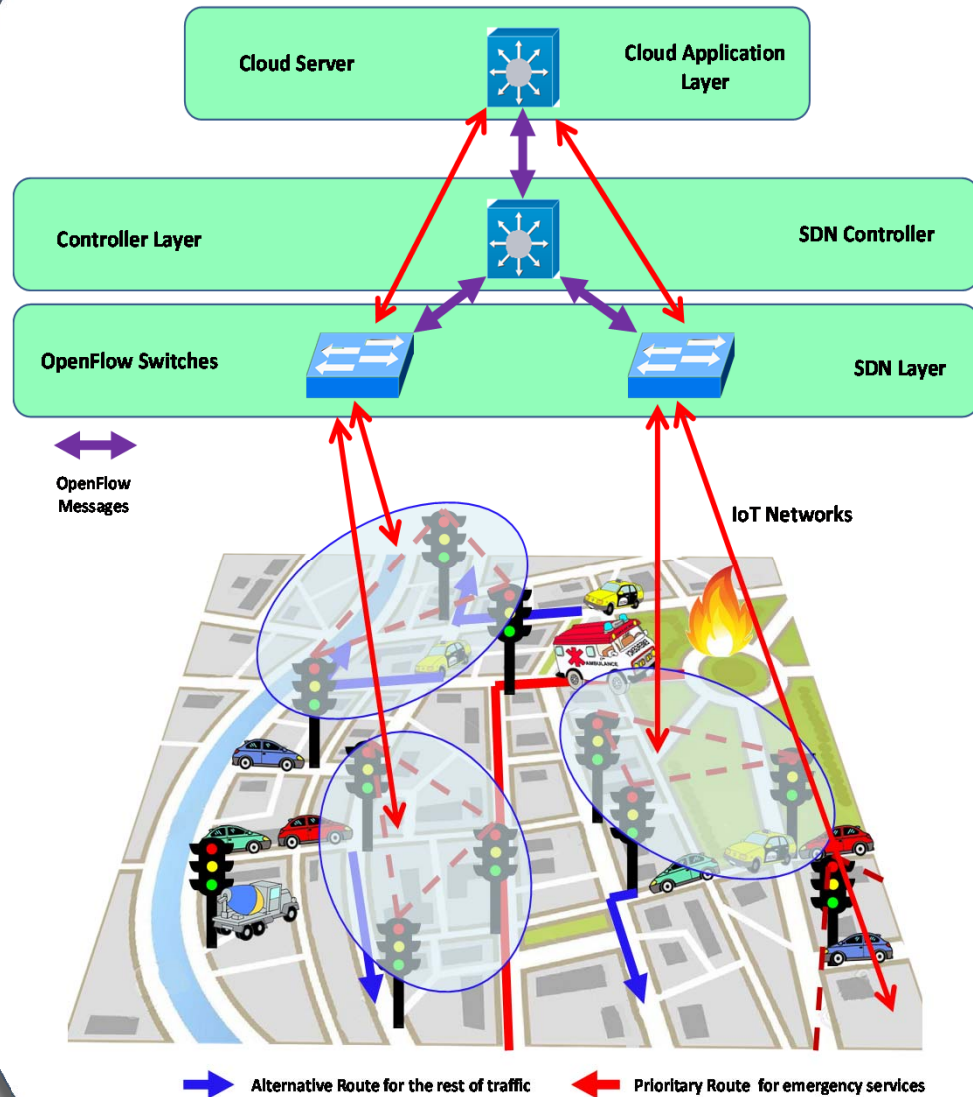

When an alert X with conditions C_X is received:

1. The area that generates the alert is located.
2. The alert X is tagged with the destination area D .
3. Checks C_X
4. It is necessary to mobilize the emergency resources (ER_X), $ER_1 \dots ER_N$ which are in the zones $D_1 \dots D_N$.
5. The SDN calculates the routes $S_1 \dots S_{N-D}$ (from this point named as R) with the shortest route so that if C_2 reaches at a node of S_1 , the system stops calculating the route $S_2 \dots D$.
6. The SDN creates the communication flows between the nodes of the routes R . In order to achieve this, the controller modifies the behavior of the nodes to divert traffic through alternative routes to R . Moreover, it gives priority to R so that the resources $ER_1 \dots ER_N$ reaches the destination D as quickly as possible.

Message exchange

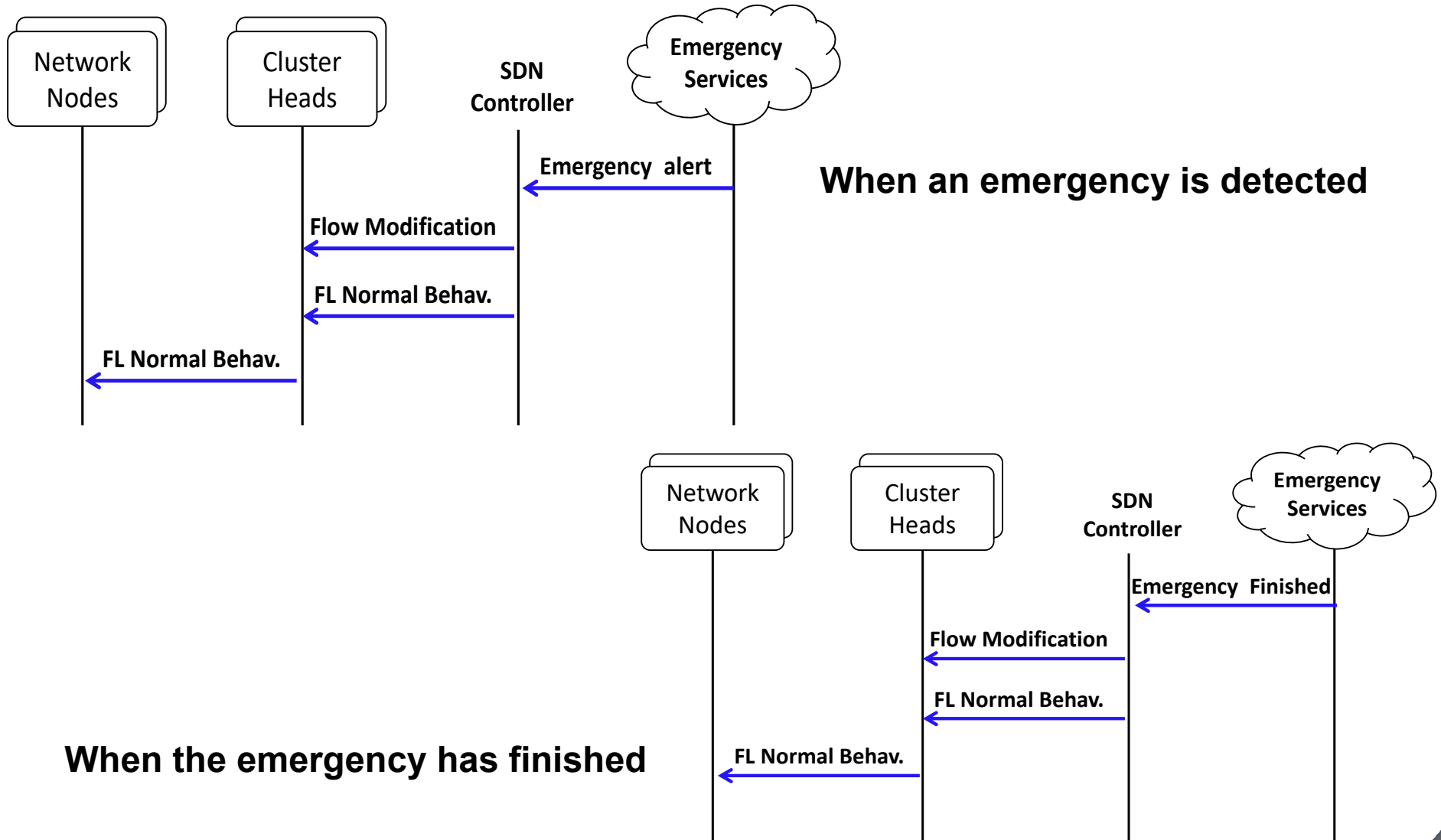

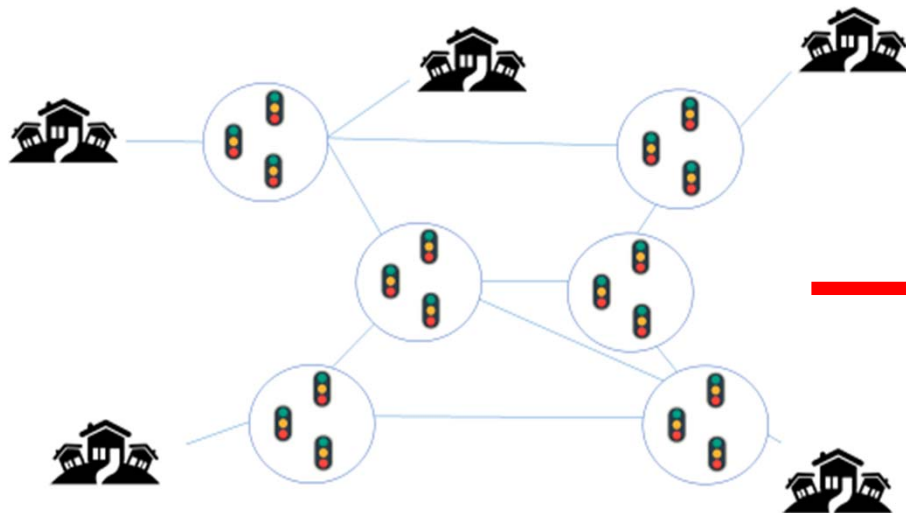

Scenario Simulated

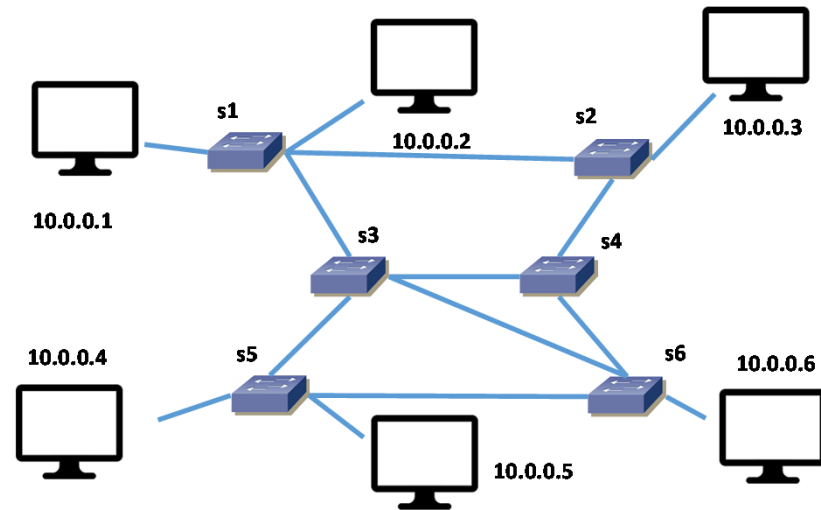

SDN Scenario

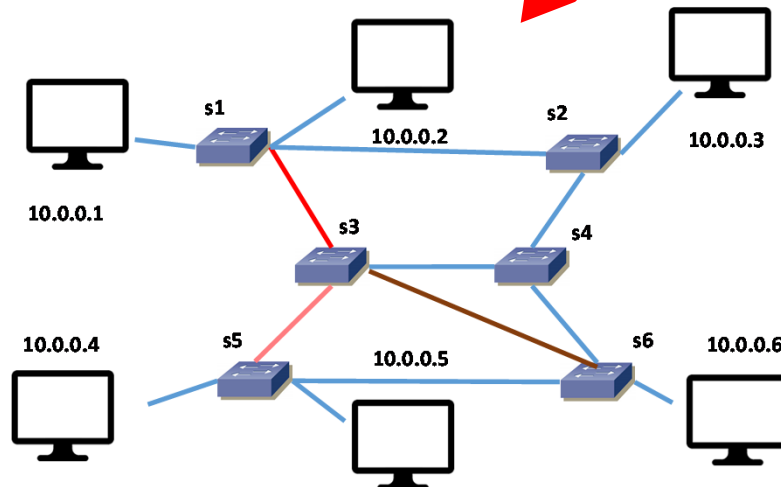

SDN scenario with simulated routes

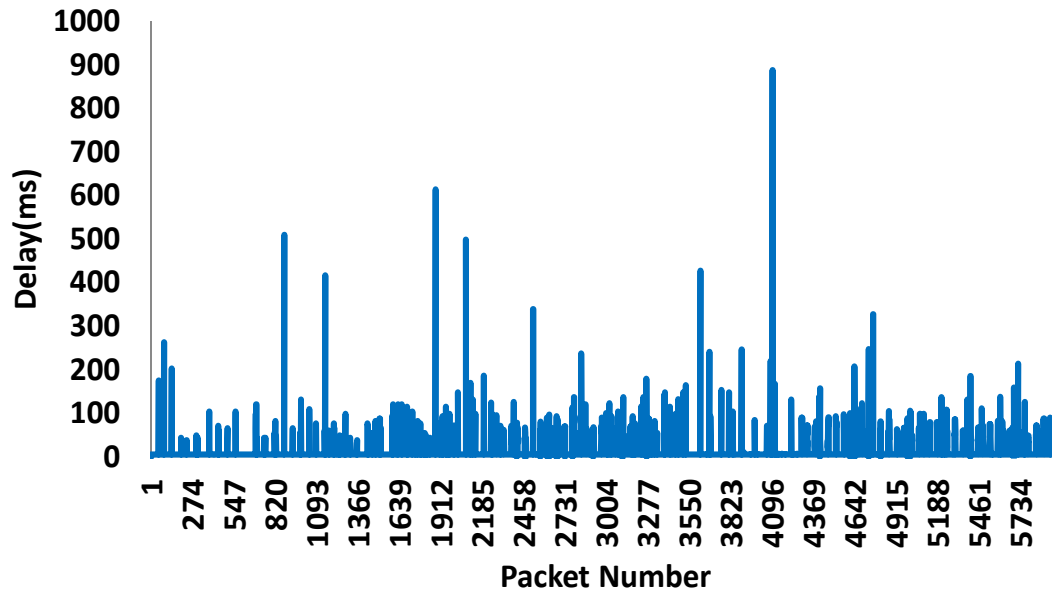

Delay that every single packet of normal traffic suffer in the network of scenario 1

Delay that every single packet of normal traffic suffers in the network of scenario 2

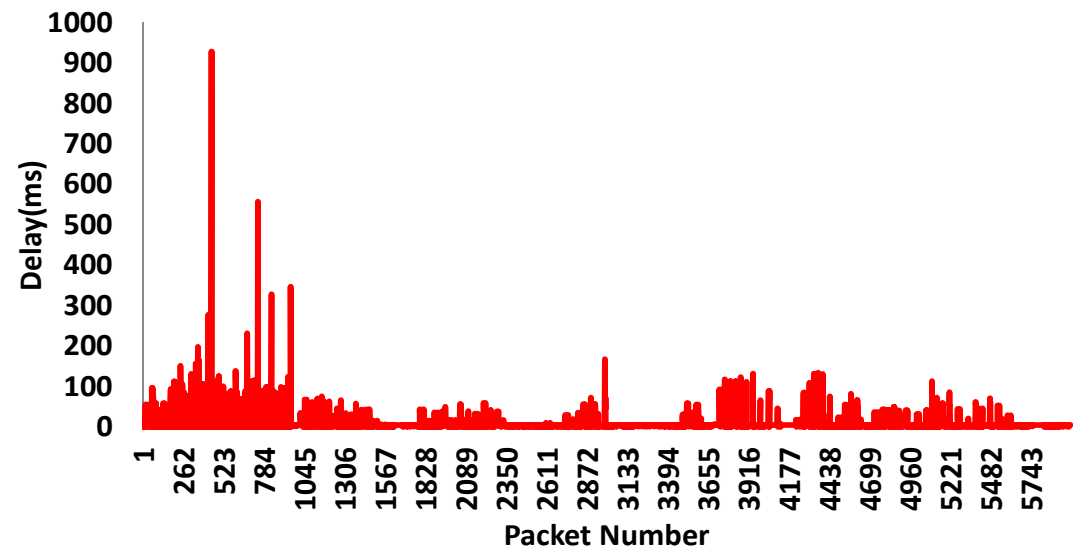

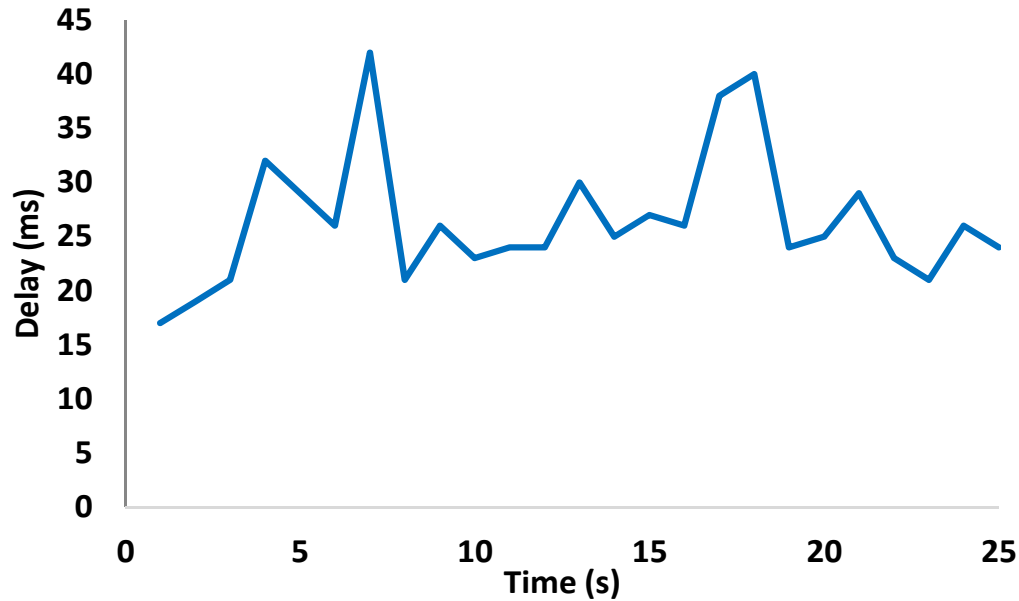

Delay of sending several emergency resource after an emergency event has been detected in scenario 1

Delay of sending several emergency resource after an emergency event has been detected in scenario 2

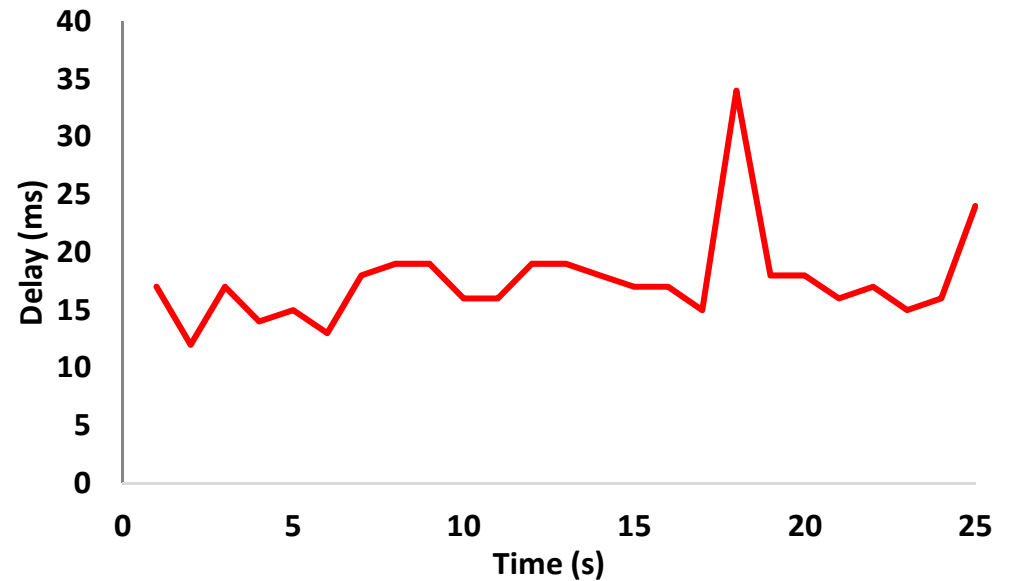

Performance of LoRaWAN Networks in Outdoor Scenarios

Motivation

- The critical point in many scenarios resides in the energy consumption due to the batteries which feed these things.
- This is why so-called LPWAN technologies, which permit low power transmission, have been developed. In return, the transmission data rate is reduced (e.g., hundreds of kbps) but it is still enough for many IoT applications.
- Because of their standardization and the usage of non-licensed spectrum, these technologies have become serious competitors of solutions based on cellular networks, such as Long Term Evolution-Category M (LTE-M) or NarrowBand-IoT (NB-IoT).
- The most popular LPWAN technologies are Sigfox, LoRaWAN, Ingenu TPMA, and nWave.

Components of a LoRaWAN network:

- **DIY multi-channel Raspberry Pi Gateway:** the chosen gateway is composed of a Raspberry Pi 3 Model B, an IMST ic880A concentrator with a maximum transmission power of 20 dBm and an 868 MHz antenna with 2 dBi gain.
- **End-Device:** the used end-device is based on the development board 'WeMos D1 Mini', which uses the ESP8266 chip. A shield with the RN2483A chip (up to 14 dBm of TX power), which implements both the physical and the MAC layers of the LoRaWAN standard, is connected to the WeMos board. These are supplied by a external power bank.

LoRAWAN NETWORK PROTOTYPE

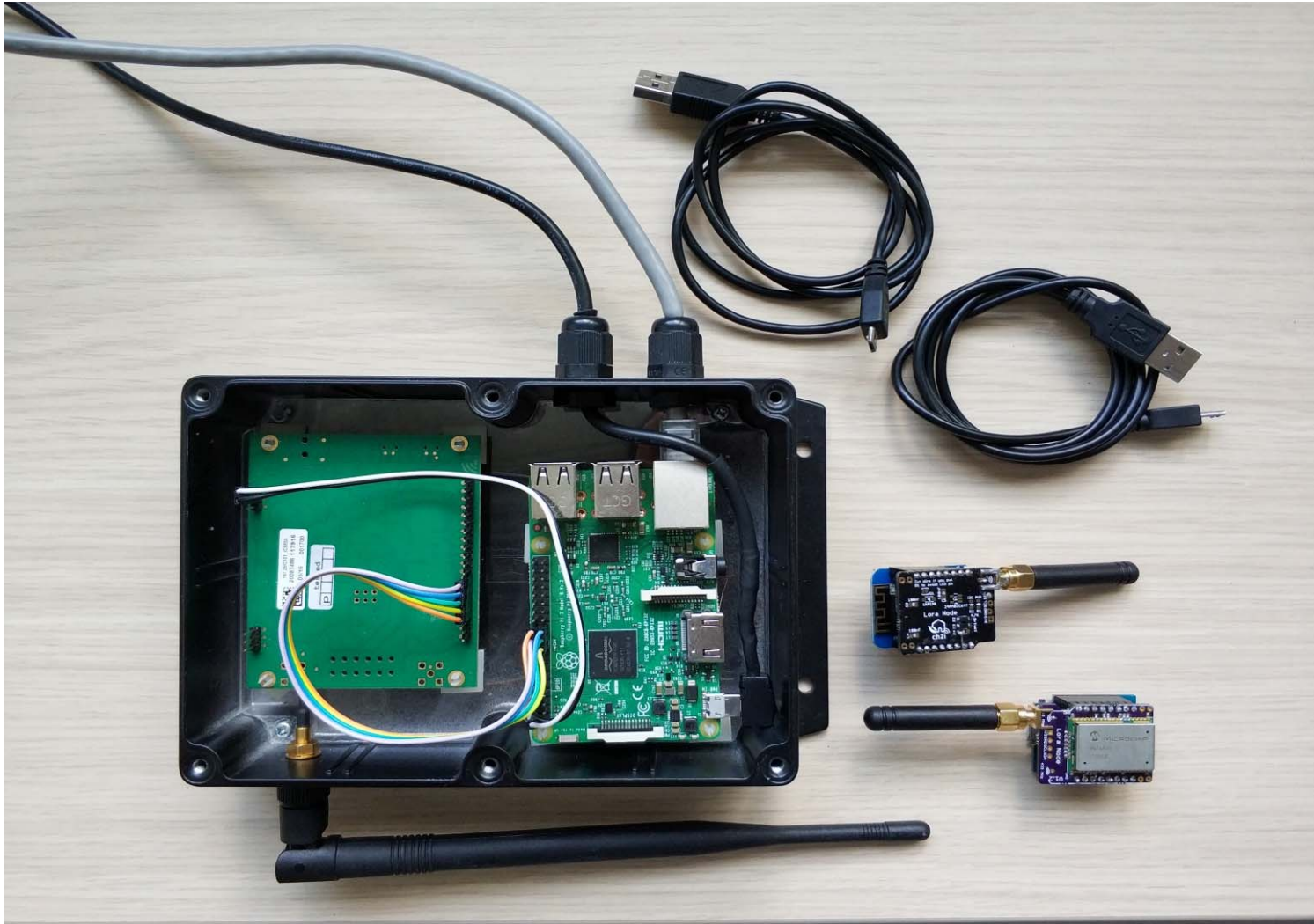

LoRa SERVER ARCHITECTURE.

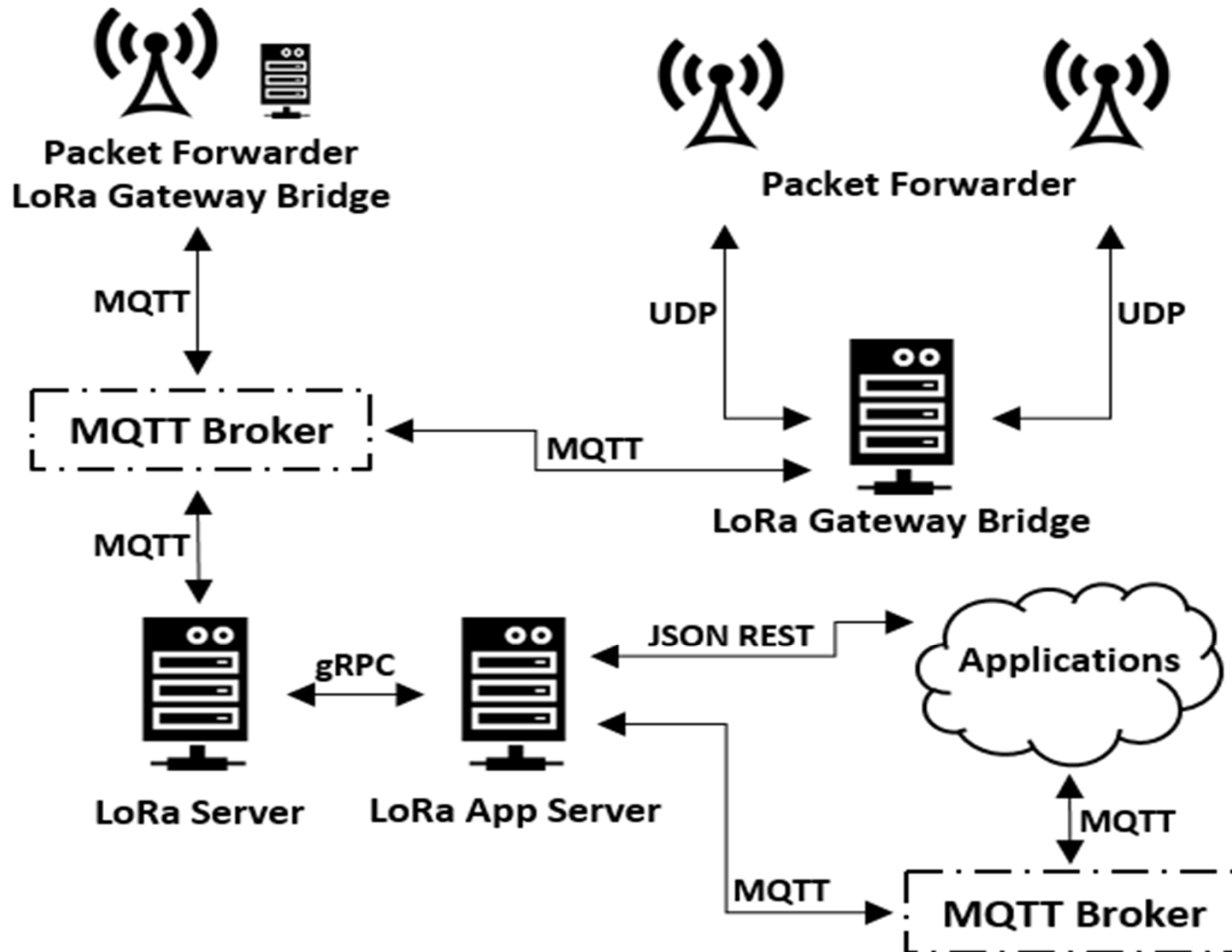

Highway Scenario

- The selected scenario is a road environment very similar to a highway.
- It has three lanes in each side and also, pedestrian and bike lanes which lets us walk to take the measurements.
- Measurements have been taken while walking. The evaluated parameters have been the SNR, the RSSI, the packets loss ratio and the coverage of the end-device.
- The road is place at the north area of Granada. The route has approx. 3.3 km with 74 m of gradient.
- The gateway, whose location is in (37.2136373, -3.5951833) geographical point, is placed on a bridge which crosses the road.



Highway Scenario Results

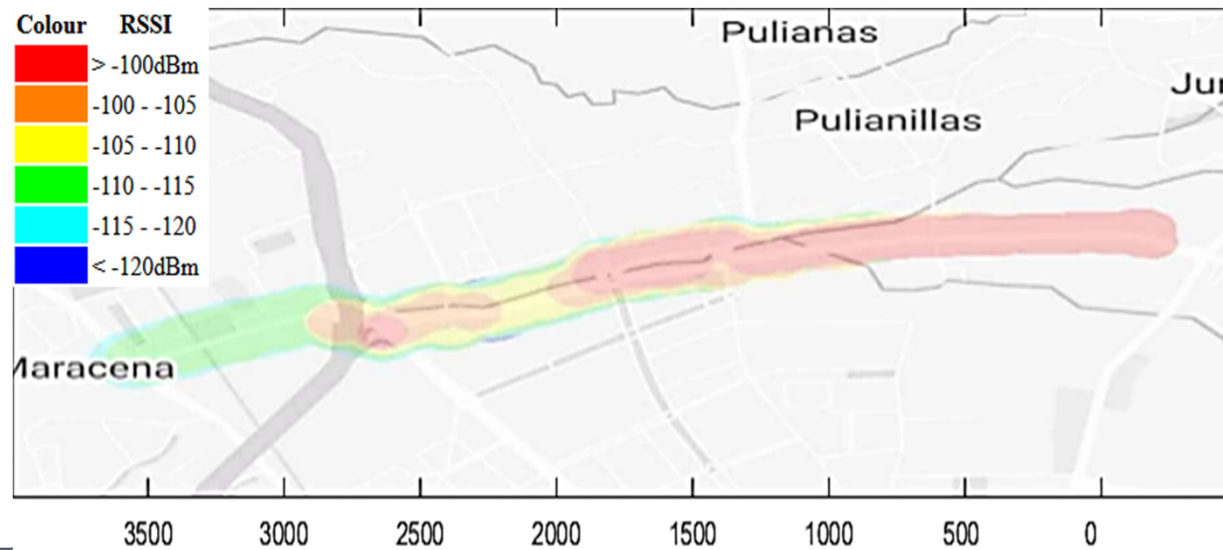
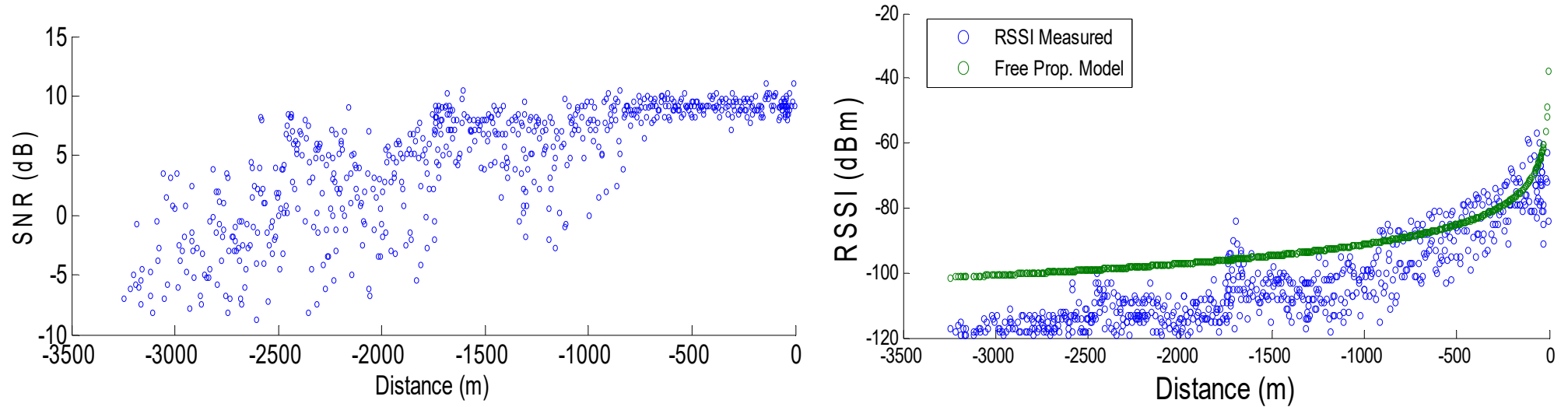

Coast Rural Scenario

- The gateway with coordinates (38.932457, -0.099974) is placed on the terrace of a second floor house (~9m of height).
- The building is found at Oliva, a coast village of Valencia (Spain).
- The maximum measured distance is about 615 meters. As we can observe, this scenario has very different conditions.
- The scenario is composed by several small houses and the climate conditions are also different (higher humidity).

Coast Rural Scenario Results

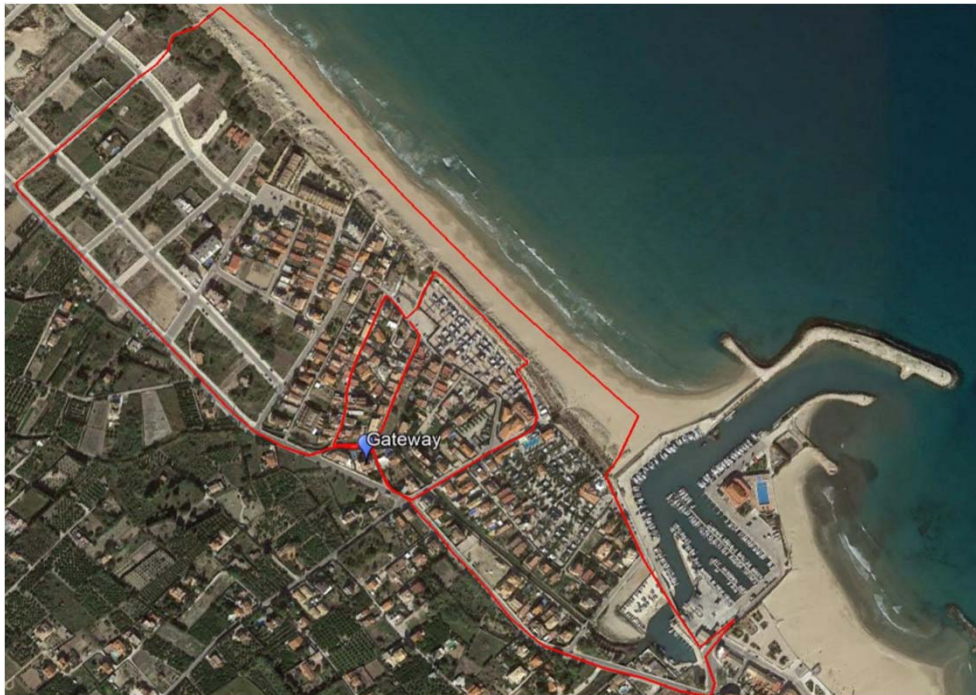

Coast Rural Scenario Results

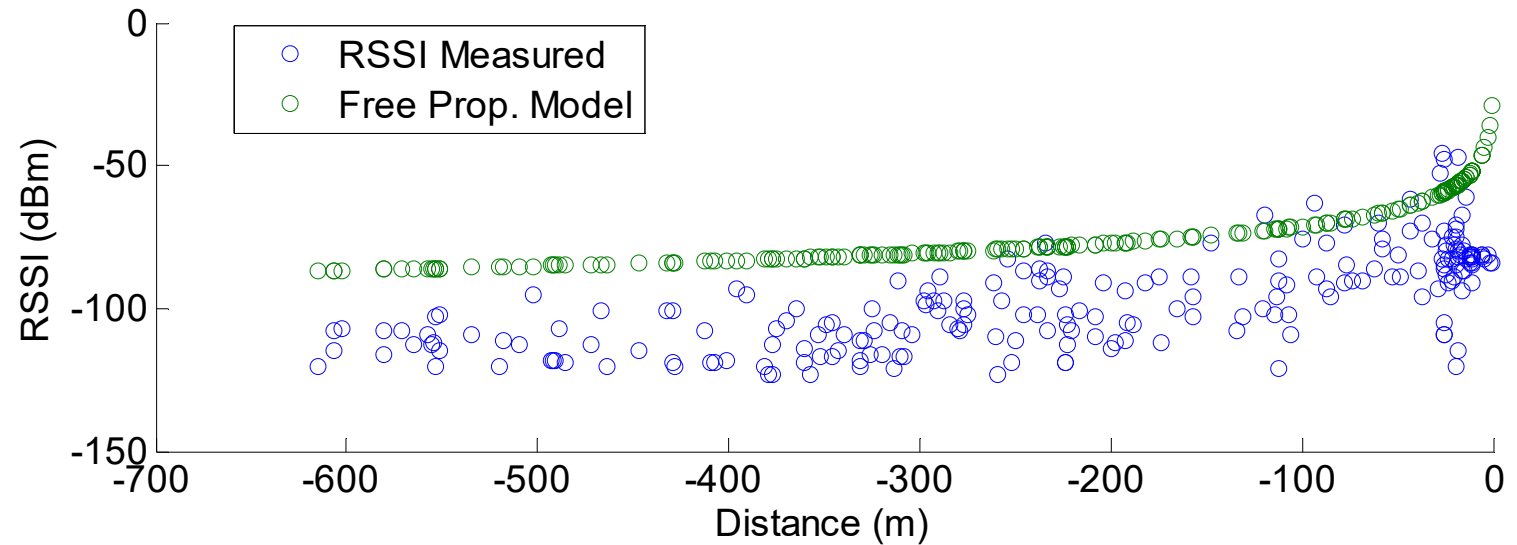
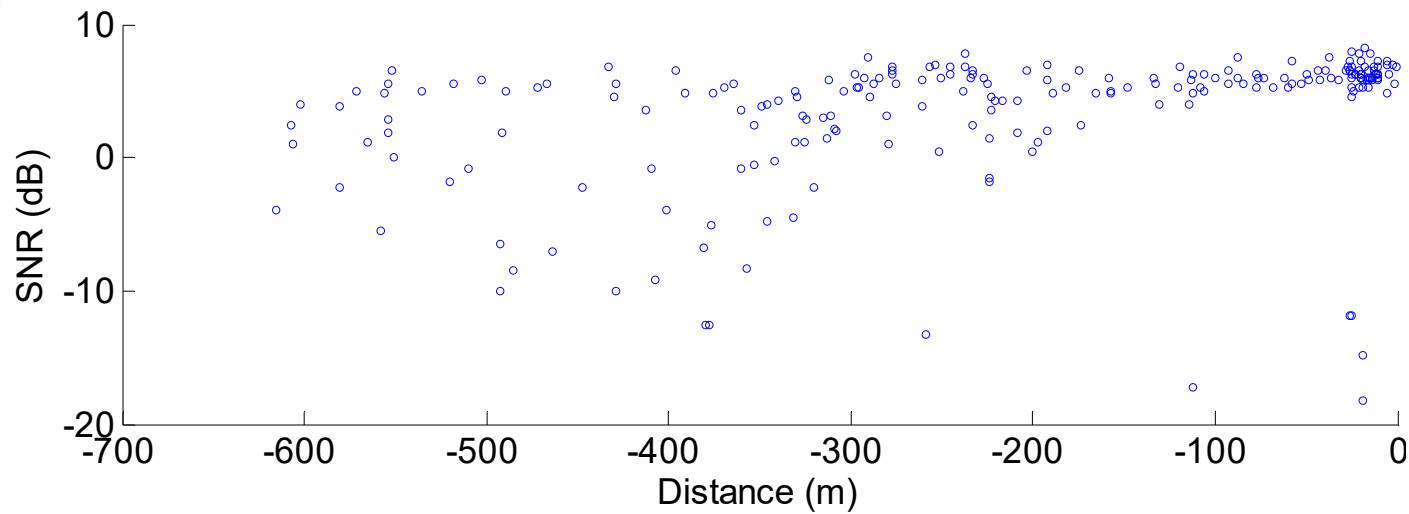

Smart Infant Incubator Based on LoRa Networks

Motivation

- Preterm Birth: born or occurring after a pregnancy significantly shorter than normal, especially after no more than 37 weeks”, where a full-term pregnancy (normal) is 40 weeks. Preterm births may be classified, according to the gestational age, in three categories:
 - moderate to late preterm (32-37 weeks),
 - very preterm (28-32 weeks)
 - extremely preterm (<28 weeks).
- According to WHO, more than 1 in 10 pregnancies end in preterm birth at a global level (estimated 15 million babies per year).
- Among the causes of death in children under 5 years old, preterm birth stands out and increases year-by-year overall in underdeveloped environments.
- Problems presented by premature babies are due to undeveloped organs and the lack of body mass.
 - Therefore, babies may have difficulties such as breathing (undeveloped lungs),
 - keeping a good body temperature.
 - Etc...
- An incubator must be well-equipped in terms of materials and technologies to face the several problems which can present a premature baby. For this purpose, an incubator should be able to measure parameters of the baby including **temperature, humidity, weight, luminosity and movements.**

Our Proposal

- This paper proposes a Smart infant incubator able to measure the progress of a baby.
-
- The system is composed by several sensors to measure:
 - Temperature,
 - Relative humidity of incubator and,
 - The progress of weight of babies under treatment. The weight sensors also allow monitoring the infant movements and its behavior which will help physician in the diagnosis.
- The infant incubator includes 2 different communication interfaces.
 - a Near Field Communication (NFC) interface that allows physicians checking the baby's evolution.
 - The second one is a LoRa interface that communicates the incubator in a bigger network to transmit the medical information to the medical data base.
- Finally the system has been tested in a laboratory environment in order to check the correct operation of sensors and the entire system. Finally the LoRa network is tested to check the coverage in indoors.

- To implement this proposal we used LoRa technology since it presents better performance to cross walls and floors.
- To implement our network, we essentially need a Gateway LoRa–Ethernet to connect all the available Lora Nodes and to transmit the medical data to the data base (DB).
- Finally, the data will be available to the physicians and nurseries through their tablets or computers in hospitals.

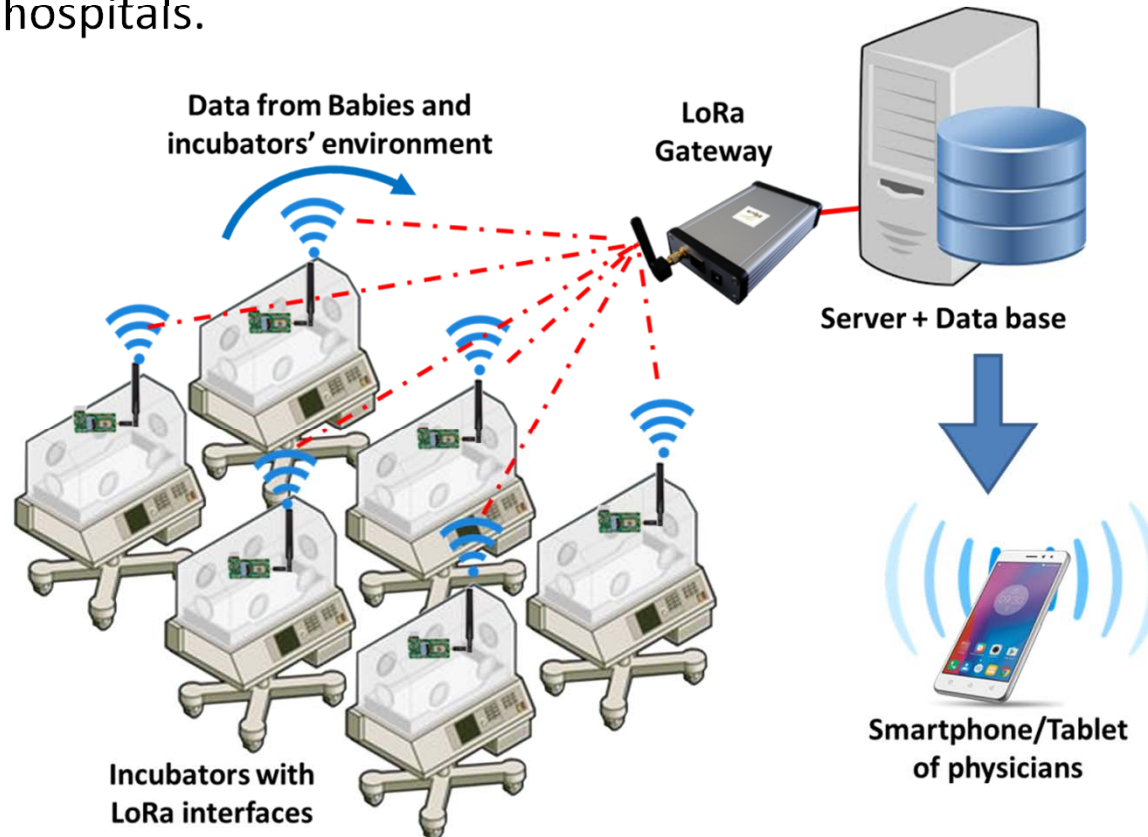

**Network
architecture**

General Description

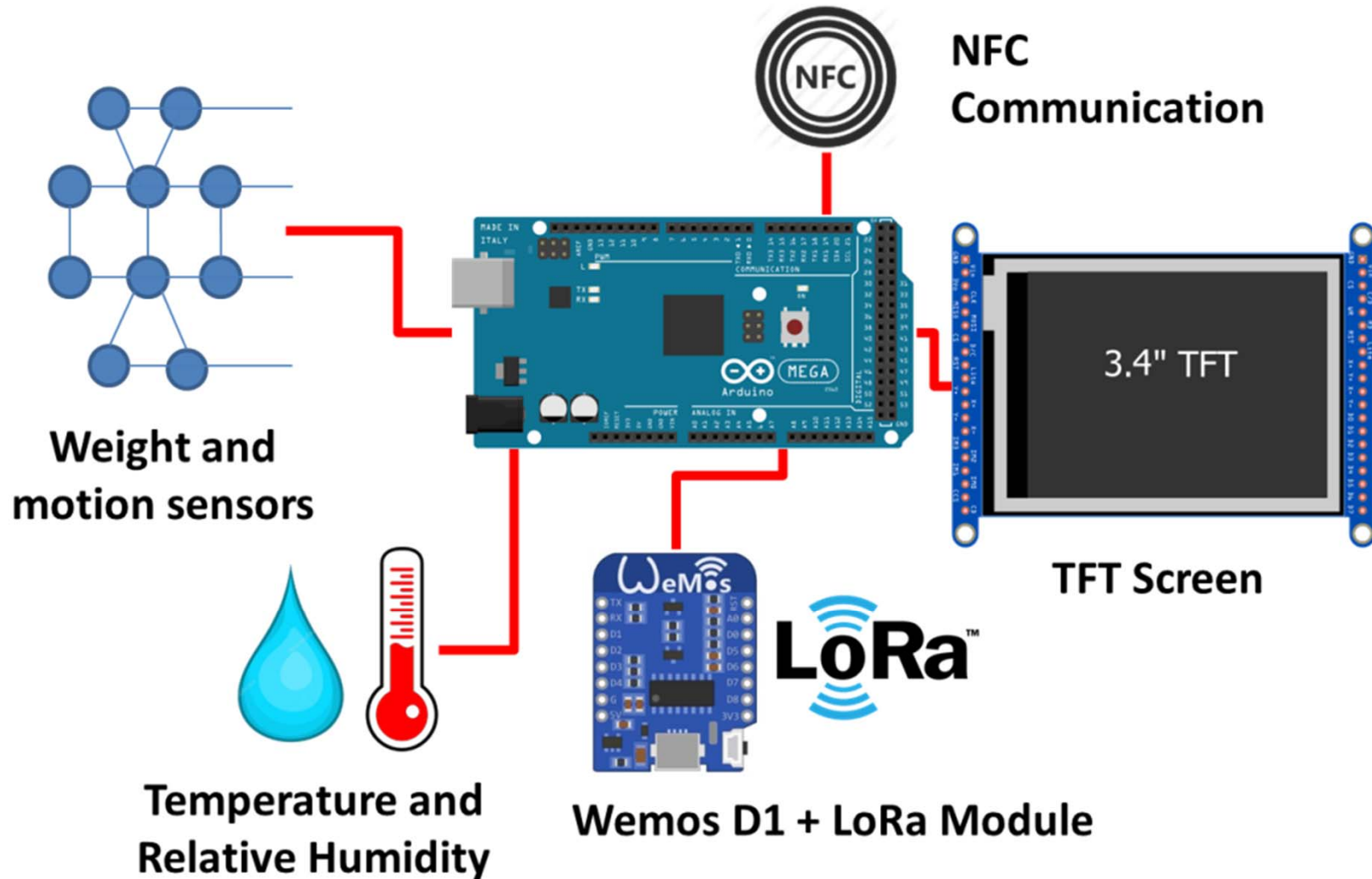

- The devices used in this case are the following:
 - **DIY multi-channel Raspberry Pi Gateway:** the chosen gateway is composed of a Raspberry Pi 3 Model B, an IMST ic880A concentrator and an 868 MHz antenna
 - **End-Devices:** the used end-device is based on the development card Wemos D1 Mini which uses the ESP8268 chip. A shield with the RN2483A chip, which implements both the physical and the MAC layers of the LoRaWAN standard is connected to the Wemos D1 Mini card.

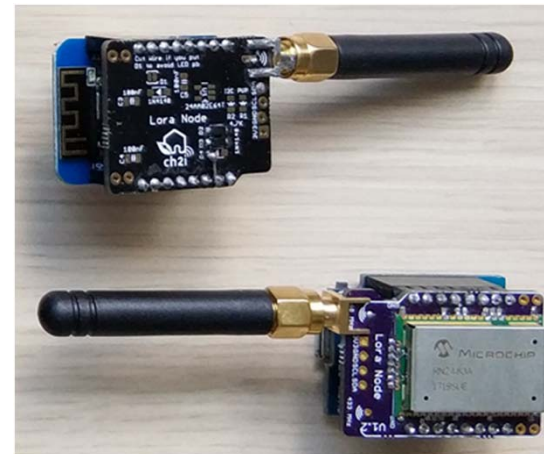

Sensors measurements

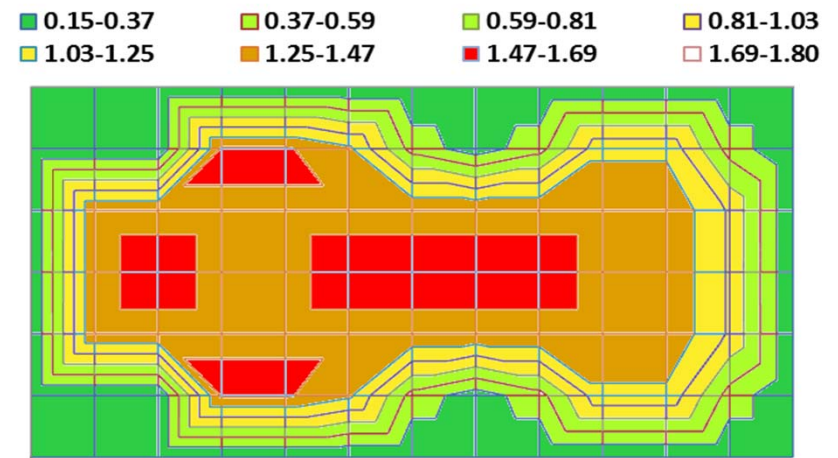
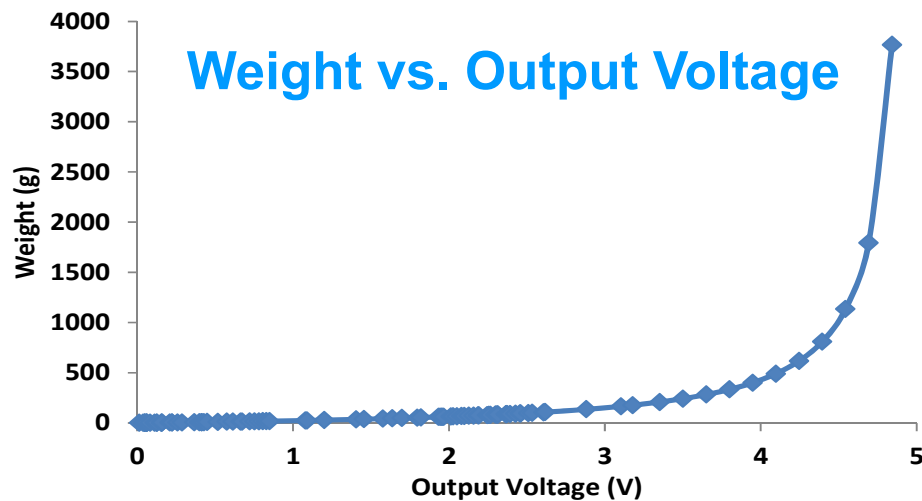
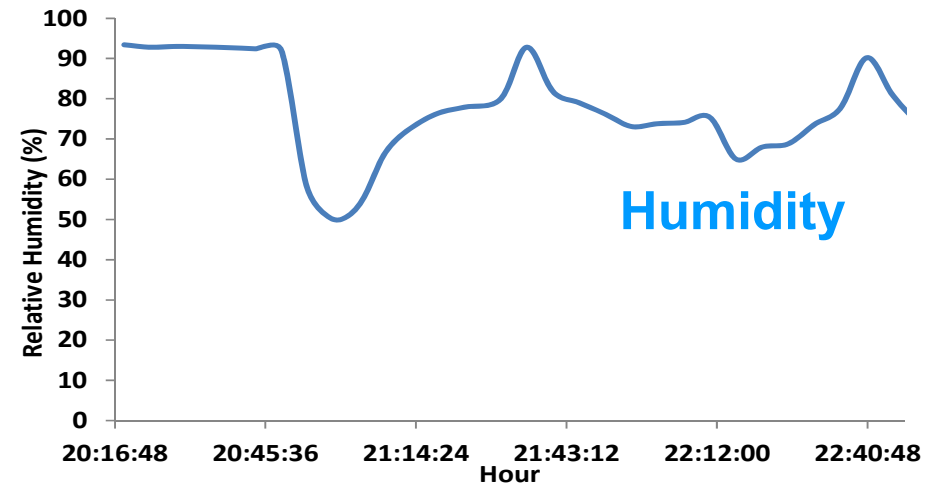
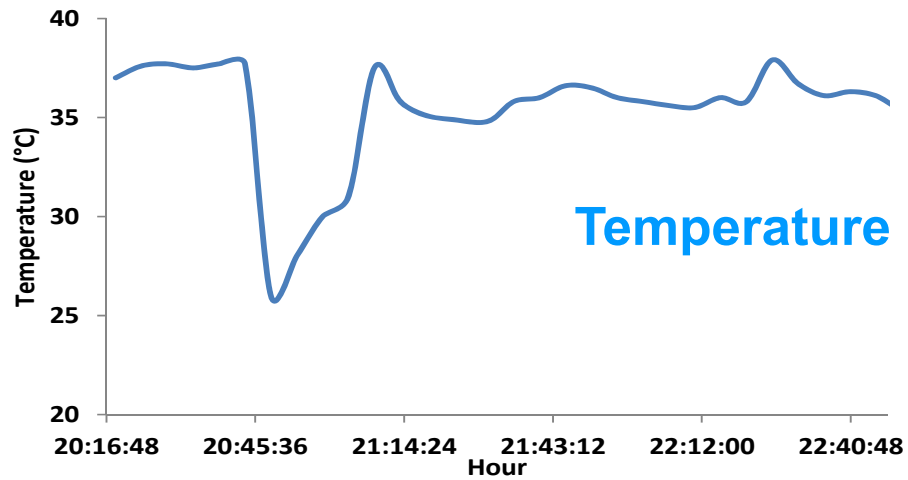

Network measurements

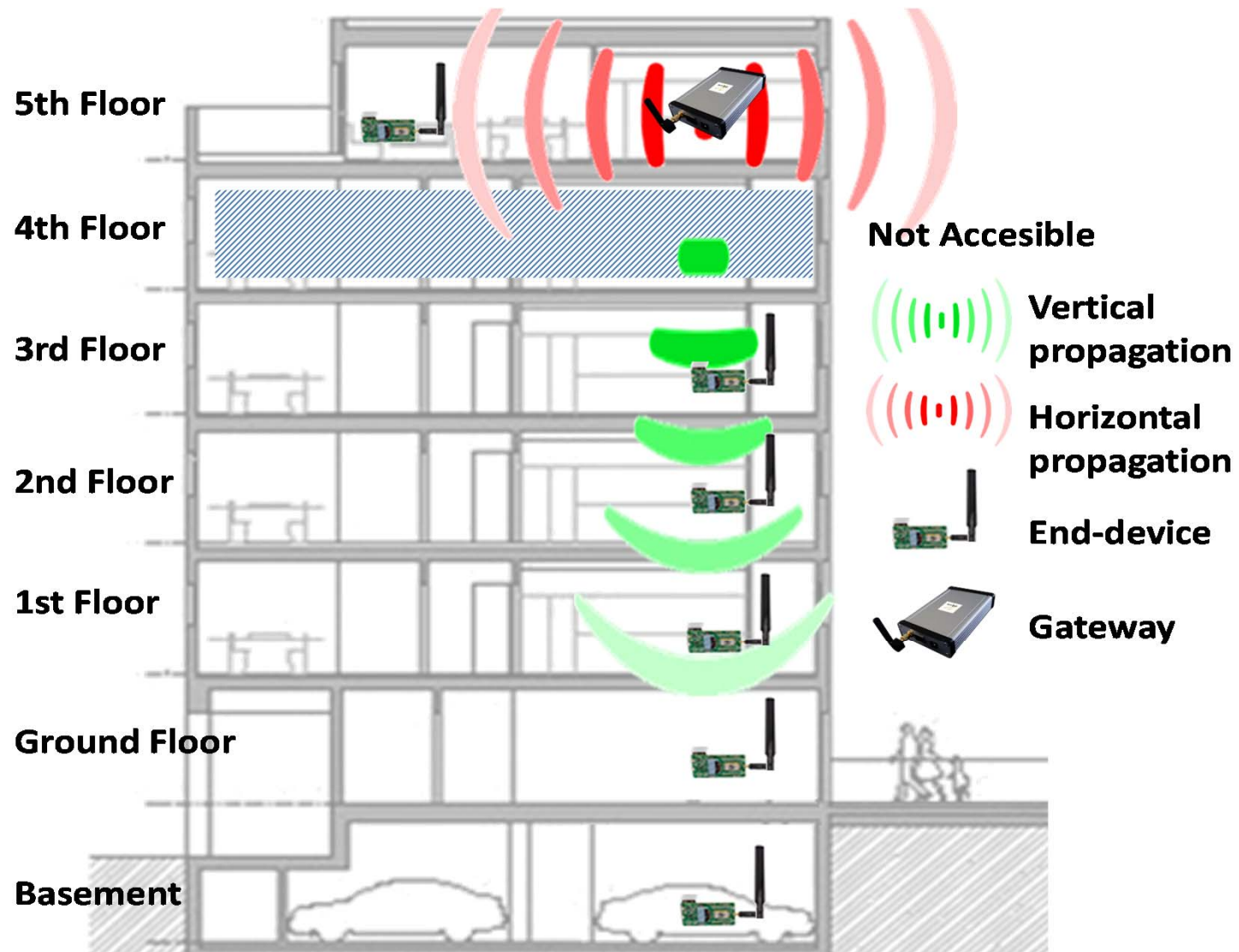

Network measurements

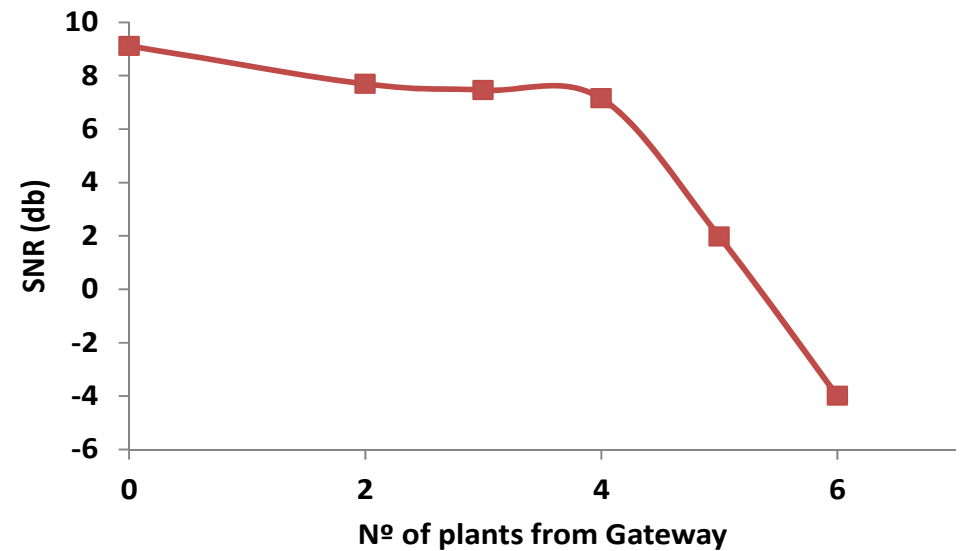
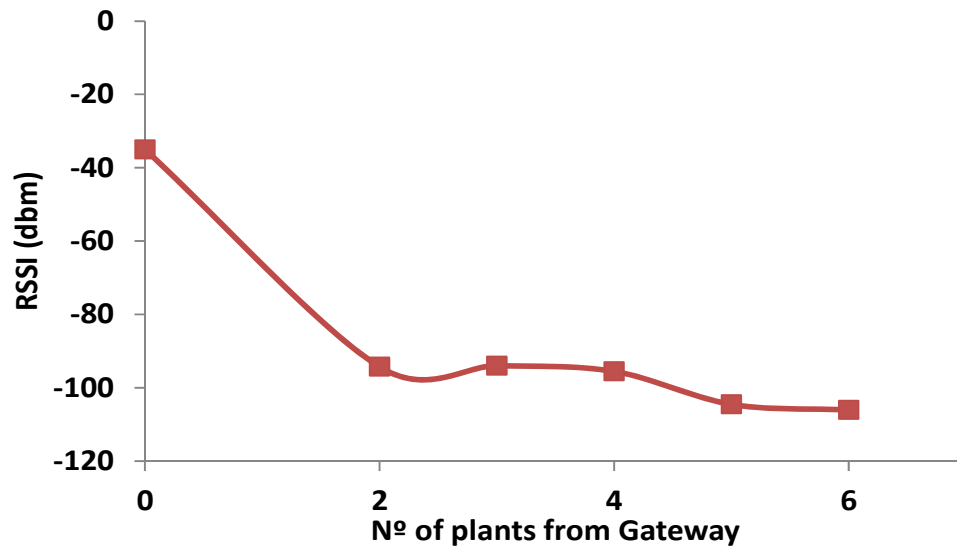
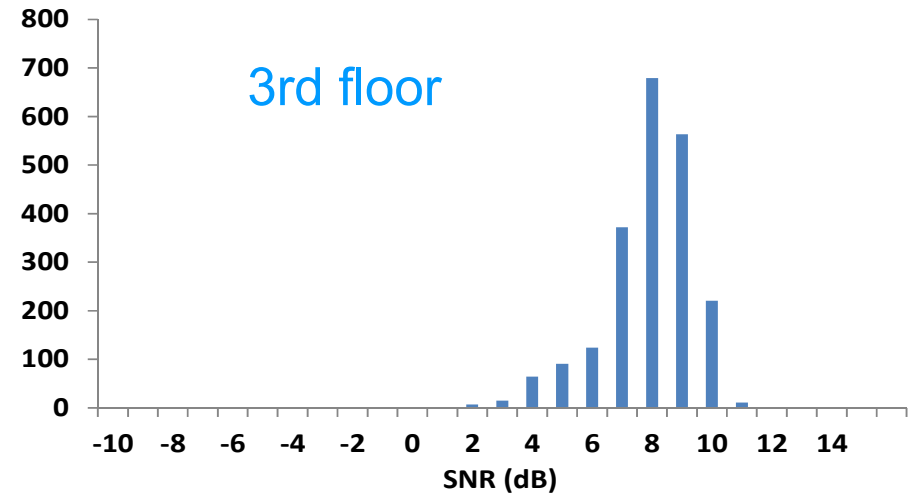
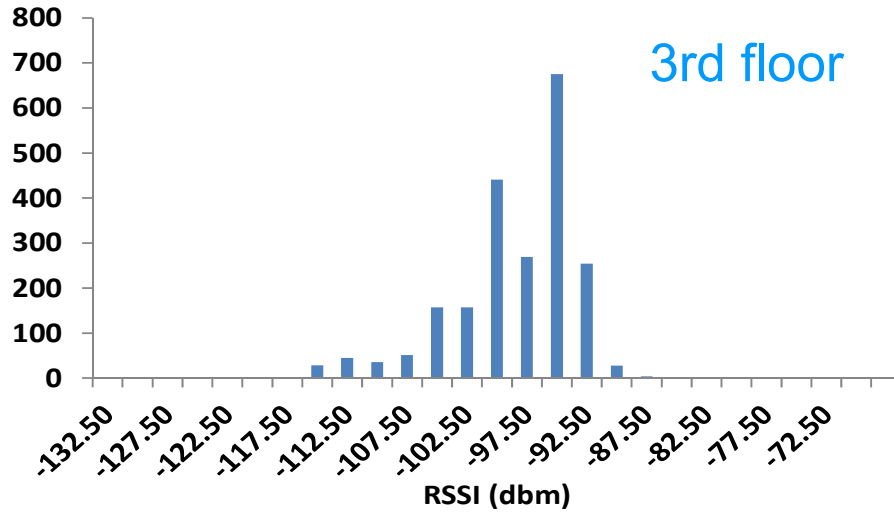

Collaborative LoRa-Based Sensor Network for Pollution Monitoring in Smart Cities

Motivation

- Urban air pollution is a serious problem in many large cities on the planet.
- The intense traffic, together with factories that do not control their emissions, turns the air of cities of the world into clouds of smog.
- Air pollution will become the main environmental cause of premature mortality in the world.
- It is estimated that by 2050, the number of premature deaths resulting from air pollution will reach 3.6 million each year on the planet.
- Pollution deaths are usually linked to heart disease, stroke, or obstructive and chronic lung disease. It is also related to lung cancer and acute respiratory infections.

Our Proposal

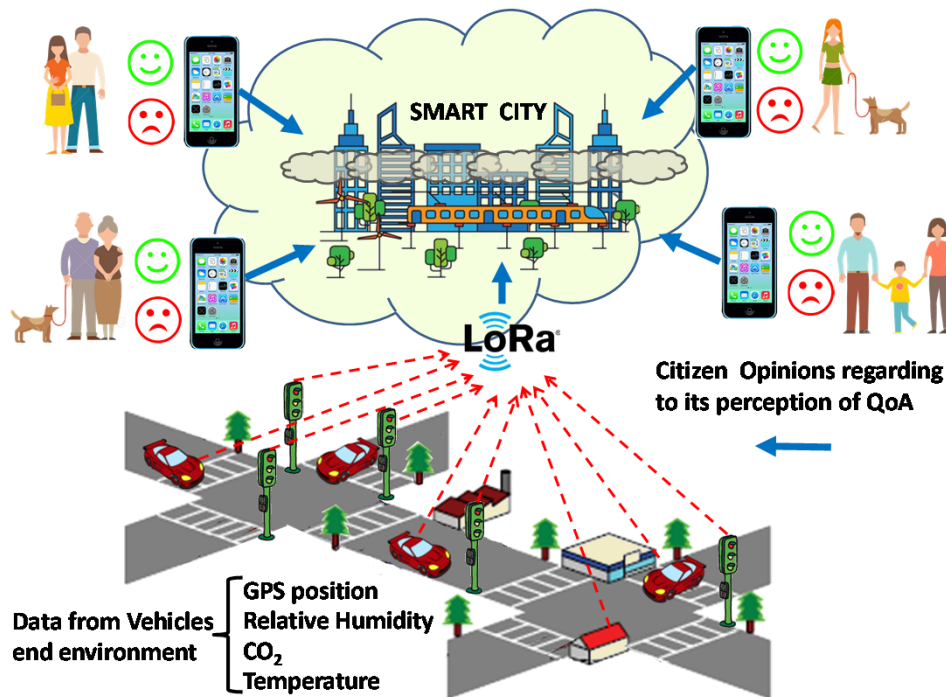

Collaborative LoRa-Based Sensor Network for Pollution Monitoring in Smart Cities

- Smart city → collaborative entity capable of combining data from different sources to make decisions and take measures to improve a situation.
- We focus our proposal on the control of pollution in cities. We consider: Wireless nodes based on LoRa
 - in vehicles
 - Fixed nodes installed in traffic lights and lampposts.
- Monitor the evolution of temperature, relative humidity and CO₂ concentrations at the established points and combine all these data to build real-time maps of the evolution of these parameters.
- The proposed network becomes collaborative, as the opinion of citizens is introduced into the network and considered to make decisions on the actions to be taken.

Smart City framework

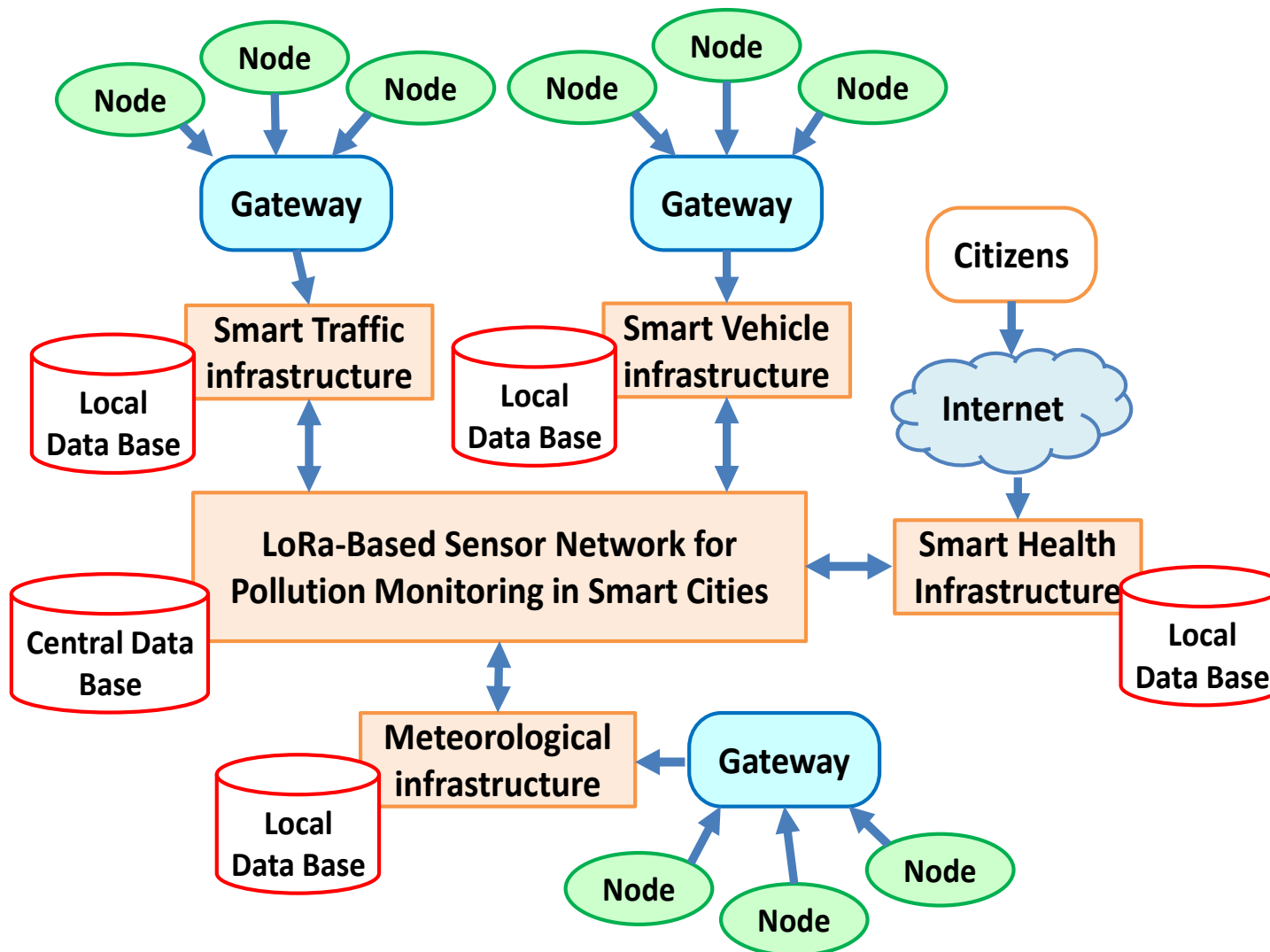

LoRa Node

- To implement each node, we use a TTGO T-Beam node. It is built around the ESP32 chip. It has 4MB of SPI flash.
- It operates at 433 MHz, 868 MHz and 915 MHz, in our case we use the European ISM band at 868 MHz.
- Our TTGO T-Beam node includes two antennas. A GPS ceramic antenna connected to a u-bloc NEO-6M GPS module and another LoRa antenna with SMA connector.
- It uses a LoRa chip from the HopeRF RFM9X family. The node has a total of 26 pins with GPIO, ADC, VP/VN, DAC, Touch, SPI, I2C, UART and Lora.
- Finally, the node can be feed by batteries.



Collaborative Algorithm

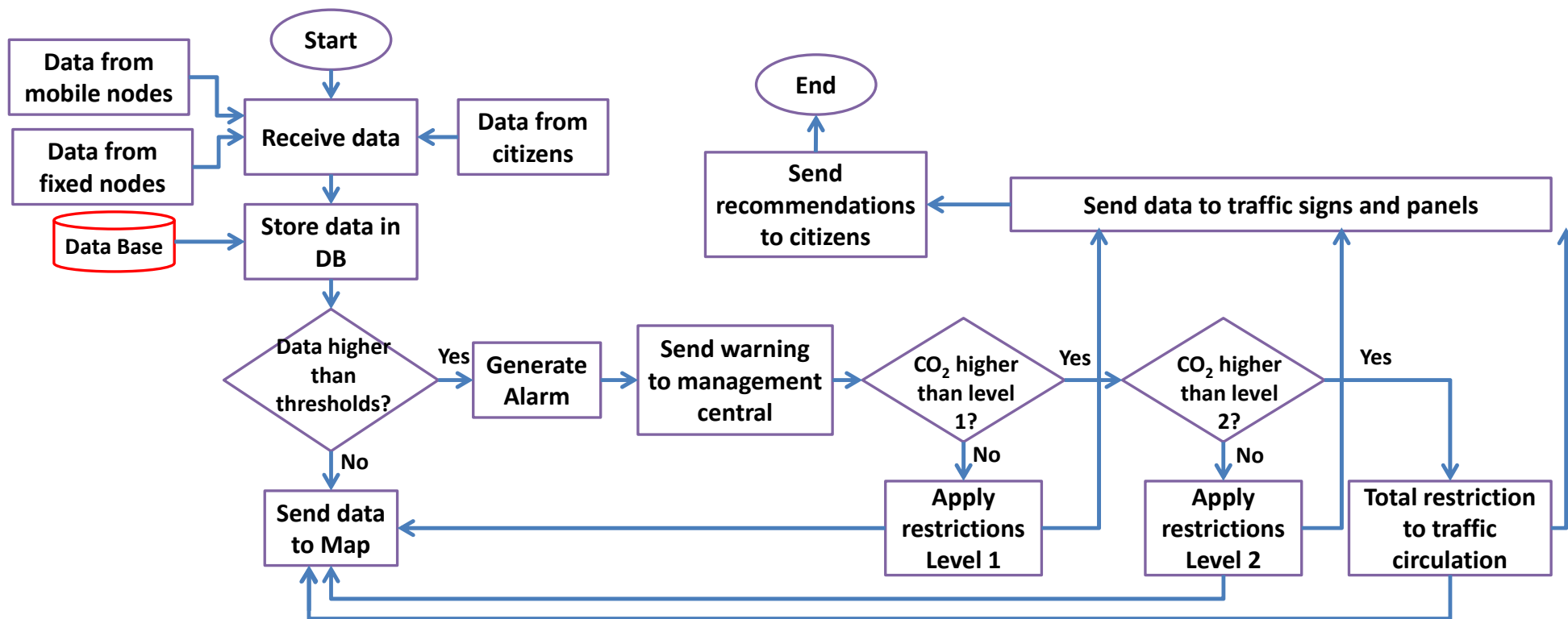

RSSI coverage over the measurement scenario

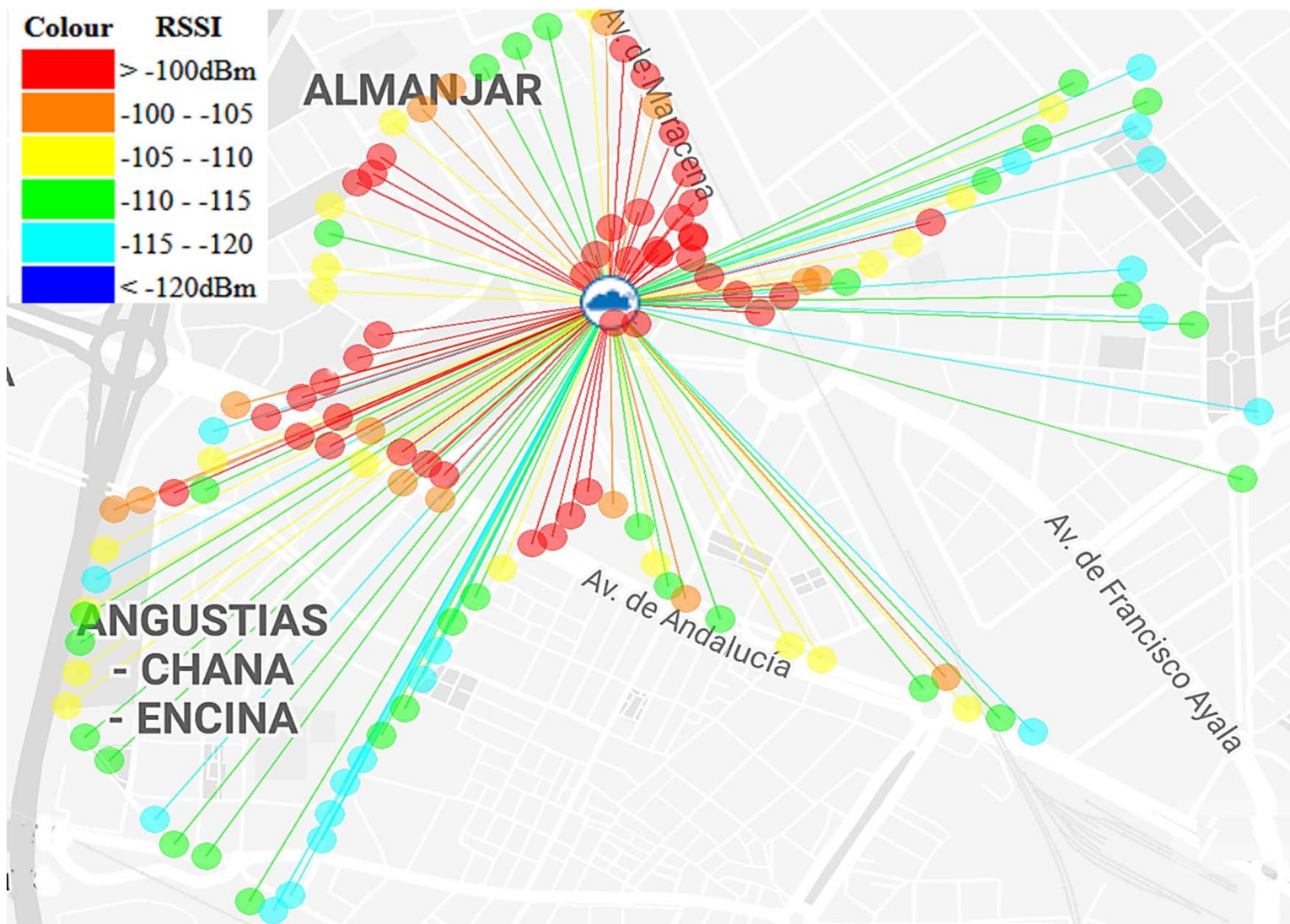

Network Measurements

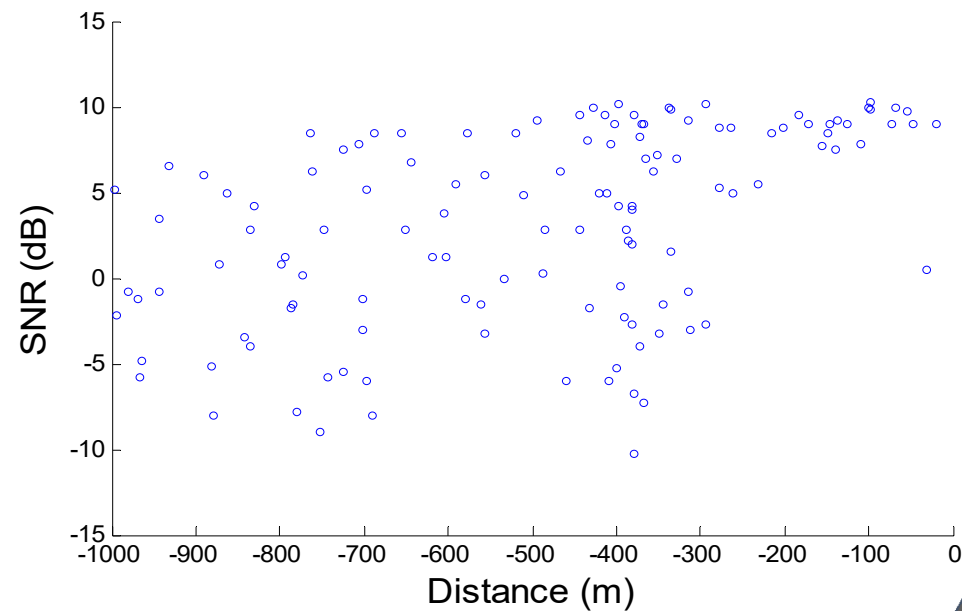
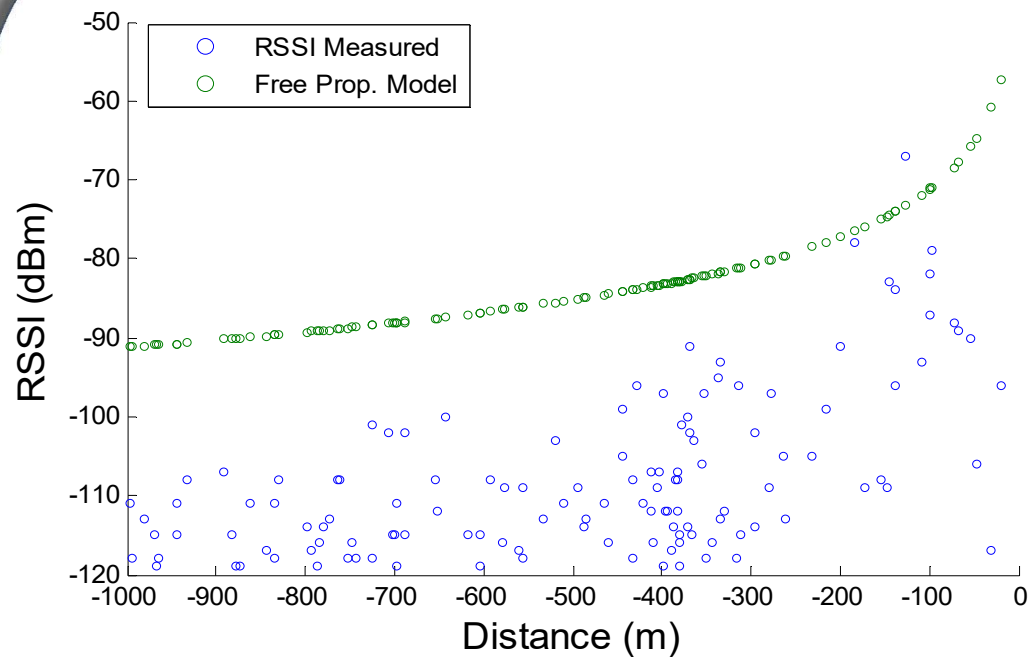

Environmental parameters

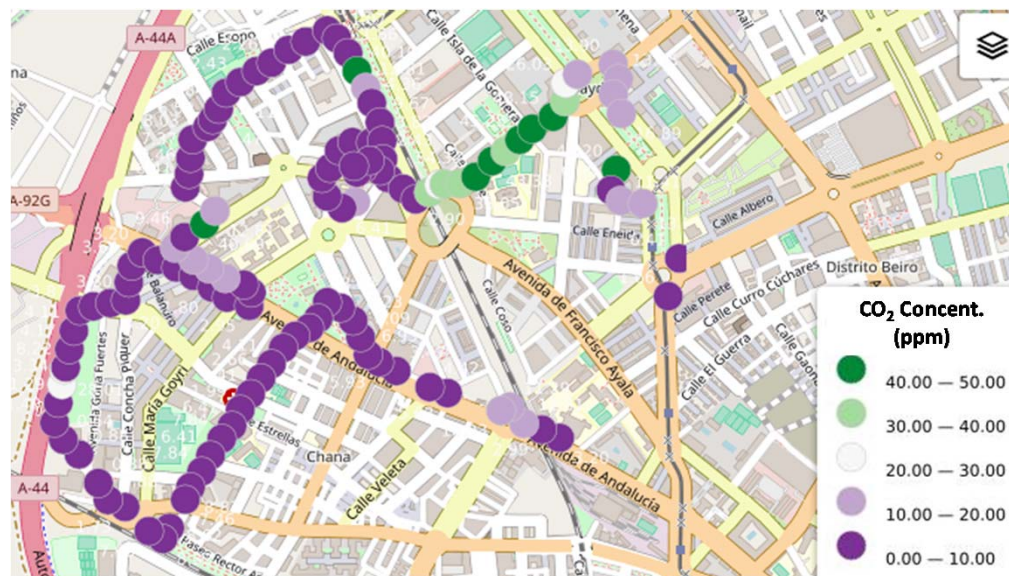
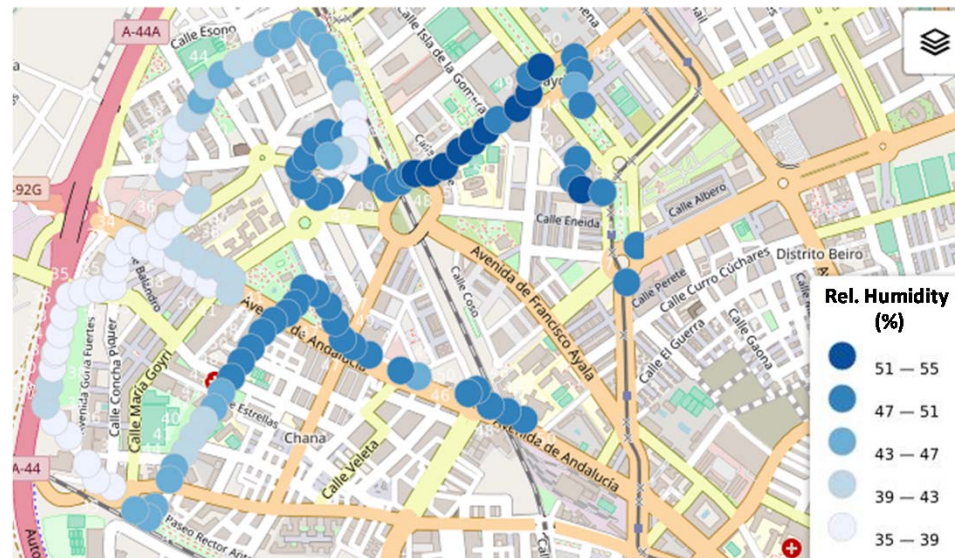
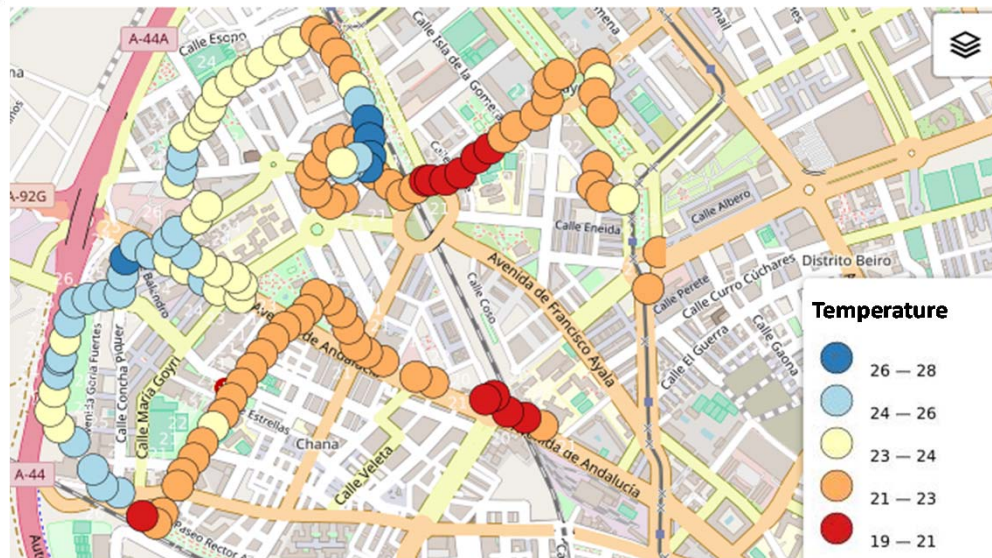

Integration of LoRaWAN and 4G/5G for the IIoT

LoRaWAN-EPC Secure Integration Proposal

- Mobile operators may be interested in deploying LPWAN networks in order to extend their market to massive IoT applications such as:
 - smart metering,
 - remote monitoring,
 - smart city applications, and
 - asset tracking in the logistics industry.
- Since mobile network operator (MNO) networks have already deployed nationwide or even international WAN networks, including their operation and maintenance (O&M) platforms, it would be extremely beneficial to integrate IoT devices into their current mobile networks.

LoRaWAN-EPC Secure Integration Proposal

- We propose a novel and seamless integration of LoRaWAN with the 4G/5G core network (i.e., EPC).
- Features:
 - LoRaWAN end devices and servers are not modified, since the PHY and upper layers are kept untouched.
 - LoRaWAN security is maintained (data integrity is ensured up to the network server, and data confidentiality is ensured up to the application server.)
 - The LoRaWAN gateway acts as a combination of UE and eNB for signaling with the Evolved Packet Core (EPC).
 - For the latter control procedure, the LoRaWAN gateway is seen as an eNB from the EPC point of view, but it also includes the computation of the required security parameters.
 - Thus, there is only one LTE bearer between the gateway and the EPC.
 - This bearer is used to send all the data from/ to the LoRaWAN end devices that are camping under the gateway coverage area.

LoRaWAN integration with a 4G/5G mobile network, both user and control planes, including the signaling between the LoRaWAN gateway and the EPC.

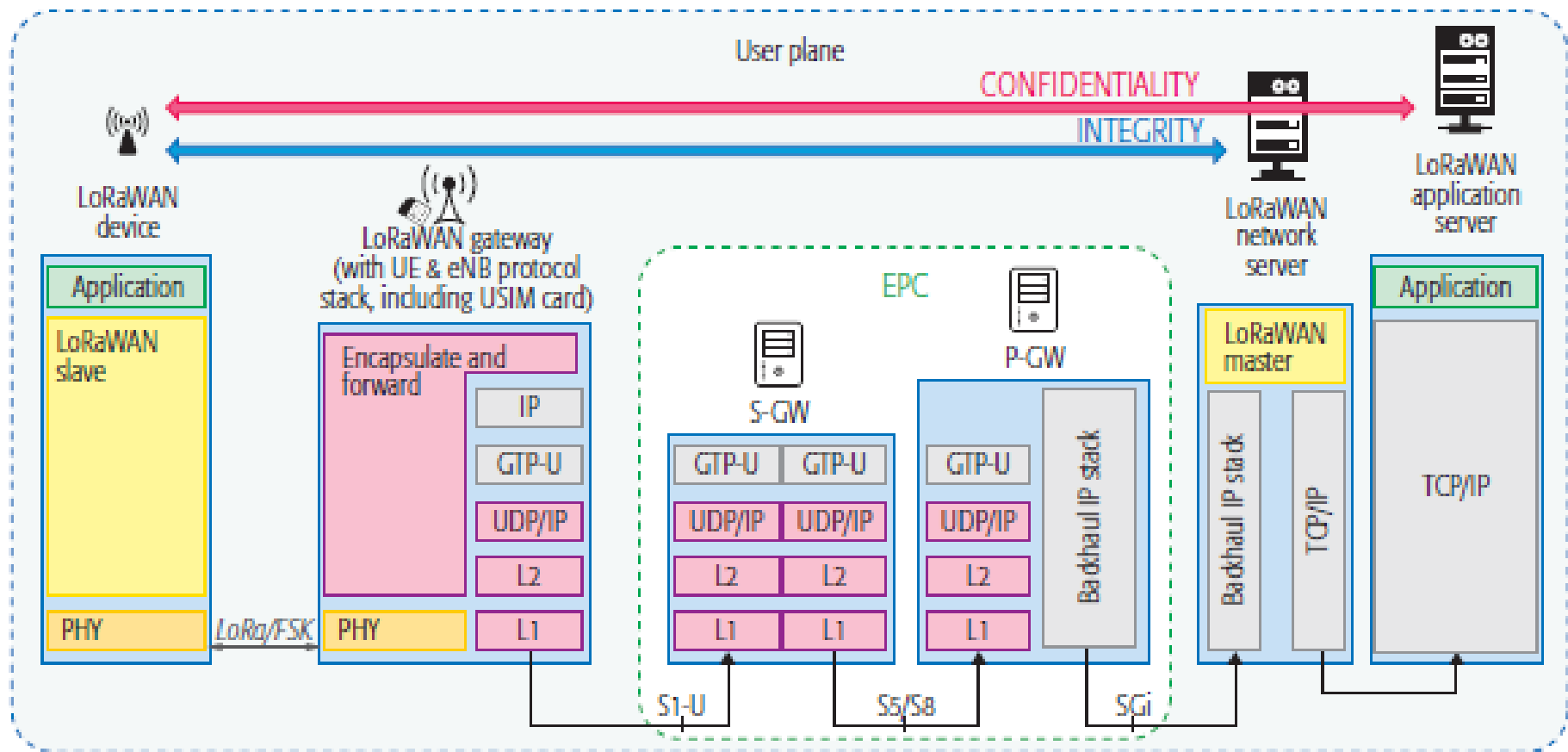

Main entities, user and control planes, protocol stacks, signaling messages, and interfaces.

LoRaWAN-EPC Secure Integration Proposal

- LoRaWAN devices and servers maintain their original protocols and signaling procedures.
- The EPC is also not modified, so the 4G/5G security procedures are unaffected.
- In the control plane:
 - Our proposal only requires the modification of LoRaWAN gateways, which maintains their LoRaWAN protocols from the end-device perspective, but now includes the eNB protocols from the EPC point of view for both control and user planes.
 - End devices and the EPC are not modified, therefore achieving a seamless integration of LoRaWAN and 4G/5G technologies.
 - The end-to-end security is ensured thanks to the LoRaWAN integrity and confidentiality up to the network and application servers, respectively.

LoRaWAN-EPC Secure Integration Proposal

We propose to leverage the USIM cards to improve the security of the LoRaWAN communications:

- In ABP, the LoRaWAN device must store the 128-bit session keys NwkSKey and AppSKey.
- In OTAA, the device must store the AppKey, which is used to derive the aforementioned session keys.
- The security in both cases can be compromised → The usage of a cryptographic chip is highly beneficial.
- So, to leverage existing USIM cards, we propose to use the 128-bit ciphering and integrity keys CK and IK as the LoRaWAN session keys.

- These keys are derived from the RAND value (sent by the network), the secret key K (stored in the USIM), and an operator-dependent value OP, using the f3 and f4 functions.
- In LoRaWAN devices using USIM cards as cryptographic chips, the input RAND value may be computed as a concatenation of DevNonce, AppNonce, and other parameters (e.g., DevEUI and NetId).

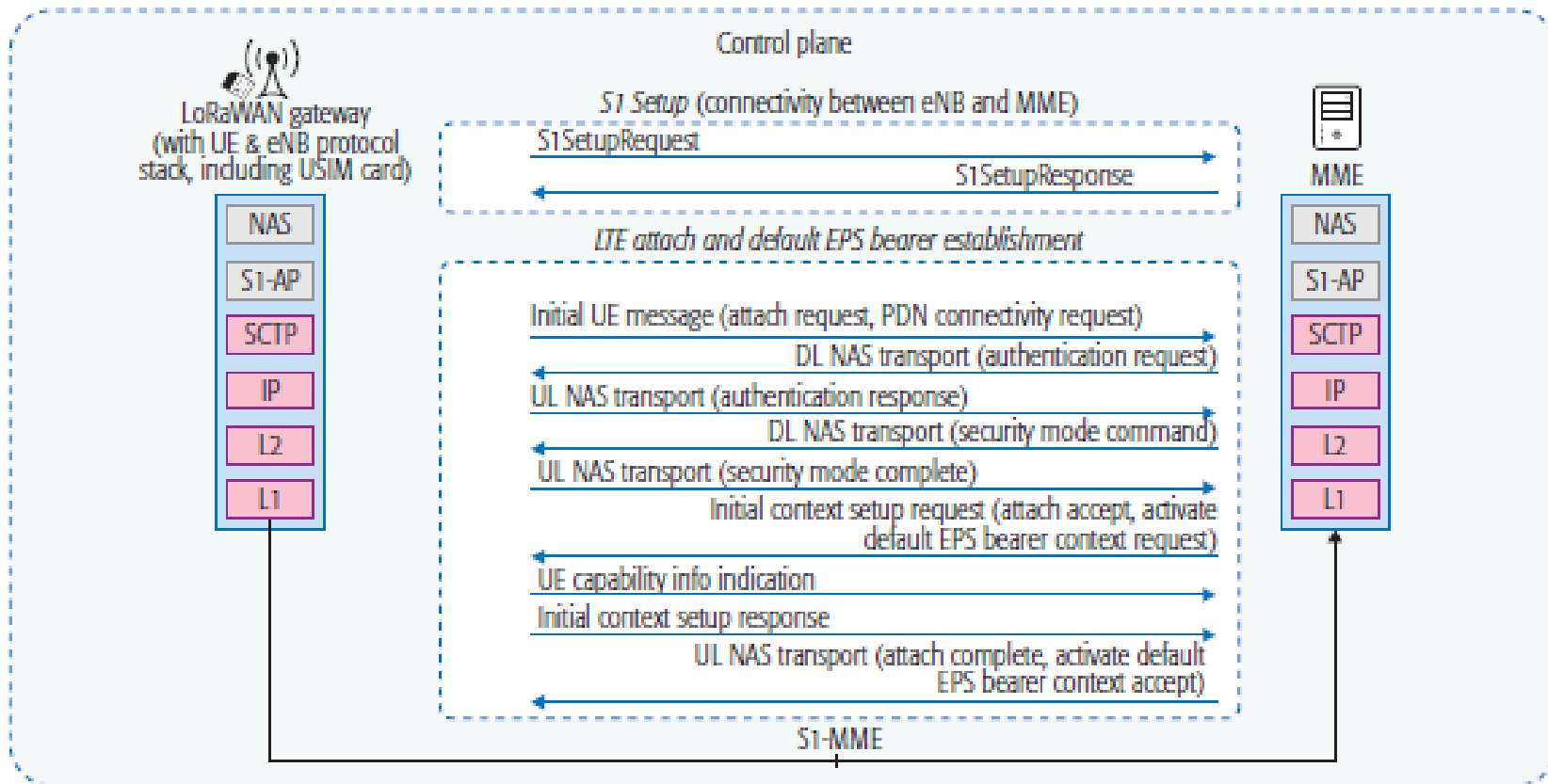

Acknowledgment

ACKNOWLEDGMENT

- European Union through the ERANETMED (Euromediterranean Cooperation through ERANET joint activities and beyond) project ERANETMED3-227 SMARTWATIR,
- “Ministerio de Economía, Industria y Competitividad”, through the “Convocatoria 2016 - Proyectos I+D+I - Programa Estatal De Investigación, Desarrollo e Innovación Orientada a los retos de la sociedad” (Project TEC2016-76795-C6-4-R),
- “Ministerio de Ciencia, Innovación y Universidades” through the “Ayudas para la adquisición de equipamiento científico-técnico, Subprograma estatal de infraestructuras de investigación y equipamiento científico-técnico (plan Estatal I+D+i 2017-2020)” (project EQC2018-004988-P)

“There are no secrets to success. It is the result of preparation, hard work, and learning from failure.”



Colin Powell

Publications:

<https://scholar.google.es/citations?user=emSqcUQAAAAJ>

<https://orcid.org/0000-0001-9556-9088>

<https://www.scopus.com/authid/detail.uri?authorId=35189596800>

[https://www.researchgate.net/profile/Sandra Sendra](https://www.researchgate.net/profile/Sandra_Sendra)



Sandra Sendra Compte

ssendra@ugr.es