



Towards Software Driven /Enabled Networks

**Trends and Research Directions in
Future Networked and Service
Systems**

**NexComm, 24th April 2013 Venice
Keynote**

Alex Galis
University College London
a.galis@ucl.ac.uk
www.ee.ucl.ac.uk/~agalis



Contents

- 1. Current Internet**
- 2. Towards a *Network Softwarization***
- 3. Future Networks – *Design Goals & Software Enabled Features***
- 4. Towards a *Network Programmability***
- 5. Towards a *Unified Management* – FP7 Univerself project**
- 6. Concluding Remarks**

ARPAnet Plan – late 1960s

Rough sketch by Larry Roberts

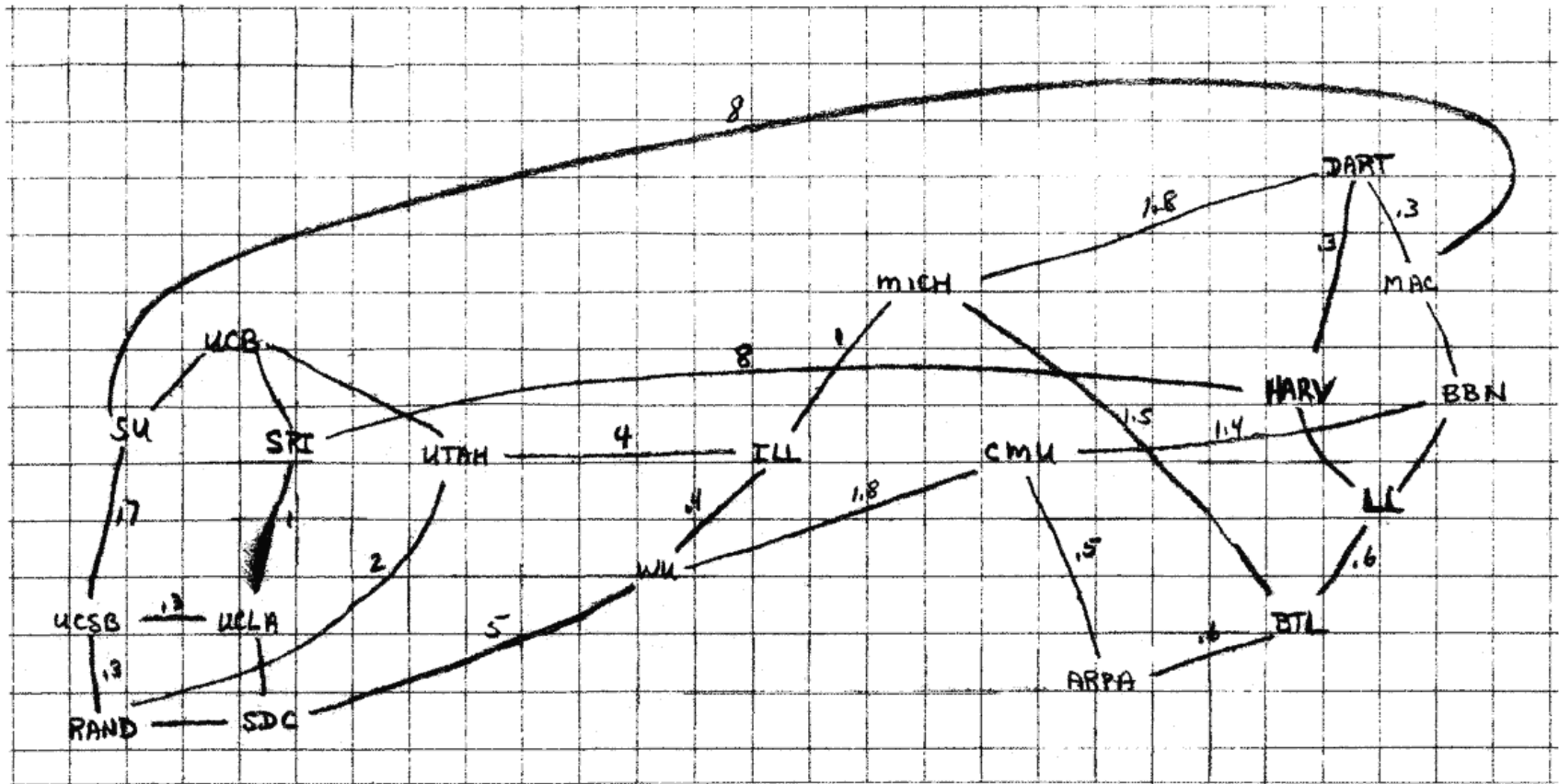

Internet 1973-74



Abb. 4 ARPANET network, topological map. Stand Juni 1974.

UCL connected in July 1973 to ARPAnet

Current Internet

- The Internet as a **connectivity platform** plays a central and vital role in our society
 - Work and business, education, entertainment, social life, ...
- Victim of its own success, suffering from **ossification**
 - Innovation meets natural resistance (e.g. no IPv6, no mobile IP, no inter-domain DiffServ, no inter-domain multicast, etc.)
- Services such as P2P, IPTV, Cloud services, emerging services, pose new requirements on the underlying network architecture. **OPEX costs are up to 90%**
- Big growth in terms of the number of inter-connected devices but **slow growth in new services**

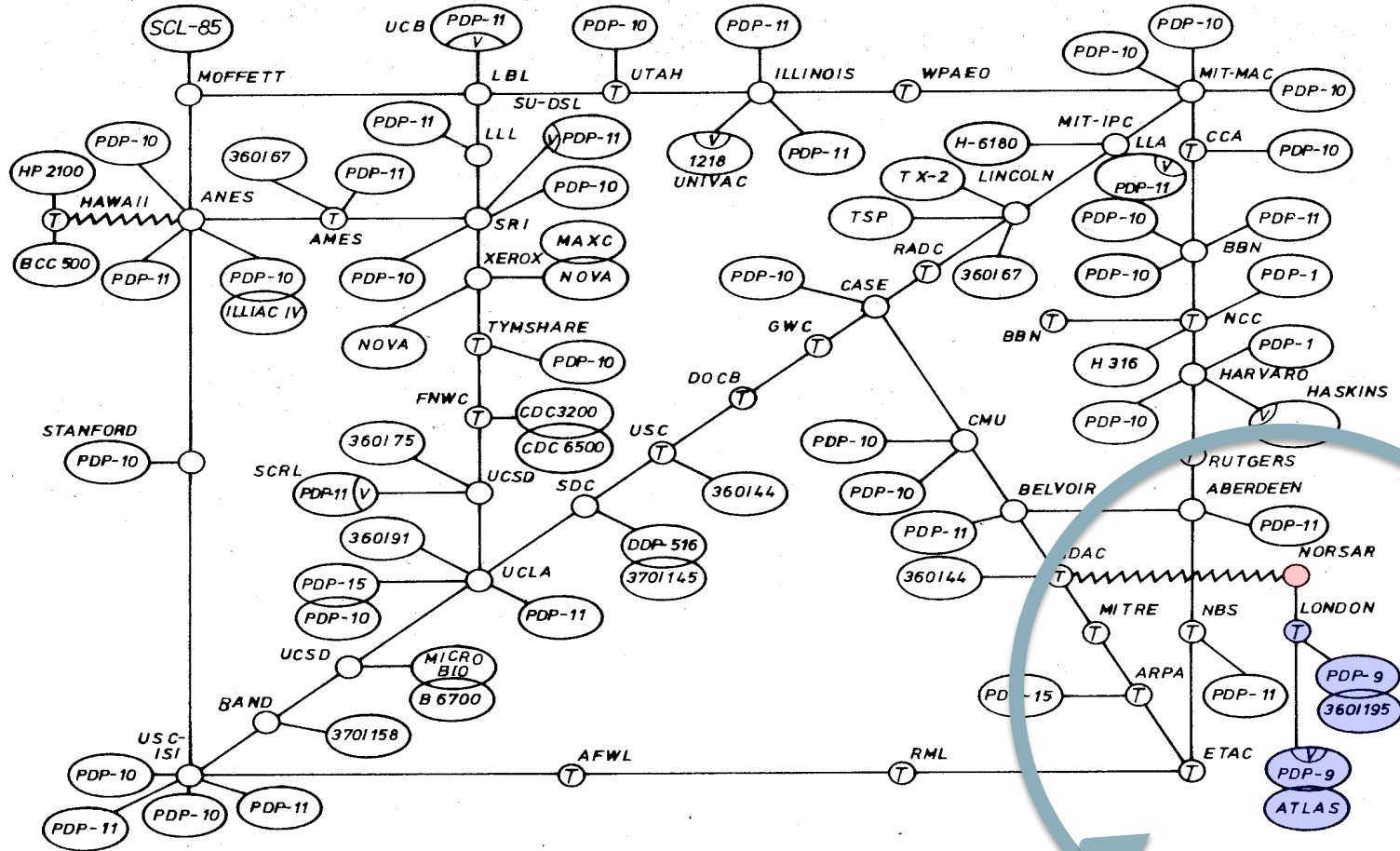
Key Changes in Internet - History

- Changes were possible when the Internet was still an academic research network (i.e. until 1993 when the WWW turned it to a commercial)
- Inter-network that underpins the “information society”
- Key changes in that period were the following: 1982 DNS, 1983 TCP/IP instead of NCP, 1987 TCP congestion control, 1991 BGP policy routing, 1991 SNMP
- No significant changes since then apart from MPLS which has been deployed in addition to plain IP
- Research efforts towards the Future Internet: ***evolutionary & clean-slate approaches, autonomic management, Internet softwarization***

Internet Hour-glass Model

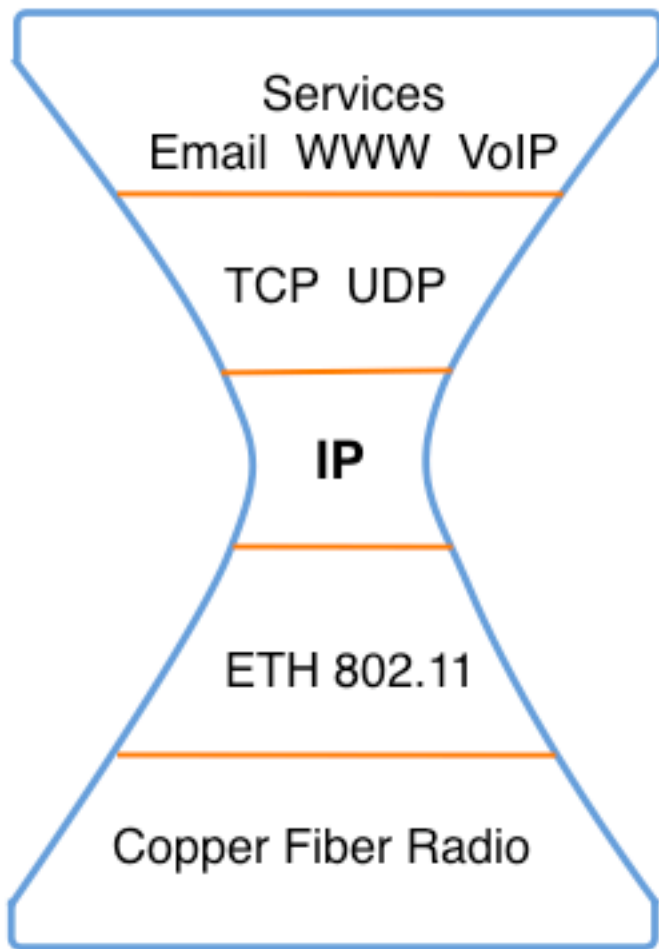

Data Plane

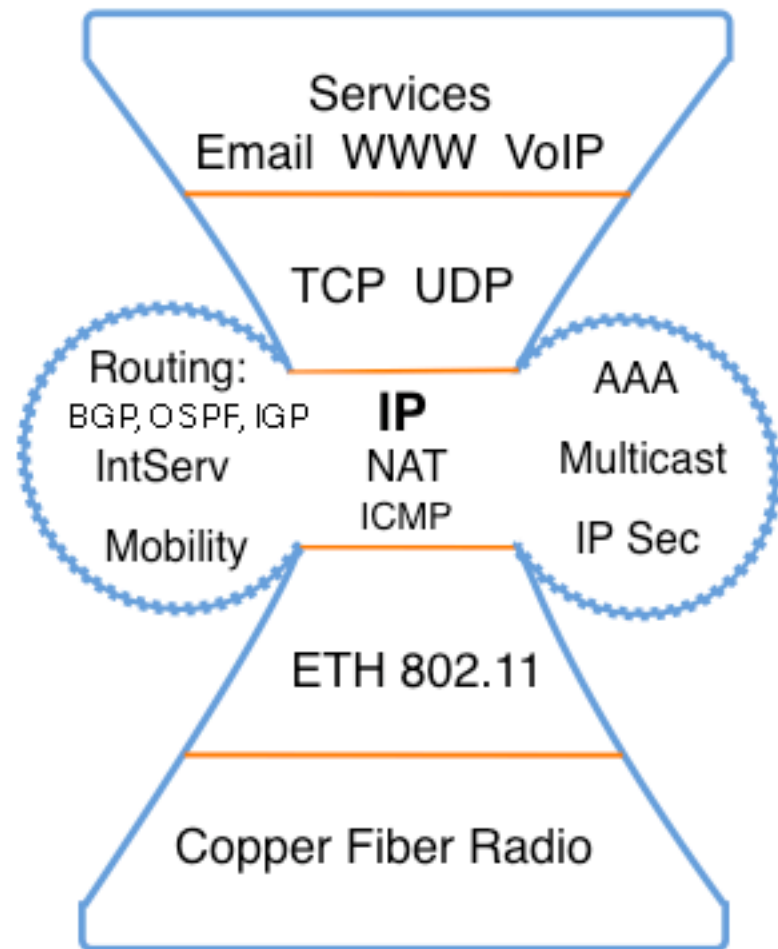

Control Plane

Some current systemic limits

- Networks are becoming both a connectivity and service execution environment
 - **Work towards a service and management aware connectivity infrastructure**

- Computation, storage and connectivity Virtualised separately (but not in an integrated way)
 - **Work towards a flexible and cost effective integrated virtual infrastructure with elastic usage and sharing resources**

- Silos and disparate systems with limited extensibilities which created a segmentation of networking & computation
 - **Programmability: dynamic and autonomic activation of network and service functions**

- Need for Software driven / enabled features:
 - - **Programmability and Elasticity**
 - **Integrated Virtualisation of Connectivity Storage and Processing Resources**
 - **In-Network Management**
 - **Service awareness**
 - **Energy awareness**
 - **Content awareness**
 - **Knowledge awareness**
 - **Economic awareness**
 - **Extensibility with new features**
 -

Drivers for Change

- **Disappearance of the 'End-host only' concept** (i.e. edge networks; new nodes : sensors, mobile devices;)
- **Lack of in-system management** (i.e. information, decision, implementation – closed control loops for realizing management requirements)
- **Trustworthy User / Network / Service** (i.e. end-host protocols can and are altered → many security issues)
- **Best effort service delivery**
- **No explicit media & content handling**
- **Size & Costs:**
 - $N \times 10^9$ connectivity points - status: reaching maturity and maybe some limits
 - $N \times 10^5$ services /applications - status: fast growing
 - $N \times 10^3$ Exabyte's content - status: fast growing
 - Cost structure: 80% (→90%) of lifecycle costs are operational and management costs - status: reaching crisis level
- **Ossification:** reaching crisis level
 - A lot of missing and interrelated features; missing enablers for integration and orchestration of Nets, Services, Content, Storage
 - Substantial barriers to innovation with novel services, networking systems, architecture and technologies

How to Change

Approaches:

- Parallel Internets; Progressive changes; “Clean” slate and evolutionary
- Network of networks → system of coordinated service networks
- Virtualization of resources (Networks, Services, Content, Storage)
- Programmability
- Increased self-manageability as the means of controlling the complexity and the lifecycle costs
- Softwarization and Programmability

Contents

1. Current Internet
2. Towards a *Network Softwarization*
3. Future Networks – *Design Goals & Software Enabled Features*
4. Towards a *Network Programmability*
5. Towards a *Unified Management* – FP7 Univerself project
6. Concluding Remarks

Future Internet – some differences

Current Internet Infrastructure = Network of Interconnected uncoordinated connectivity infrastructures, connecting people, devices and computers.

Future Internet Infrastructure = A Softwarization of the Network

- Service-aware connectivity infrastructure connecting and orchestrating the future Internet of people, content, clouds, devices, computers and things
- Unlike the original Internet set of standards, which merely focus on technical connectivity, routing, and naming, the scope of the Future Internet recommendations, standards, and guidelines should encompass all levels of interfaces for Services as well as technical virtual and physical resources.
- They should further support the complete lifecycle of applications and services that are primarily constructed by recombining existing elements in new and creative ways.
- New architecture becomes necessary when balance among important issues varies (e.g. Life system costs Vs. Node costs; upsurge of new services and new end-user devices)

Research & Standardization Initiatives

Research Initiatives:

1. Korea - Future Internet Forum - <http://fif.kr/>
2. Asia Future Internet - <http://www.asiafi.net/>
3. Japan - AKARI Future Internet - <http://akariproject.nict.go.jp/eng/conceptdesign.htm>
4. USA - Global Environment for Network Innovations (GENI) - <http://www.geni.net>
5. European Union - Future Internet Assembly (FIA) www.future-internet.eu

Future Networks Standardization in

1. ITU-T Future Networks (FN)
2. ETSI Network Virtualization Functions (NVF)
3. IETF Software Defined Networks (SDN), FORCES
4. ONF Open Network Foundation

Contents

1. Current Internet
2. Towards a *Network Softwarization*
3. Future Networks – *Design Goals & Software Enabled Features*
4. Towards a *Network Programmability*
5. Towards a *Unified Management* – FP7 Univerself project
6. Concluding Remarks



❑ ITU-T FG FN - Focus Group Future Networks

**Objective: document results that would enable deve
Recommendations for future networks**

www.itu.int/en/ITU-T/focusgroups/fn/Pages/Default.aspx

Results:

❑ **ITU-T Recommendation Y.3001 “ Future Networks- Objectives and Design Goals”**

❑ **FNs Vision Document + 3 Supporting Technologies**

With contribution - concepts & references from FIA MANA & FP7 projects: Autol, RESERVOIR, 4WARD, Univerself

Chairman:

Takashi Egawa (NEC, Japan)

Morita Naotaka (NTT, Japan)

Vice-Chairman:

Hyoung Jun Kim (ETRI, Korea)

Vice-Chairman:

Alex Galis (University College London, UK)

Reference: “Towards Future Networks – a viewpoint from ITU-T”- Matsubara, D., Egawa, T., Nishinaga, N., Kafle, V. P., Shin, M. K., Galis, A., IEEE Communication Magazine, Vol. 51, No.3, March 2013, pp 112-118

Future Networks : Objectives Vs. Design Goals



Y.3001 -
FN objectives & design goals

Y.3011 -
FN virtualisation

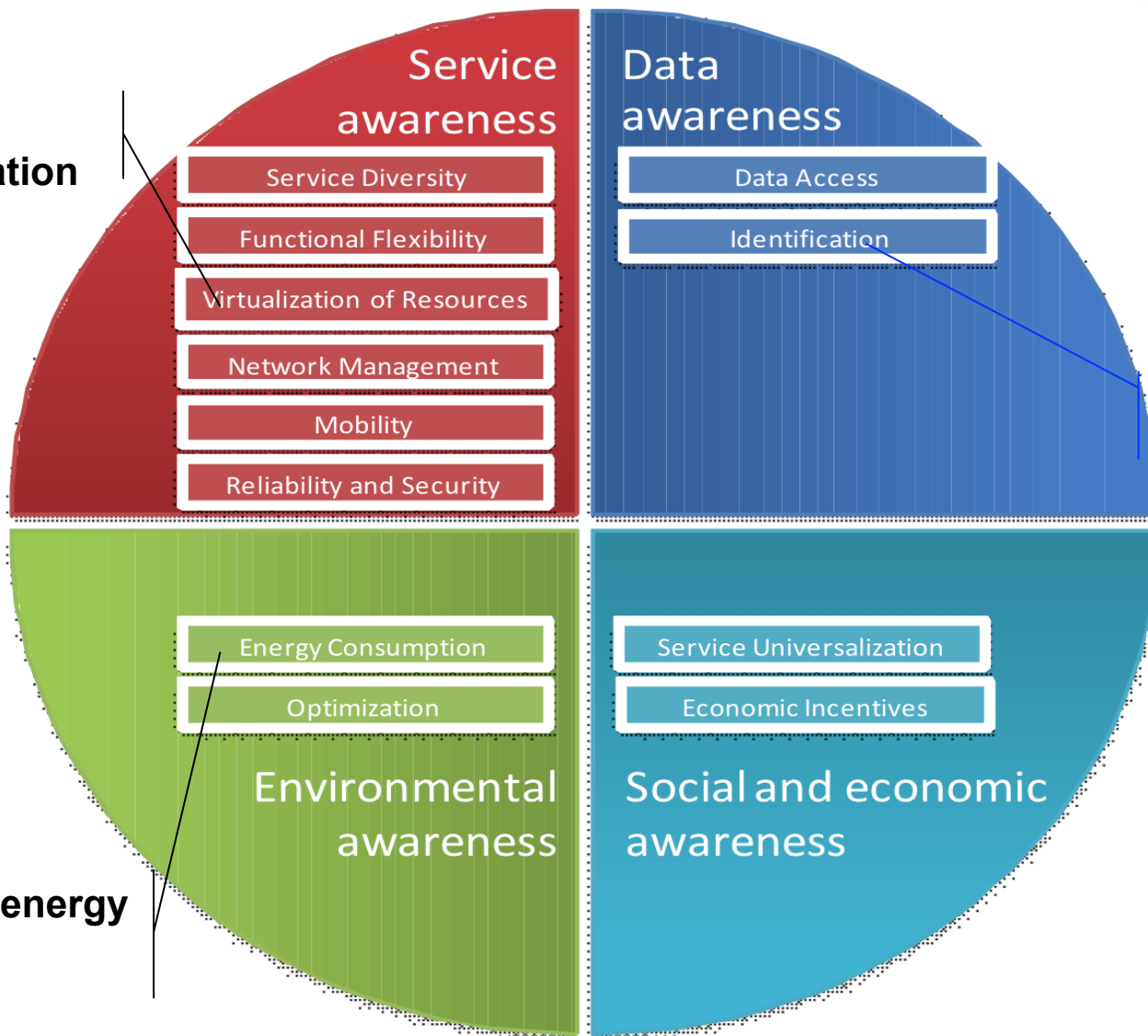

Y.3031 - ID configuration

Y.3021 - FN energy

Future Networks - Four Objectives

- **Environment awareness**
 - FNs should be environmental friendly.
- **Service awareness**
 - FNs should provide services that are customized with the appropriate functions to meet the needs of applications and users.
- **Data awareness**
 - FNs should have architecture that is optimized to handling enormous amount of data in a distributed environment.
- **Social-economic awareness**
 - FNs should have social-economic incentives to reduce barriers to entry for the various participants of telecommunication sector.

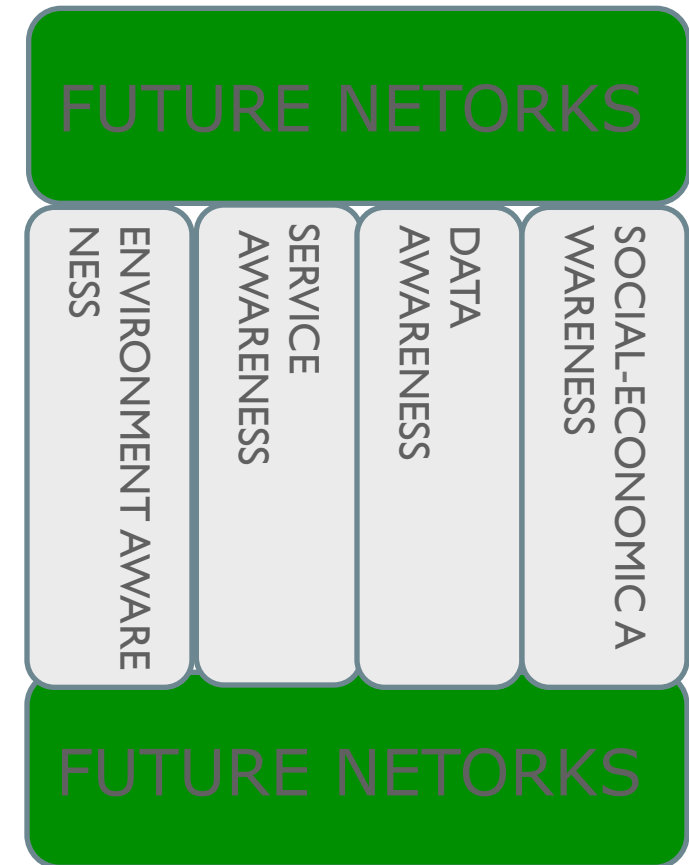

Future Networks - 12 Design Goals



- ① **(Service Diversity)** FNs should accommodate a wide traffic and support diversified services
- ② **(Functional Flexibility)** FNs should have flexibility to support and sustain new services derived from future user demands
- ③ **(Virtualization of resources)** FNs should support virtualization so that a single resource can be used concurrently by multiple virtual resources.
- ④ **(Data Access)** FNs should support isolation and abstraction FNs should have mechanisms for retrieving data in a timely manner regardless of its location.
- ⑤ **(Energy Consumption)** FNs should have device, system, and network level technologies to improve power efficiency and to satisfy customer's requests with minimum traffic
- ⑥ **(Service Universalization)** FNs should facilitate and accelerate provision of convergent facilities in differing areas such as towns or the countryside, developed or developing countries

FNs - 12 Design Goals (Cont.)



- ⑦ (Economic Incentives) FNs should be designed to provide sustainable competition environment to various participants in ecosystem of ICT by providing proper economic incentives**
- ⑧ (Network Management) FNs should be able to operate, maintain and provision efficiently the increasing number of services and entities.**
- ⑨ (Mobility) FNs should be designed and implemented to provide mobility that facilitates high levels of reliability, availability and quality of service in an environment where a huge number of nodes can dynamically move across the heterogeneous networks.**
- ⑩ (Optimization) FNs should provide sufficient performance by optimizing capacity of network equipments based on service requirement and user demand.**
- 11 (Identification) FNs should provide a new identification structure that can effectively support mobility and data access in a scalable manner.**
- 12 (Reliability and Security) FNs should support extremely high-reliability services**

Future Networks : Objectives Vs. Design Goals²⁰

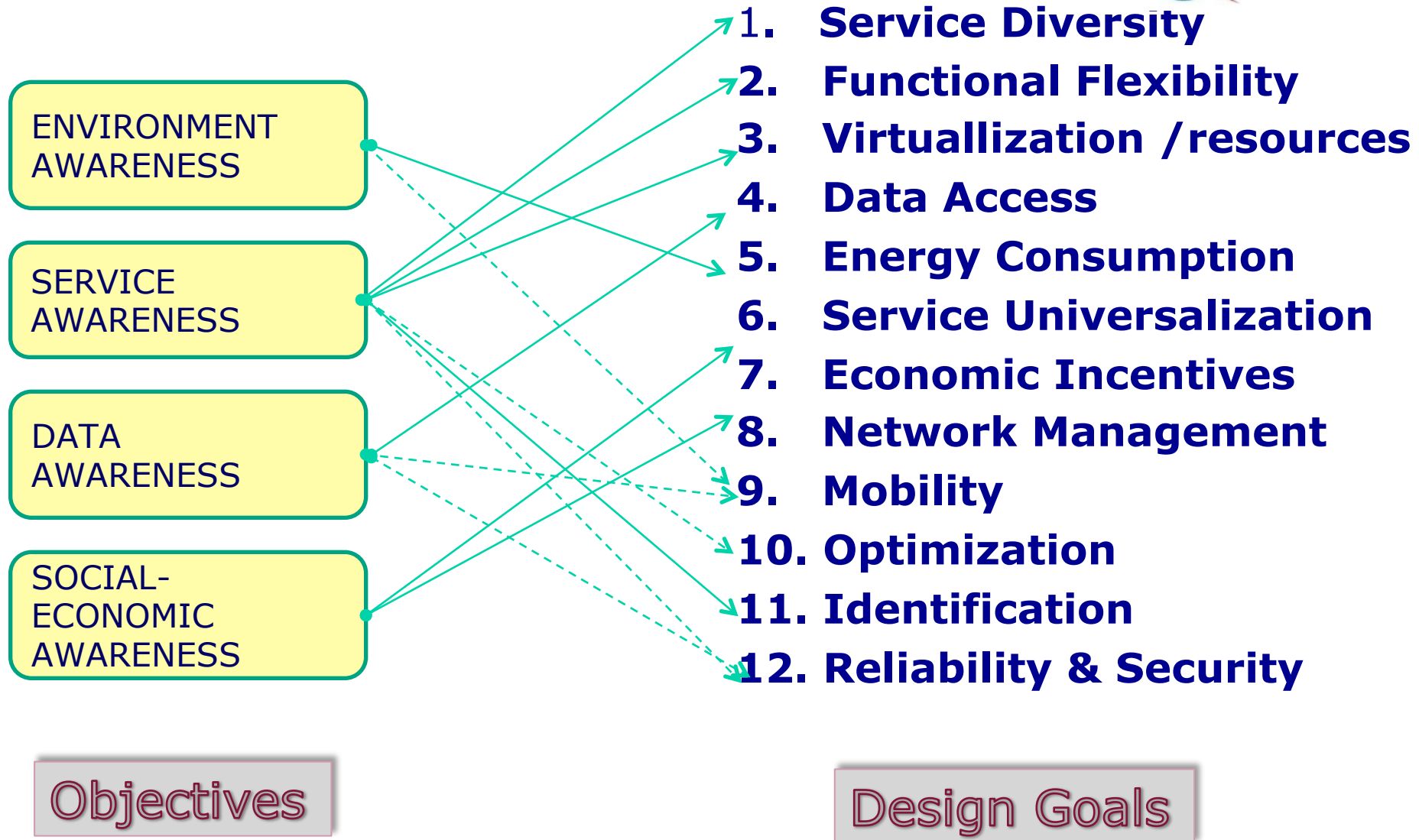

Technologies - achieving the design goals



- **Virtualization of Resources (Network Virtualization)**
 - Enables creation of logically isolated network partitions over shared physical network infrastructures so that multiple heterogeneous virtual networks can simultaneously coexist over the shared infrastructures; it allows the aggregation of multiple resources and makes the aggregated resources appear as a single resource
- **Data/Content-oriented Networking (Data Access)**
- **Energy-saving of Networks (Energy Consumption)**
 - Forward traffic with less power
 - Control device/system operation for traffic dynamics
 - Satisfy customer requests with minimum traffic
- **In-system Network Management (Network Management)**
- **Distributed Mobile Networking (Mobility)**
- **Network Optimization (Optimization)**
 - Device / System / Network level optimization (Path optimization, Network topology optimization, Accommodation point optimization)

ITU-T Future Networks

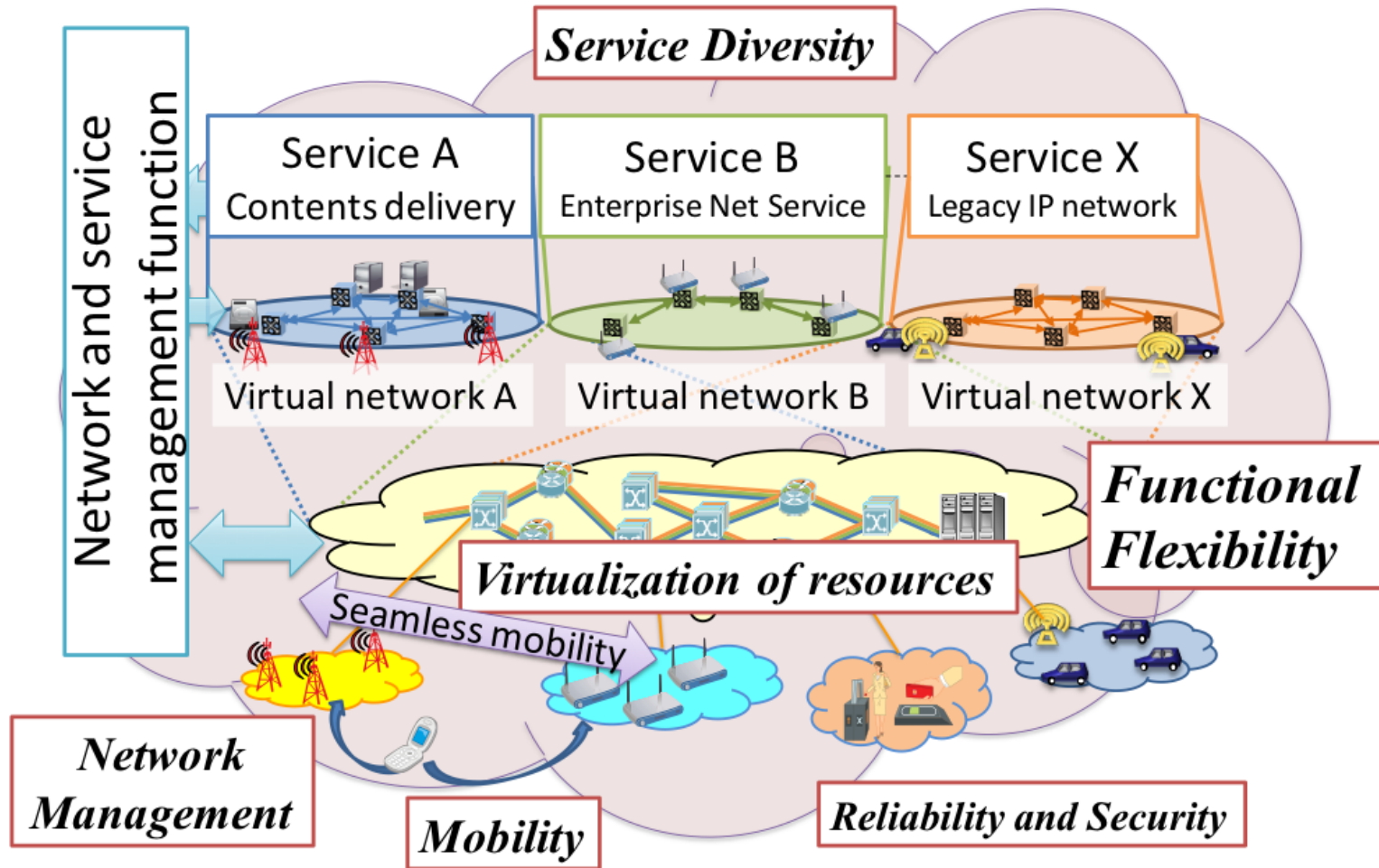

Future Network Virtualization

Network virtualization is required to be capable of providing multiple virtual infrastructures those are isolated each other.

The virtualized infrastructures may be created over the single physical infrastructure

Each virtual network is isolated each other and is programmable to satisfy the user's demand on the functionality and amount

User's demand is conveyed to Logically Isolated Network Partition (LINP) manager which is required to coordinate infrastructures so that appropriate network resource is provided to the user

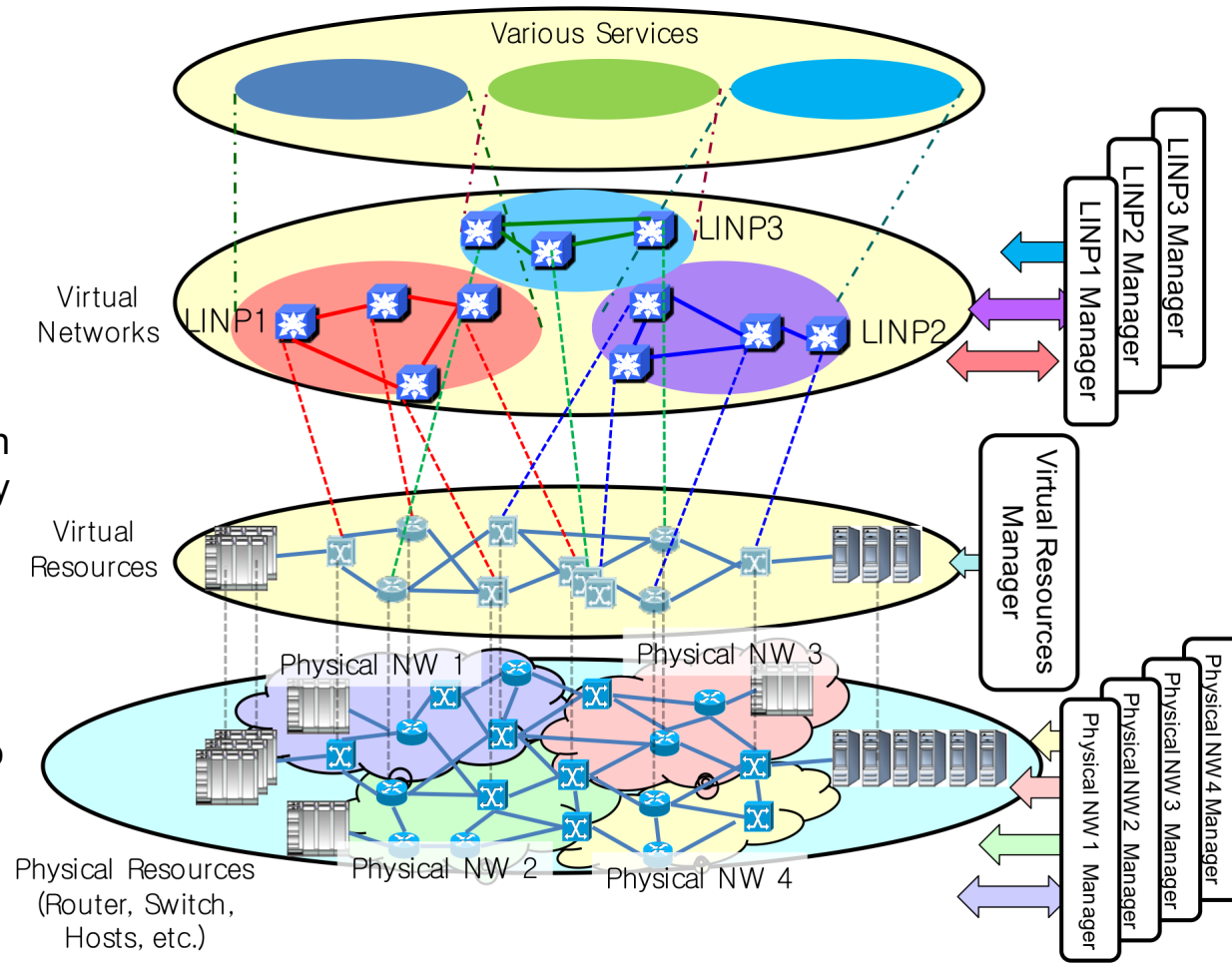

ITU-T Future Networks



ITU-T Future networks activity timeline (Roadmap)

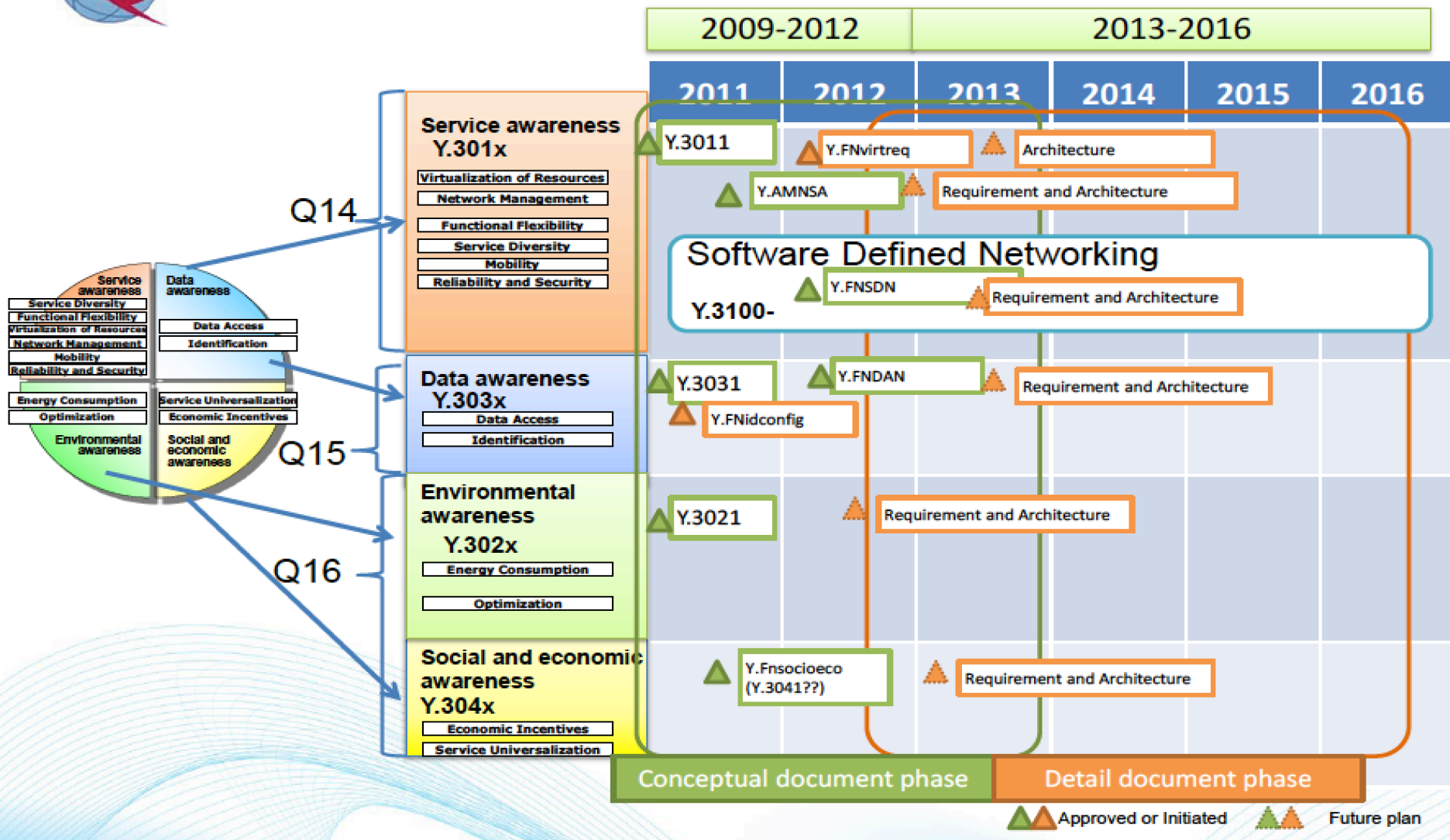

Contents

1. Current Internet
2. Towards a *Network Softwarization*
3. Research & Standardization Initiatives
4. Future Networks – Design Goals / Software Enabled Features
5. Towards a *Network Programmability*
6. Towards a *Unified Management* – FP7 Univerself project
7. Concluding Remarks

SDN Evolution - Conceptual Networked Systems

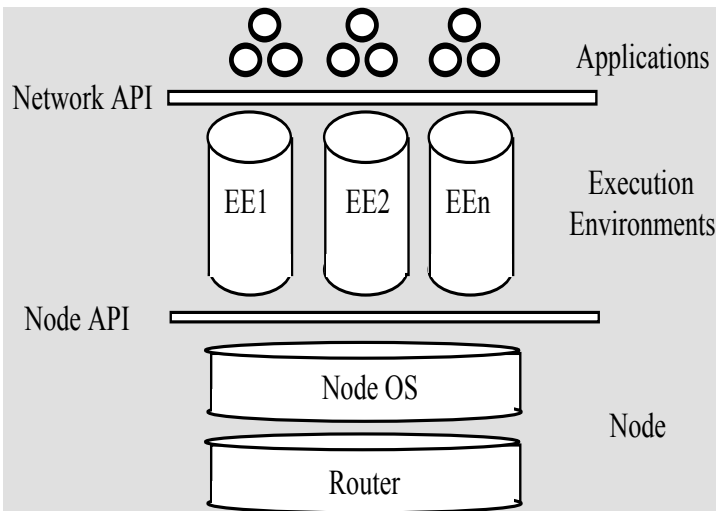

SDNs Architecture

Connectivity & Computation Infrastructure

Status in the early **2000+**

(active & programmable networks)

LOOK INSIDE!

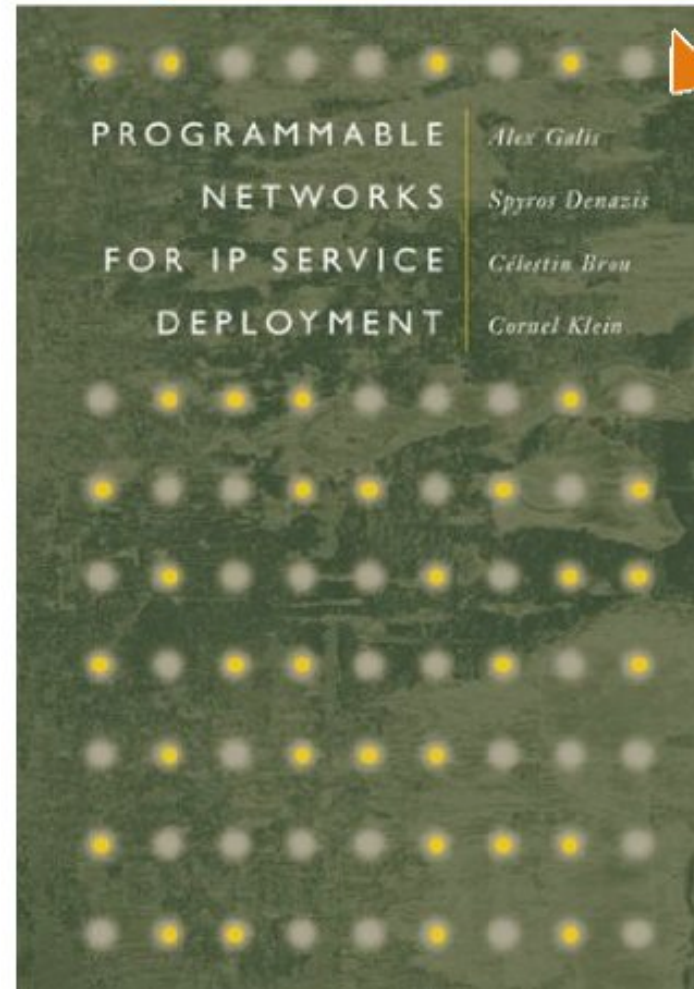

SDN Evolution - Conceptual Networked Systems

SDNs Architecture *Connectivity Only Infrastructure* *Status in the 2010+*

(ONF – Open Networking Foundation)

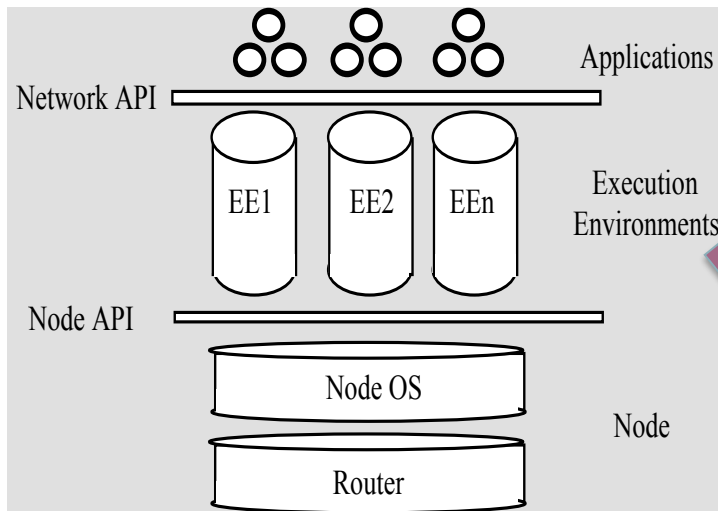
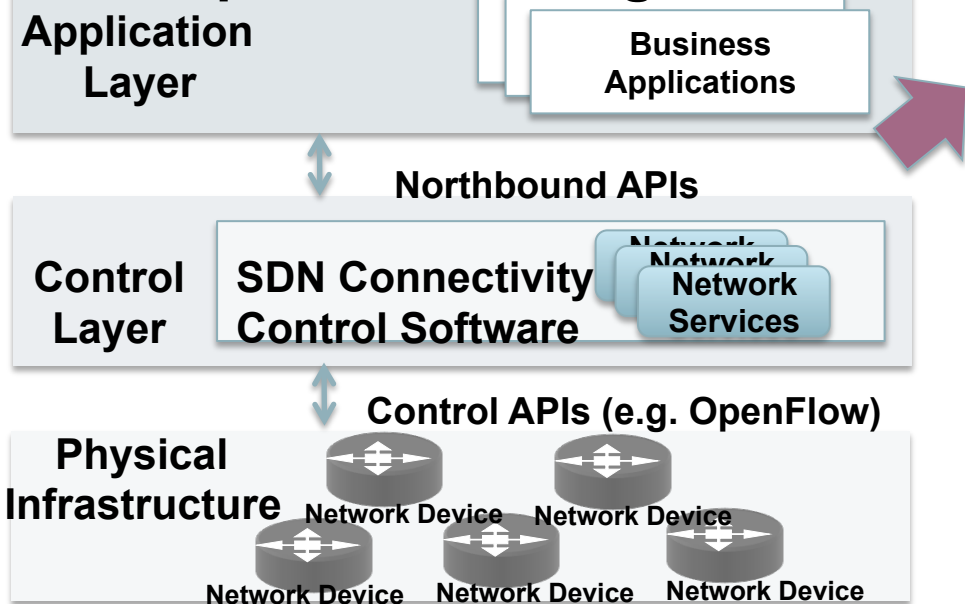

SDNs Architecture

Connectivity & Computation Infrastructure

Status in the early 2000+

(active & programmable networks)

Revised SDN Architecture → Service-aware Networked Systems

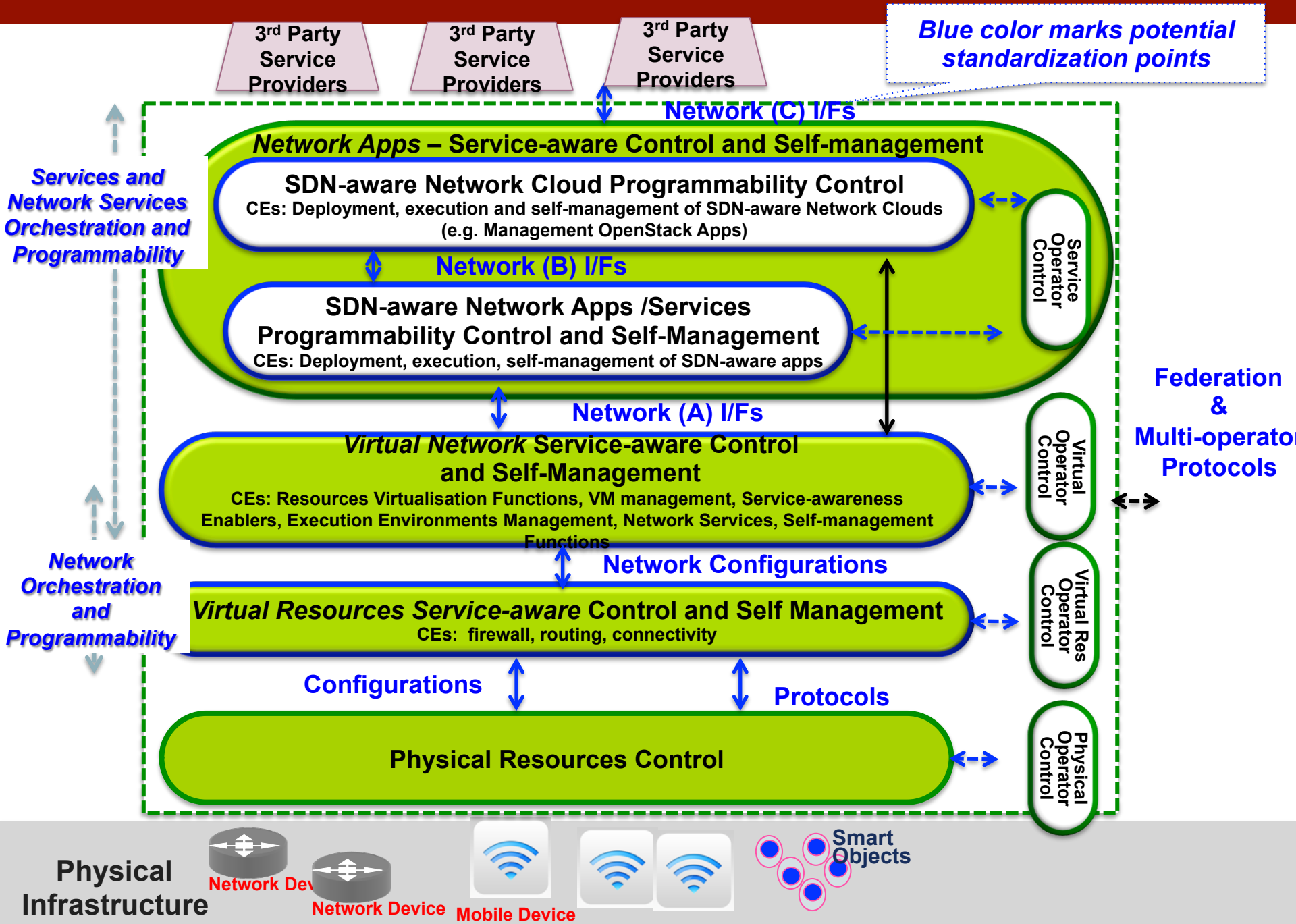

Revised SDN Architecture → Service-aware Networked Systems

In-bound control programs
with global view of the network

In-bound cognitive management

Extensible Software Driven
Features
Open APIs

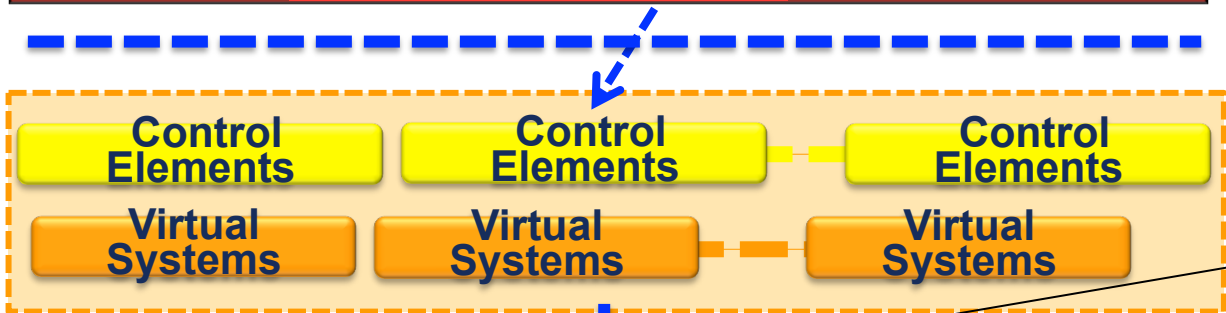
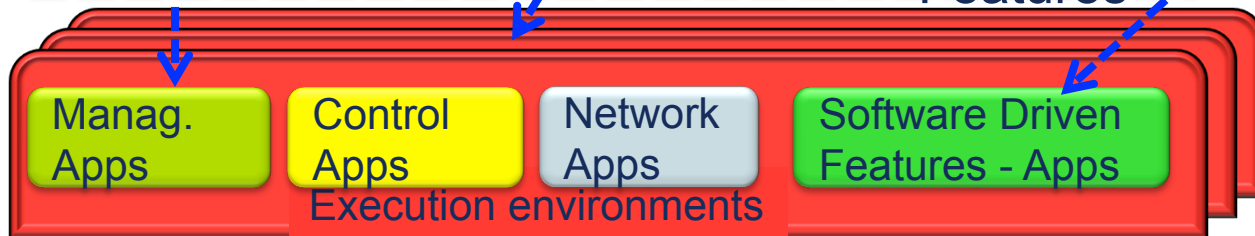

Open APIs

Open Interfaces to forwarding hardware

Routing, local management, access control, VPNs, resource-facing services ...

user-facing applications & services ...

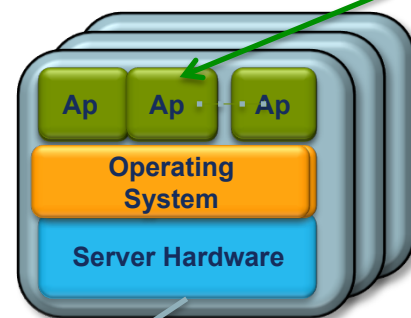
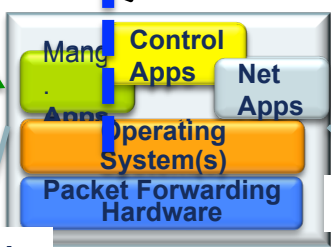

Smart Objects

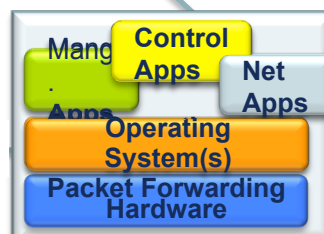
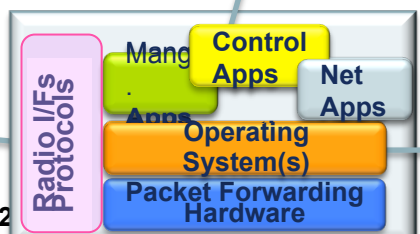

Protocols

Contents

- 1. Current Internet**
- 2. Towards a *Network Softwarization***
- 3. Research & Standardization Initiatives**
- 4. Future Networks – Design Goals / Software Enabled Features**
- 5. Towards a *Network Programmability***
- 6. Towards a *Unified Management* – FP7 Univerself project**
- 7. Concluding Remarks**

Unified (Self)Management Filling in the Research

UniverSelf FP7 Project: <http://www.univerself-project.eu>



Federating

- Self-* has been a major focus, time to consolidate achievements
- Both systems and services need to be managed
- Services span multiple technological domains (wireline and wireless)

Impactful

- Driven by scenarios identified by service and network providers, solving live-networks manageability bottlenecks
- Trust, certification/labeling and validation to foster deployments
- Standards for industry wide adoption

"Cleaned state not clean... state"

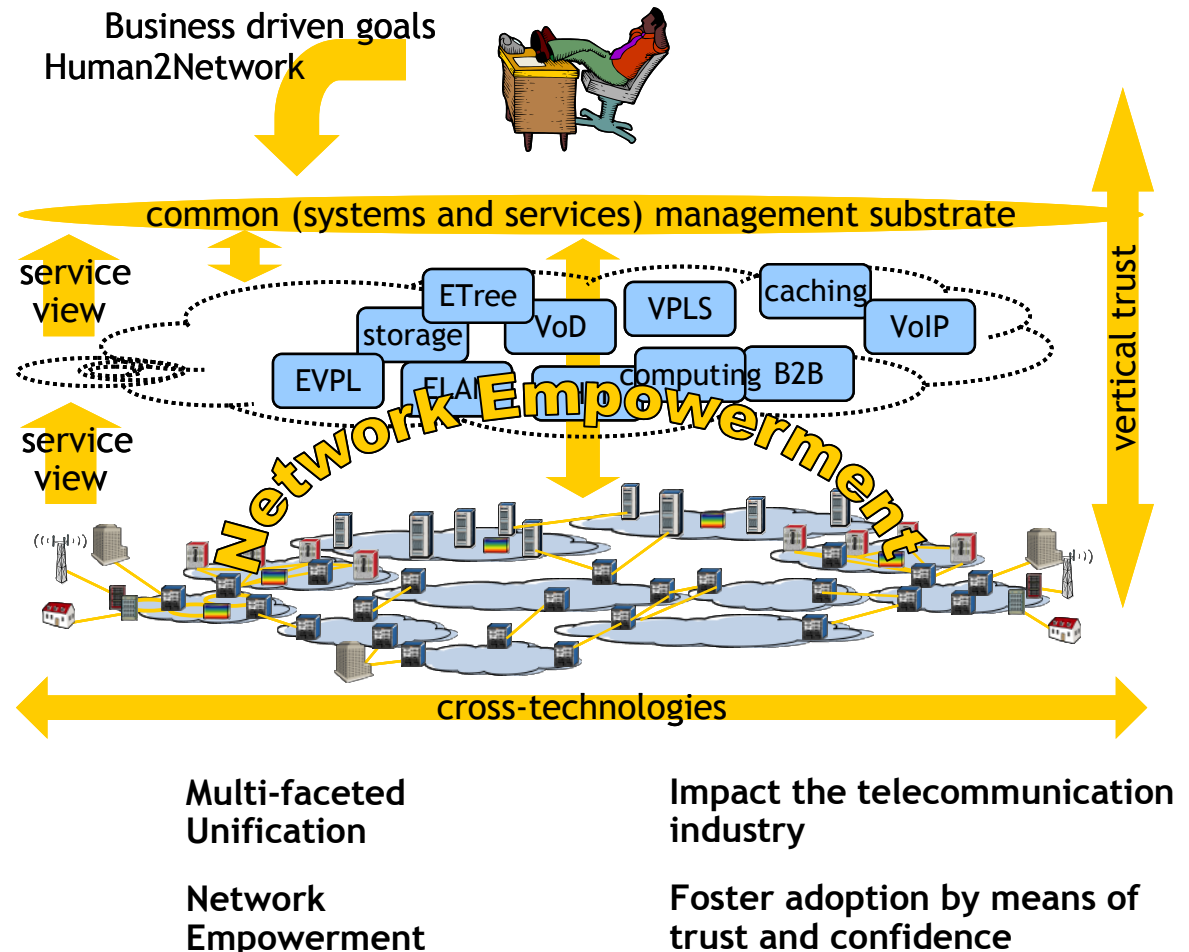

Unified (Self)Management Filling in the Research

UniverSelf FP7 Project: <http://www.univerself-project.eu>

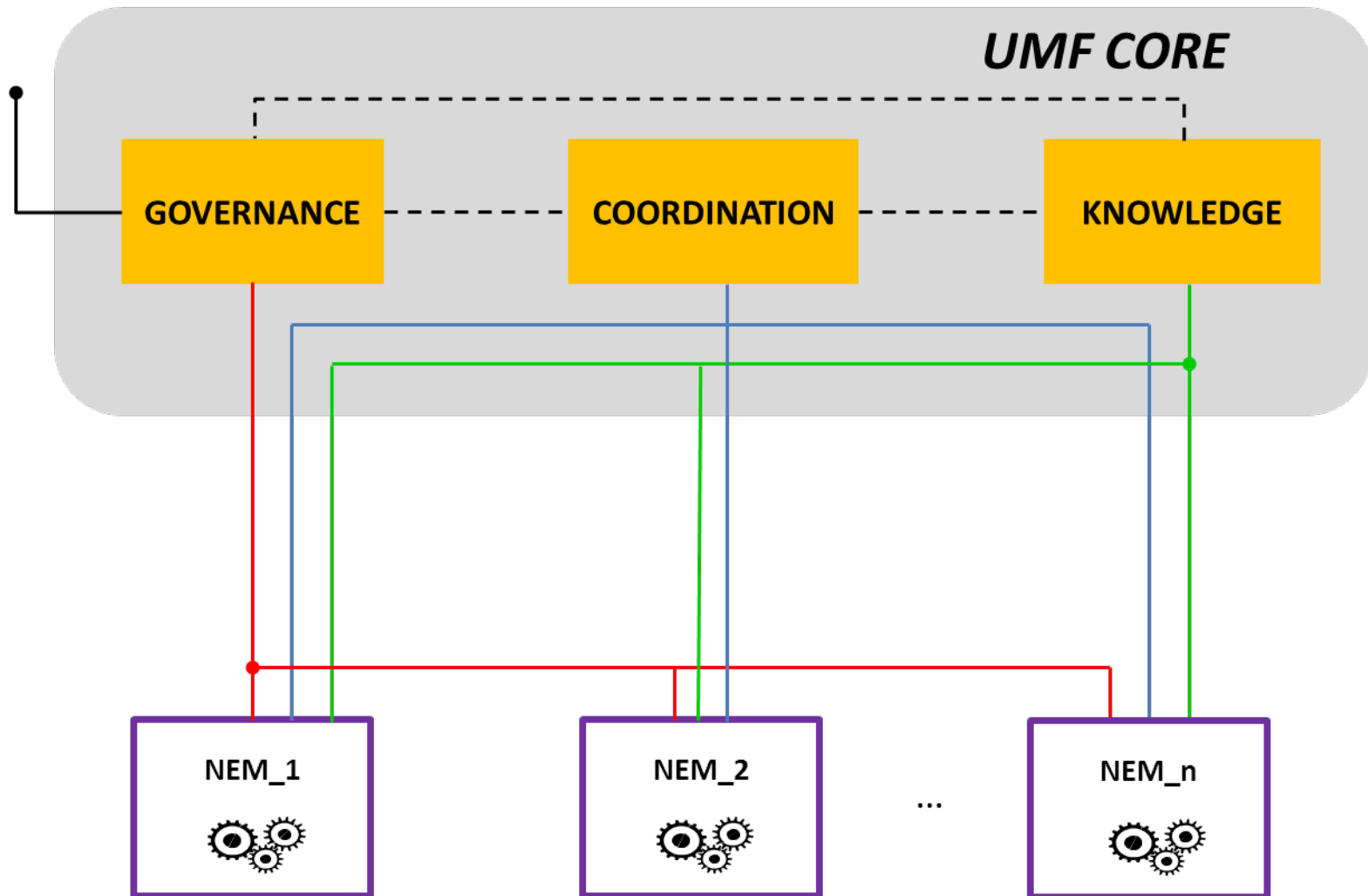

UCL SEN Management TestBed

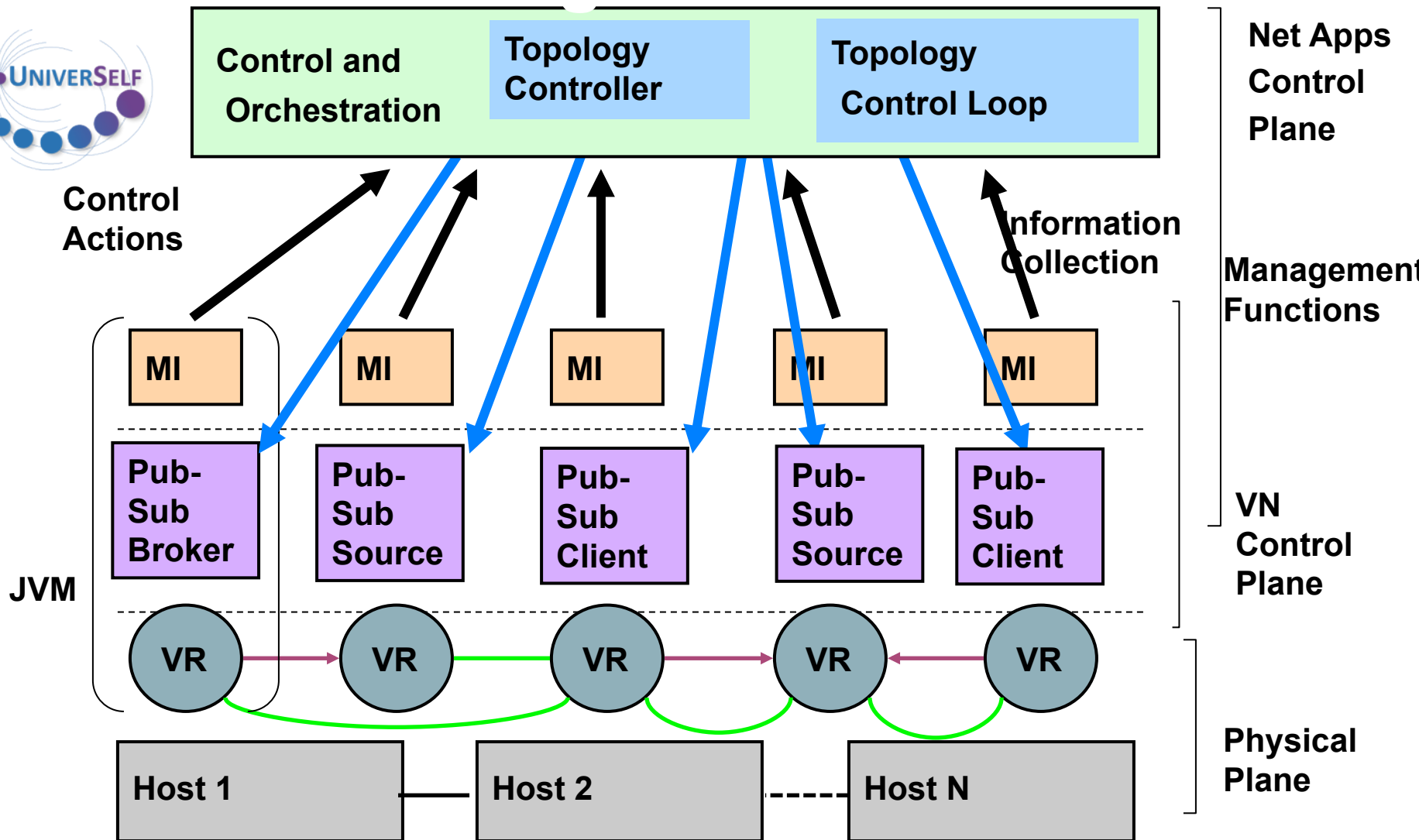

Key:

PS - Publication /Subscription Sources/Clients VR – Virtual Router MI – Monitoring Instrumentation (probes, control points data sources, filtering, data structures)

Contents

- 1. Current Internet**
- 2. Towards a Network Softwarization**
- 3. Research & Standardization Initiatives**
- 4. Future Networks – Design Goals / Software Enabled Features**
- 5. Towards a Network Programmability**
- 6. Unified Management – FP7 Univerself project**
- 7. Concluding Remarks**

Concluding Remarks

Current Internet = Network of Interconnected uncoordinated networks – “infrastructure where intelligence is located at the edges”

- **Simple network layer ;Services are realised at the end-hosts**
- **KISS Principle : “Keep it Simple, Stupid” (i.e. today optimisation is tomorrow’s bottleneck) source: D. Isenberg**

Software Enabled Networks - Infrastructure where the intelligence is embedded and enabled

Substitute KISS principle with ***KII principle : “Keep it intelligent”*** (i.e. today fundamental is tomorrow’s secondary) source A. Galis

Unified (Self)Management, Programmability and Software Features would represent nearly 100% of the Future Software Enabled Networks functionality