

# Panel session Open Internet and Net Neutrality

## **Moderator:**

Alessandro Bogliolo, University of Urbino, Italy

## **Guest Panelists:**

Eugen Borcoci, University Politehnica Bucuresti, Romania  
Mark Yampolskiy, German Research Network (DFN), Germany  
Alessandro Bogliolo, University of Urbino, Italy  
Dirceu Cavendish, Kyushu Institute of Technology, USA/Japan

# Program

- *Network neutrality versus content oriented networking*  
**Eugen Borcoci**  
University Politehnica Bucuresti, Romania
- *Network neutrality at risk. Staying at the edge of the abyss?*  
**Mark Yampolskiy**  
German Research Network (DFN), Germany
- *Who pays for traffic in a neutral Internet?*  
**Alessandro Bogliolo**  
University of Urbino, Italy
- *A Balanced View on Network Neutrality*  
**Dirceu Cavendish**  
Kyushu Institute of Technology, USA/Japan

# *Network neutrality versus content oriented networking*

**Eugen Borcoci**

University Politehnica Bucuresti, Romania

Eugen's teaching and research activities are oriented to specific domains of Computer and telecommunication networking: **architectures** (current and Future Internet), **protocols**, **multimedia/QoS**, **management**, etc. He published over 150 scientific papers, studies, etc., and conducted as team leader many research national and international projects (FP5, 6, 7).

# *Network neutrality at risk. Staying at the edge of the abyss?*

**Mark Yampolskiy**

German Research Network (DFN), Germany

Mark has studied applied mathematics in Moscow and computer science in Munich, with a Ph.D. in computer science in the area of computer networks and network management (focus on **QoS assurance** in multi-domain network connections). Now working in Géant research collaboration and involved in numerous research activities tackling **network management issues in multi-domain environments**. Among other, he is in charge for design and development of monitoring tool for multi-domain backbone connections, so called Géant E2E Links.

# *Who pays for traffic in a neutral network?*

**Alessandro Bogliolo**

University of Urbino, Italy

Alessandro received Ph.D. degree in Electrical Engineering and Computer Science from the University of Bologna (1999) and worked for the University of Bologna, Stanford University, and University of Ferrara. In 2002 he joined the University of Urbino, Italy, where he's currently responsible for the Information Science and Technology Division of the Department of Base Sciences and Fundamentals. In 2010 he founded NeuNet. His research interests include **wireless sensor networks, Internet access networks, multimedia systems**, bioinformatics.

# *A Balanced View on Network Neutrality*

## **Dirceu Cavendish**

Kyushu Institute of Technology, USA/Japan

Dirceu Cavendish is an Adjunct Professor at Kyushu Institute of Technology, and a visiting professor at UCLA. He also holds a staff position at Qualcomm Inc. He has done research in packet networks, optical DWDM networks, network and service management, broadcast systems, as well as Distributed Computing/Web Services. His current research interests include **WWAN and WLAN systems, Transport Protocols, and Performance modeling of distributed systems.**

# A Service-Based Model for the Internet Value Chain

Erika Pigliapoco and Alessandro Bogliolo

STI DiSBeF  
University of Urbino

# Agenda

- 1. Introduction**
2. The Internet Value Chain
3. Service-based Value chain
4. Service-based model
5. Market signs
6. Conclusion



# Introduction

- Exponential growth of Internet traffic both in mobile and in fixed networks
- Network operators' revenues cover only OpEx
- The estimated traffic growth in the next 5 years requires CapEx in mobile (fixed) infrastructures which are 50% (30%) higher than currently planned
- Maximum development achieved in a balanced value chain

# Agenda

1. Introduction
- 2. The Internet Value Chain**
3. Service-based Value chain
4. Service-based model
5. Market signs
6. Conclusion

# 5-Stage Internet Value Chain

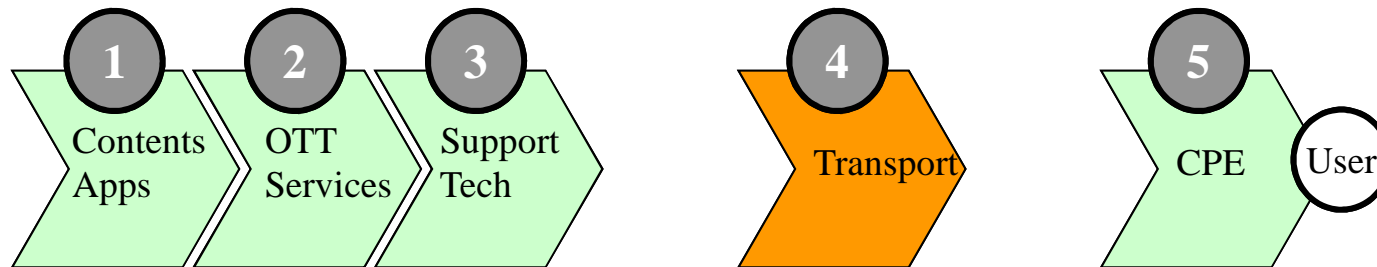

# 7-Stage Internet Value Chain

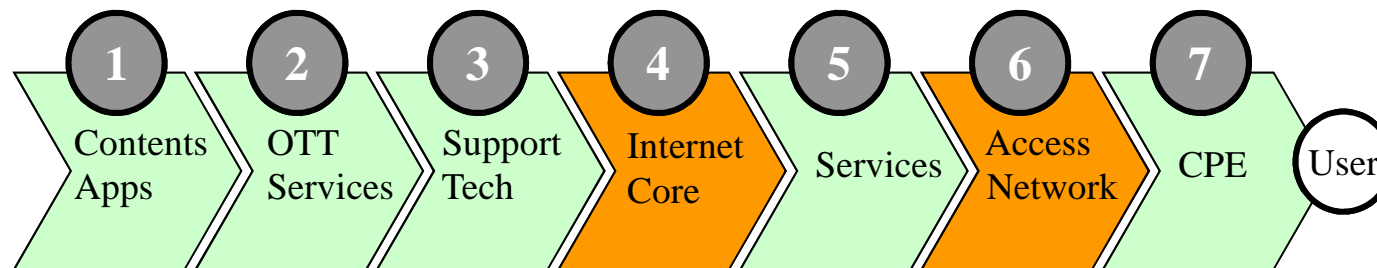

# Imbalance of capitalization (2004-2010)

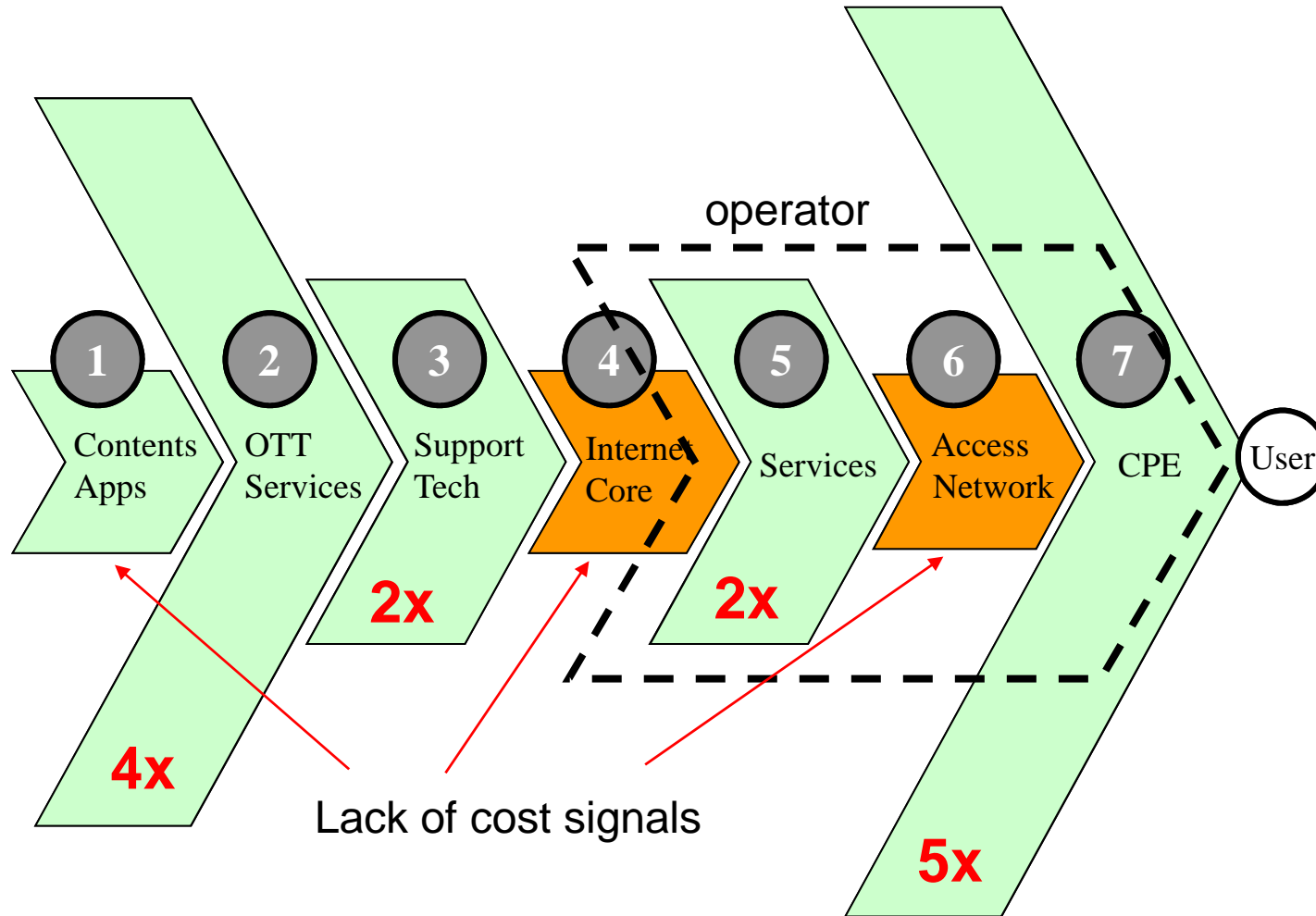

# Agenda

1. Introduction
2. The Internet Value Chain
- 3. Service-based Value chain**
4. Service-based model
5. Market signs
6. Conclusion

# Service-based Value Chain

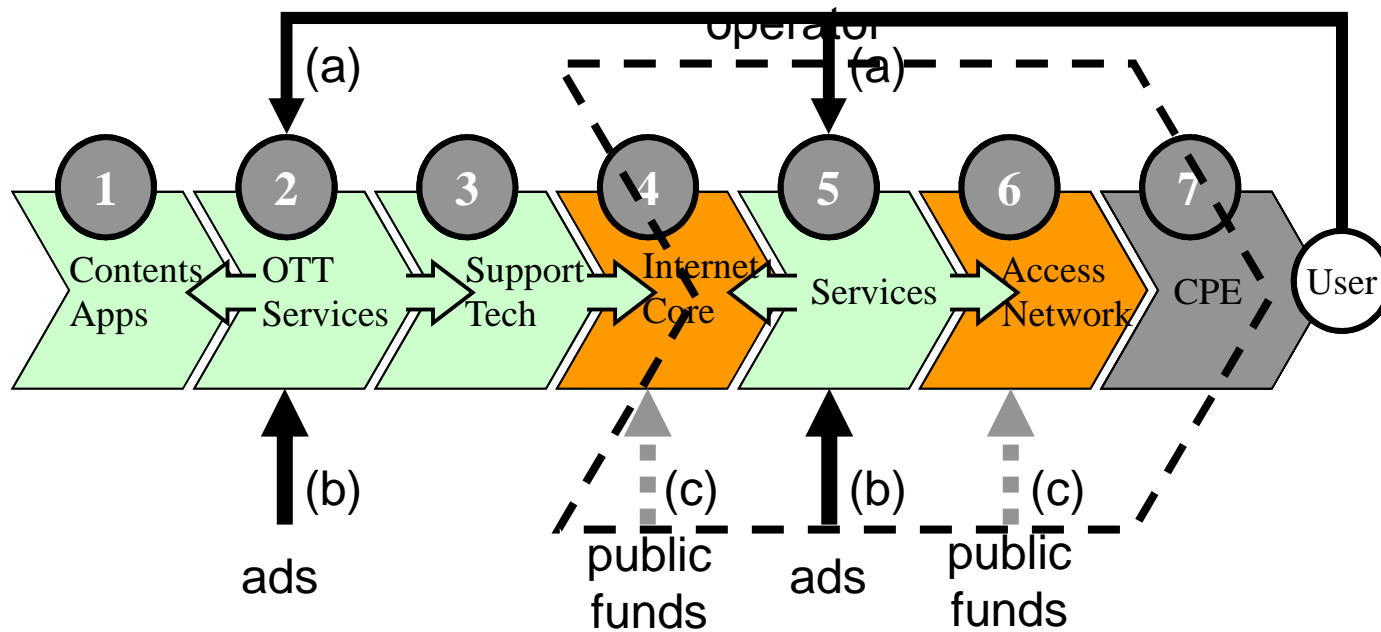

# Agenda

1. Introduction
2. The Internet Value Chain
3. Service-based Value chain
- 4. Service-based model**
5. Market signs
6. Conclusion



# Service-based model

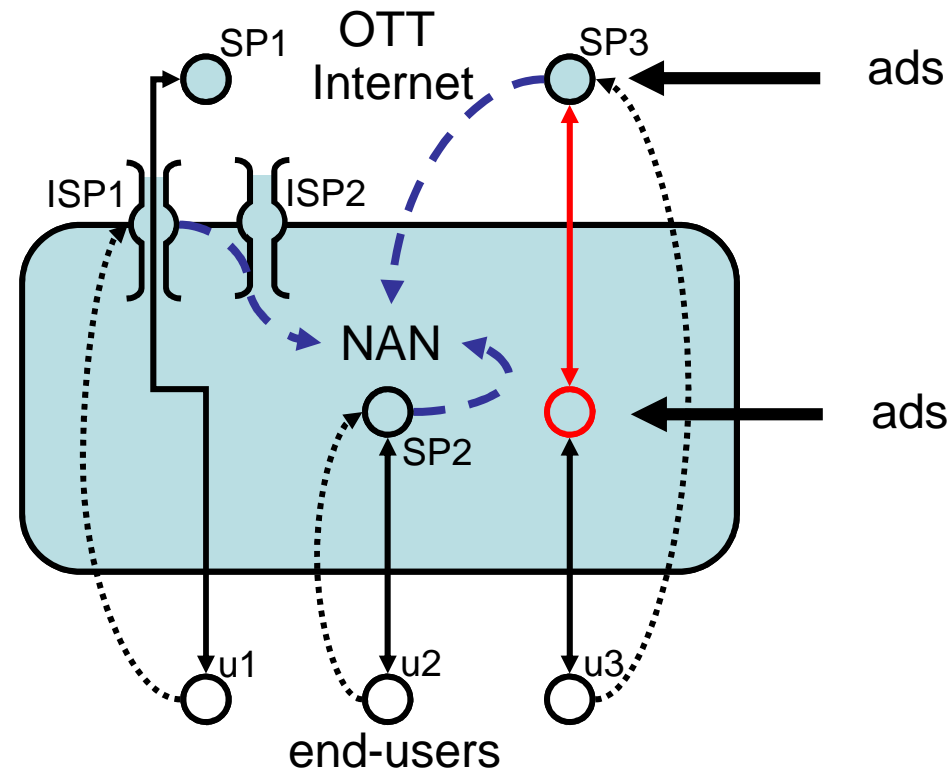

# Agenda

1. Introduction
2. The Internet Value Chain
3. Service-based Value chain
4. Service-based model
- 5. Market signs**
6. Conclusion

# Amazon's Kindle 2

- End-users freed from the burden of connectivity.
- It integrates a hidden SIM card which allows end-users to be always connected (seamlessly) to the online store.
- The cost of download is included into the price of e-books thanks to an agreement between Amazon and AT&T, which in its turn has roaming agreements with mobile operators all around the world.
- Vertical application built on top of a vertically-separated architecture to provide a service-oriented user experience.

# Groupon

- Deal-of-the-day website which operates in hundreds of localized markets worldwide.
- It offers a deal per market per day:
  - If end-users who sign up for the offer reach a given threshold, then the deal becomes available to all of them and the retailer shares revenues with Groupon.
- Groupon works as an assurance contract which guarantees a critical mass which makes the deal like a quantity discount.
- In 2010, Groupon Inc. refused a 6 billion Dollar offer from Google.
- Groupon could provide its services within a NAN, making it available to local end-users even if they have not signed with any ISP.

# Editors against Google

- The *Italian Federation of Newspaper Publishers* (FIEG) triggered an antitrust investigation because most people read aggregated summaries on Google News without following the links to their newspaper
- In January 2011, Google Inc. accepted to disclose revenue-sharing arrangements for its *AdSense* partners.
- Online aggregators and search engines are much closer to end-users than contents (e.g., news), so that it is much easier for SPs than for content right owners to be paid by end-users and sponsors.
- The agreement found in Italy also demonstrates that it is worth for both categories to find a suitable revenue sharing mechanism which reduces the imbalance.

# Operators against OTT-SPs

- Operators demand that popular OTT services (Google, Facebook, Skype, Apple, ...) contribute to pay for the traffic they generate on their networks.
- Request motivated by the lack of return for operators from the exponential growth of IP traffic
- Network neutrality issues raised by the unsuitable business models adopted.

# Public consultations on Net Neutrality

- Digital agenda for europe
- Public consultations launched by all national authorities
- Balance conflicting interests of stakeholders
- Compensate imbalance in the value chain
- Grant sustainability

# Agenda

1. Introduction
2. The Internet Value Chain
3. Service-based Value chain
4. Service-based model
5. Market signs
- 6. Conclusion**



# Conclusion

- Service orientation can grant to the Internet the degrees of freedom required to (autonomously):
  - find the best balance among the segments in the value chain
  - overcome the bottlenecks
  - create the pre-conditions for development



# A Balanced View on Network Neutrality

Open Internet and Net Neutrality  
INTERNET2011 Panel

Dirceu Cavendish  
Kyushu Institute of Technology/UCLA





# Net Neutrality Definition



## ■ Network Neutrality Definition

- All network traffic should be treated equally.
- No restrictions by ISPs or governments on consumers' access to networks serving as gateways to the Internet

## ■ Concerns

- Broadband providers may control access to the Internet in ways to stifle competition, tilt markets, discriminate specific usage

## ■ Internet Network Neutrality dimensions

- **Charges** independent of content
- **Transport** independent of content



# Is Net Neutrality a New Issue?



- **Phone networks have long been non-neutral**
  - **Local vs long distance charges**
  - **Premium services (1-800 numbers)**
  
- **Carriers motivation**
  - **Better capitalize on network infrastructure**
  - **Service Innovation**



# Carrier's Perspective



- **Net neutrality regulation may push carriers to bit transmission commoditization**
  - **Non-differentiated transport and charge rates**
  
- **Net neutrality regulations may limit carrier ability to efficiently manage its network infrastructure (traffic management; network planning)**
  - **Access networks may have specific capacity characteristics (e.g., DOCSIS, mobile)**
  - **Unsupervised applications may cause undesired consequences to networking infrastructure**
    - **P2P**
    - **Open source OS threats**
      - **Transport protocols**
      - **Malicious applications**



# Subscriber's Perspective



- **Residential subscribers**
  - **Unpredictable charges for non-neutral Internet (similar to cell phone roaming charges)**
  - **Delivery driven by carrier's objectives, not customer satisfaction**
    - **Applications blocking (P2P, FTP, Online gaming)**
  
- **Commercial subscribers**
  - **Business' health depends on connectivity/transport**
  - **Service charge and delivery needs to be clearly defined**



# Revenue Generating Internet



- **Web Services:** from Airline to Retail Industry, Internet commerce is ever more active
- **Data mining:** From Google to digital libraries, information search generates billions of dollars (advertising and subscription)
- **Social Networking:** Internet games and social activities have grown considerably. Facebook and others are reaping profits from online advertising.

**Shouldn't carriers charge according to the value of the bits delivered?**

- Postal services
- Transportation companies



# Net Neutrality Summary



- **Traffic Delivery: Are there non-discriminatory differentiated traffic transport?**
  - Transport delivery policies transparent to users
  - Users' demands curbed by transparent contractual caps, enforced by access technologies (e.g., DPI)
  
- **Service Charges: Are there non-discriminatory differentiated charges?**
  - Should not be based on application business models.
  - May be based on delivery quality, and network resource usage
  - Should be monitored by trusted parties.
  
- **Carrier and Business relationship**
  - Partnership may stifle competition (e.g., Bing traffic preferred to Google traffic)
  - Customer access/traffic blocking may be hard to detect

## Net Neutrality Position Statement

- Allow the carriers to differentiate charges and delivery for the right reasons
  - Traffic management; delivery QoS differentiation; curbing end-point abuse (e.g. DPI)
- Prevent carriers to differentiate charges and delivery for the wrong reasons
  - Value of bits delivered (Google vs myBlog)
  - User profile (type of application, etc)







# Backup Slides



**INFOWARE 2011**

**PANEL: Internet/Access  
Open Internet and Net Neutrality**

**Network neutrality versus content  
aware/oriented networking**

*Eugen Borcoci  
University Politehnica Bucharest*



# Network neutrality versus content aware/oriented networking



## ■ Acknowledge

- The information presented in these panel slides are compiled from public information and with approval of ALICANTE project consortium approval
- Sources
  - European FP7 project: 4WARD - A clean slate approach for Future Internet, FP7 IP Project (2008-2009)
    - Abramowicz, H. Introduction to BIRD WS, <http://www.4ward-project.eu>
  - Van Jacobson Diana K. Smetters James D. Thornton Michael F. Plass, Nicholas H. Briggs Rebecca L. Braynard, Networking Named Content, Palo Alto Research Center, Palo Alto, CA, October 2009
  - European FP7 project : ALICANTE - MediA Ecosystem Deployment Through Ubiquitous Content-Aware Network Environments, 2010-2013, FP7 Integrated Project



# Network neutrality versus content aware/oriented networking



- **Network neutrality: hot topic in discussion**
  - Operators, Industry, Research, Governments, Regulation bodies, User communities
  - For current and also Future Internet
  
  - **Neutrality defenders**
    - Original TCP/IP principle - defenders
    - Mainly - application developers, users
    - Governments ( see FCC- 2010 - recent decision...)
      - Some reasons: Afraid of monopoly and limited opening to new developments
  
  - **No (more) - neutrality defenders**
    - Mainly - ISP, operators
    - Groups of users /entities wanting guarantees for QoS, security, availability, dependability, security, etc.
    - Example : NGN/IMS – is not (completely) neutral
    - Some reasons:
      - ISP overloaded by P2P/video traffic,
      - Operators wanting more profit from users paying for services
- **Question**
  - Who is right?
  - There exist a middle way?



# Network neutrality versus content aware/oriented networking



## ■ Historical evolution:

- Best effort Internet ( still - in use on a large scale) ( ~1970)
- Qos-based virtual splitting (Intserv/DiffServ, MPLS) (~1995)
- VPNs + QoS, security, ...
- Content oriented networking ( ~2005)
  - Content- type aware networking (CAN)
  - Content – objects oriented networks
  - Example CCN ( V.Jacobson et. Al., 2009)
- Alternative: Service/application aware networking
  - and
- Network Aware Applications
- E.g. CAN:
  - special processing (routing/forwarding, QoS, security, filtering, caching, etc.) of packet flows
  - based on content-type information ( extracted fom the packets, metadata or signalling- obtained)

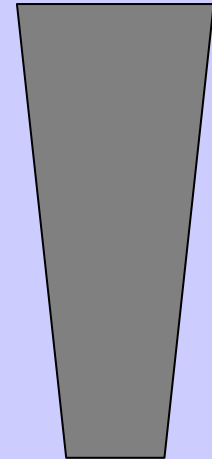

Degree of neutrality



# Network neutrality versus content aware/oriented networking



- **About terminology..**
  - Not standardised, different (overlapping) semantics...
    - **CAN- Content Aware Networking**
    - **CON - Content Oriented Networking**  
example: **CCN - Content Centric Networking**
    - **SON – Service Oriented Networking**
    - **NAA- Network Aware Applications**
  - This presentation - approach:
    - CAN – is seen as having a more general scope  
**Awareness of content type**- low granularity, less overhead  
and /or **Awareness of each content object**- high granularity, more overhead
    - CON: basic meaning- dealing with *content objects*: **nam<sup>ing</sup>**, **locating/routing**, **deliver/disseminate**, **caching in-network**  
CCN – particular case of CON



# Network neutrality versus content aware/oriented networking



- **Content-Aware Network (CAN) and Network Aware Application (NAA) - Concepts (basic CAN)**
  - **Traditional approach:** the way contents are generated, processed, and distributed are separated from the way they are transported
  - Question: can one better serve the application flows by inserting more intelligence into the network? ( but still preserving the architecture modularity)?
  - CAN : adjusting network resource allocation based on limited understanding of the nature of the content → differentiate the processing of traffic flows – **no more neutrality**
  - NAA: network-aware content processing : adjusting the way contents are processed and distributed based on limited understanding of the network condition

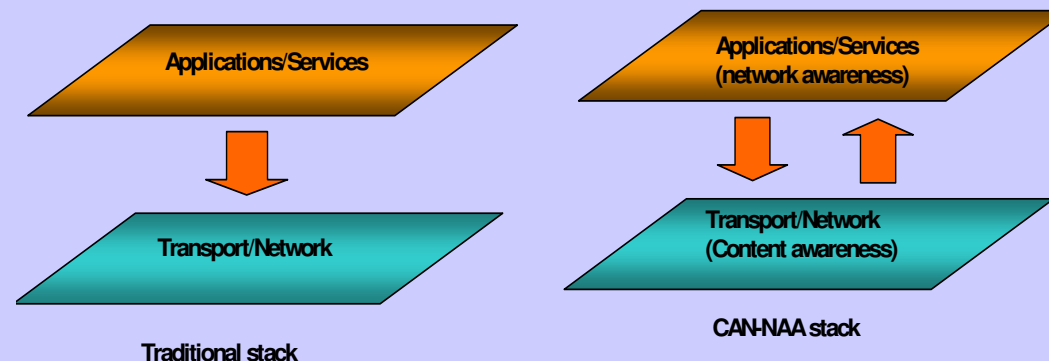



# Network neutrality versus content aware/oriented networking



## CCN concepts Example

CCN transformation of the traditional network stack from IP to chunks of named content

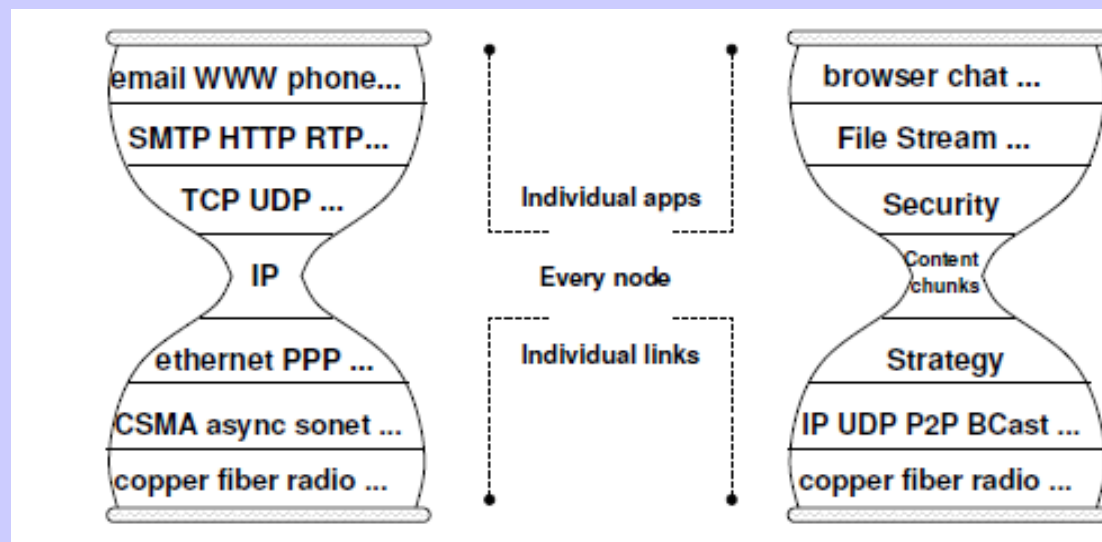

Traditional  
TCP/IP stack

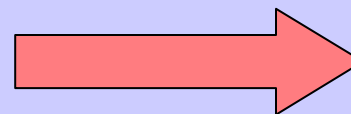

CCN

Source: Van Jacobson Diana K. Smetters James D. Thornton Michael F. Plass, Nicholas H. Briggs  
Rebecca L. Braynard, Networking Named Content, Palo Alto Research Center, Palo Alto, CA,  
October 2009





# Network neutrality versus content aware/oriented networking



- Possible (trade-off) solution ??
  - Content/Service awareness at network layers and specialised/differentiated processing of different types of flows/content
  - Plus virtual parallel Internets, customised
    - Among them, a given amount of resources can be still allocated to complete neutral style network i.e. – Best effort

# Network neutrality versus content aware/oriented networking

- **Case Study Example 1**
- Source: European FP7 project: 4WARD A clean slate approach for Future Internet, FP7 IP Project (2008-2009)
- 4WARD proposes a full virtualisation (Data Control and Management Plane) plus specialised treatment in the network ( see generic paths)

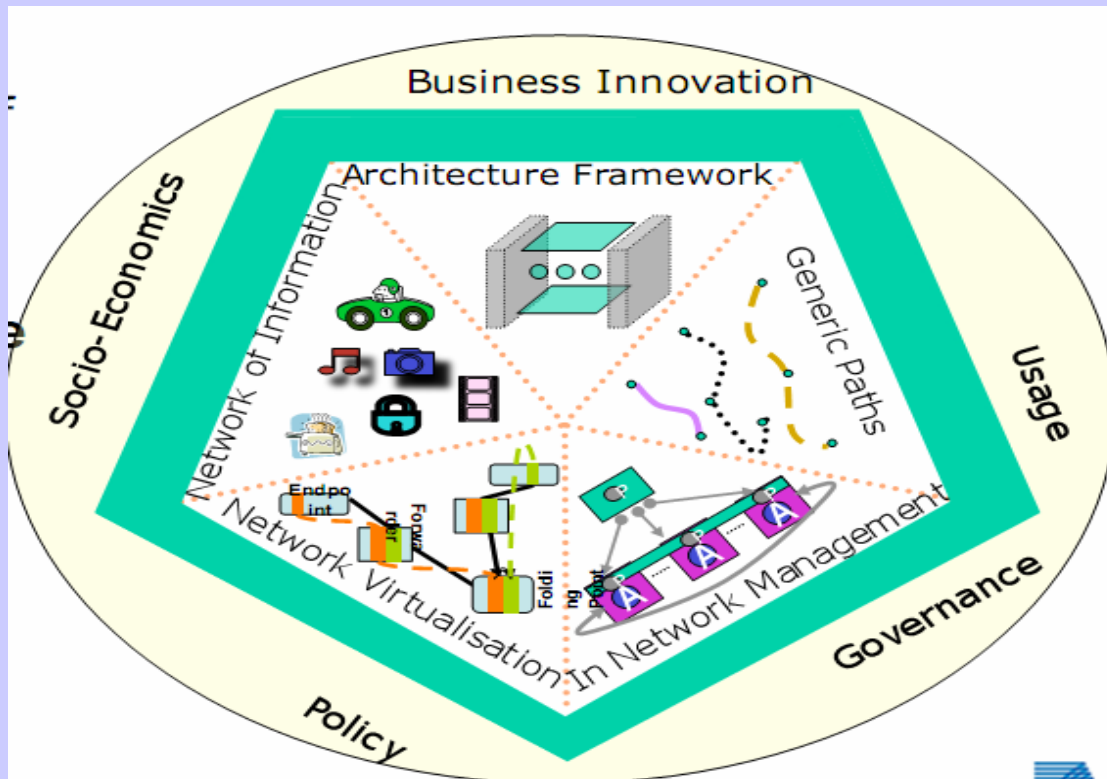

Source: ...Abramowicz,H. Introduction to BIRD WS,  
INFOWARE 2011Conference, June 19-24 Luxembourg

- **Case Study Example 1**
- **Example of full virtualisation**
- Overview of a virtual network topology and substrate networks

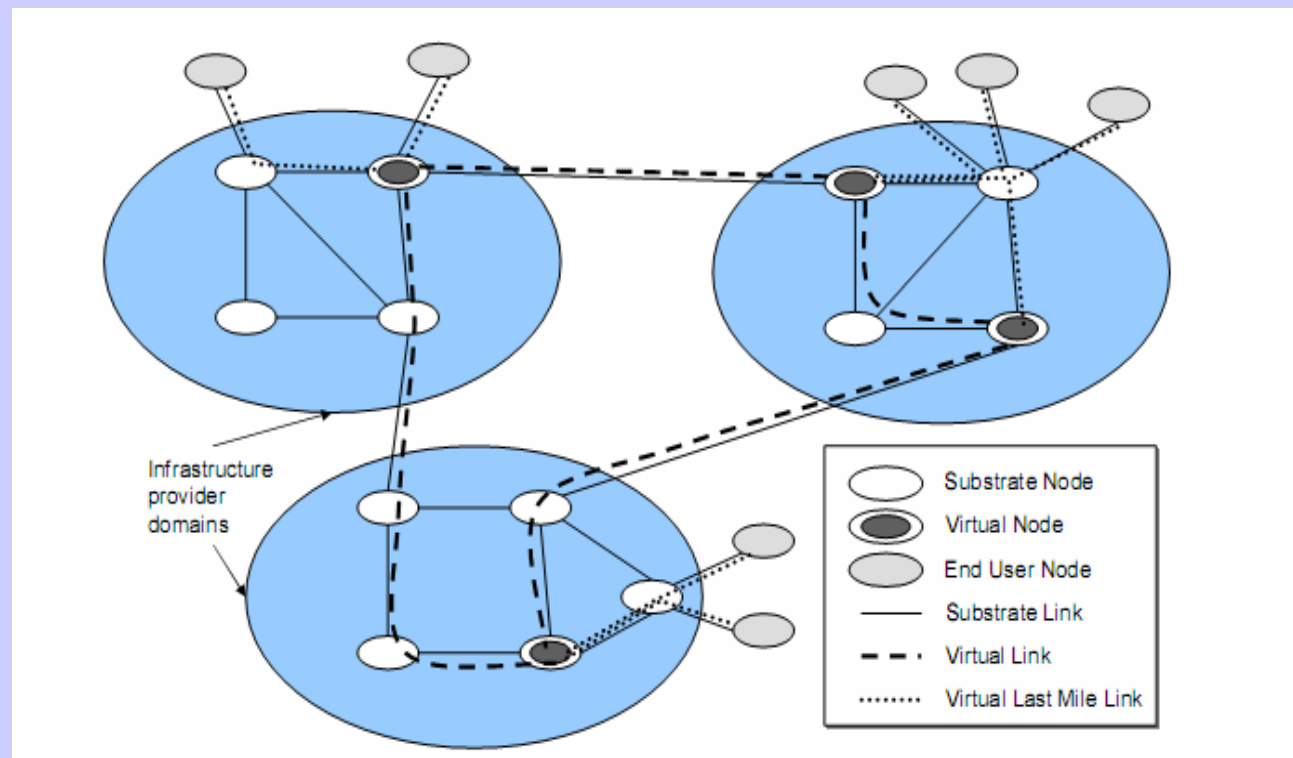

R.Bless, C.Werle, Control Plane Issues in the 4WARD Network Virtualization Architecture, Electronic Communications of the EASST Volume 17 (2009)

- **Case study example 2: Alicante Project**
- **Media Ecosystem Deployment Through Ubiquitous Content-Aware Network Environments ALICANTE, 2010-2013, FP7 Integrated Project (IP)**

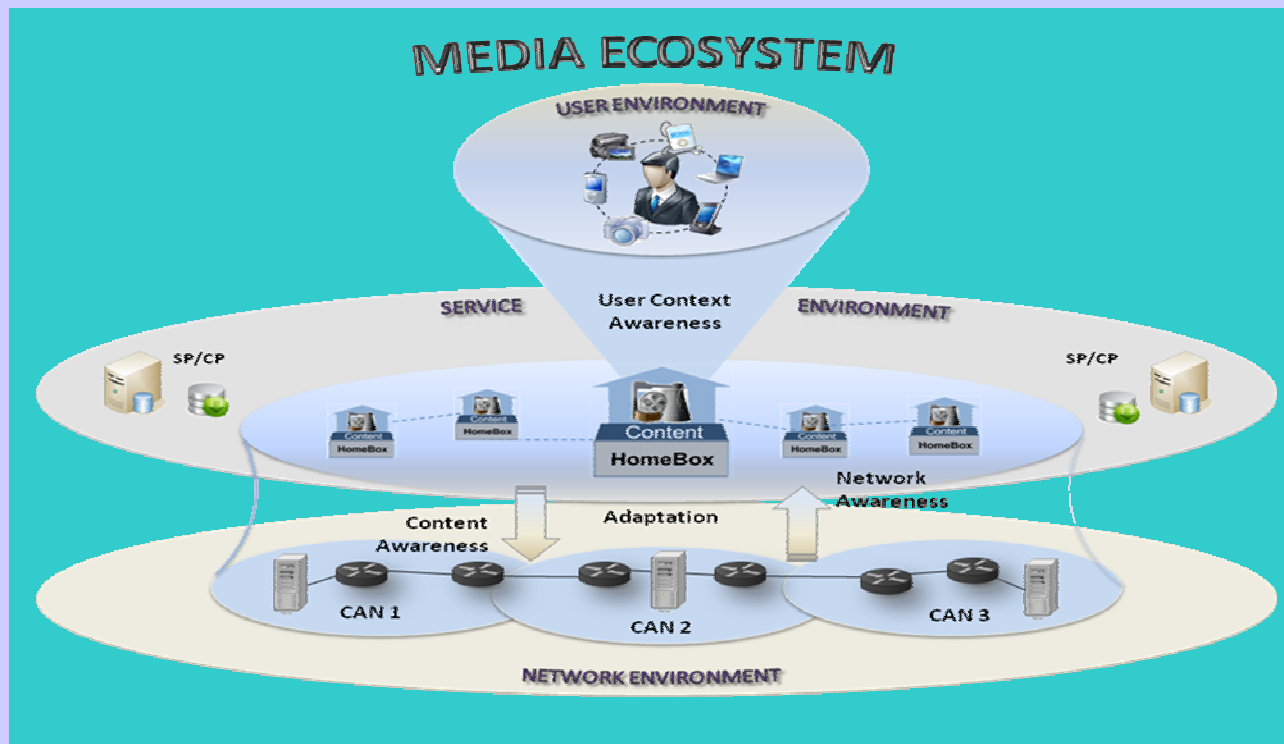



# Network neutrality versus content aware/oriented networking



- **Example 2 ALICANTE project**
- Non-neutral network example: Content-type awareness + parallel virtual planes
- However BE style can be preserved

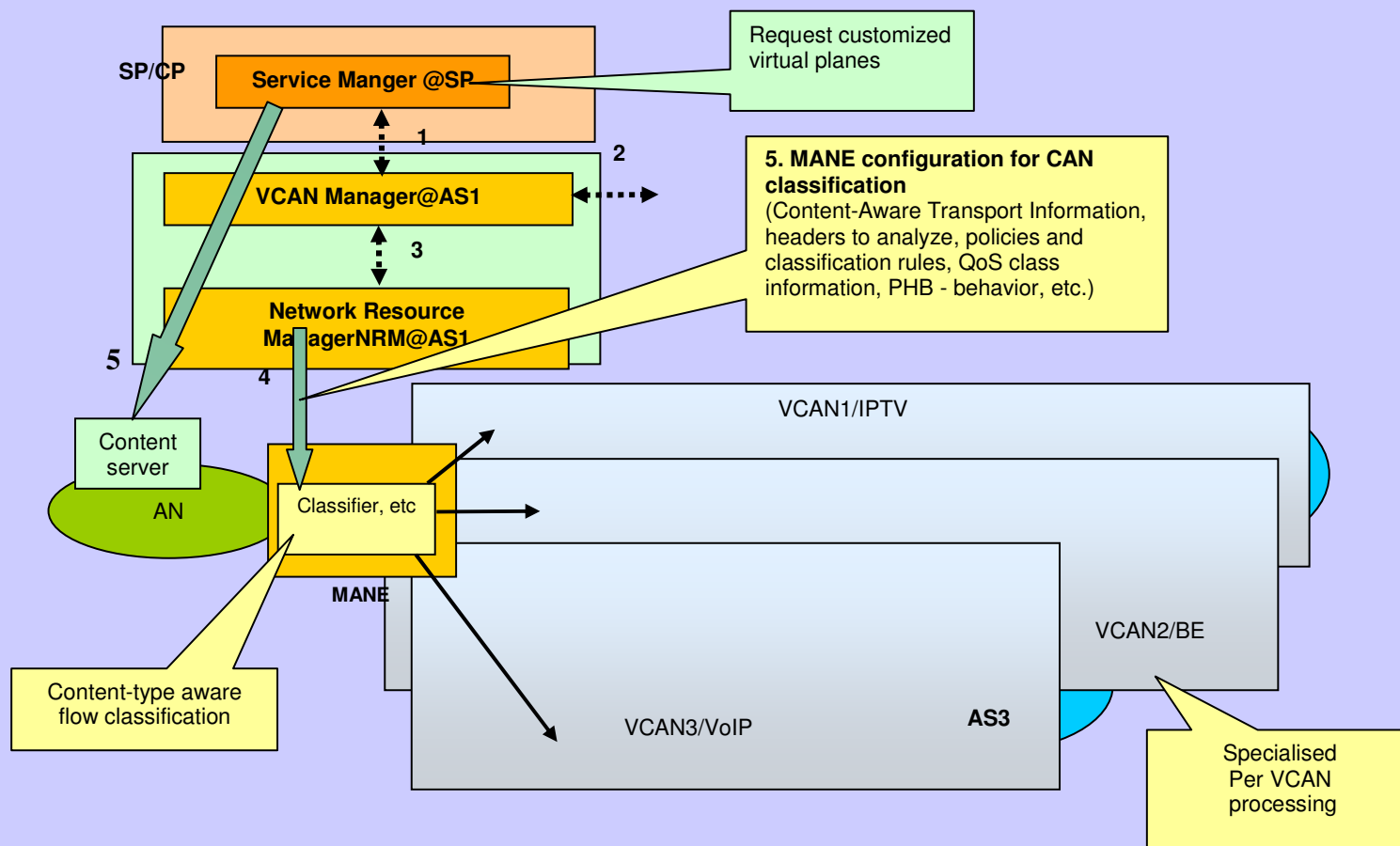



# Network neutrality versus content aware/oriented networking



## ■ CONCLUSIONS

- NET neutrality: it is not a binary problem
  - yes/no answer is not appropriate
  - Large ranges of intermediate solutions may exist
  
- Solutions exist in FI to cope with different partners/actors interests
  - Differentiated treatment in the network depending on content/service, plus BE treatment of flows
  - Based on virtual parallel planes (customised Internets)



# Network neutrality versus content aware/ oriented networking

---



Thank you !

MNM  
TEAM  
MUNICH NETWORK MANAGEMENT TEAM

DFN  
Deutsches  
Forschungsnetz



# Network neutrality at risk – staying at the edge of the abyss?

Mark Yampolskiy



# Network Neutrality

---

- ▶ Treat all IP packets equally, regardless of ...
  - ▶ Origin or destination of flow
  - ▶ Service they are used in
  - ▶ Protocol or port
  - ▶ ...

**Do we really want this ?**

# Dimensions of Discussion

---

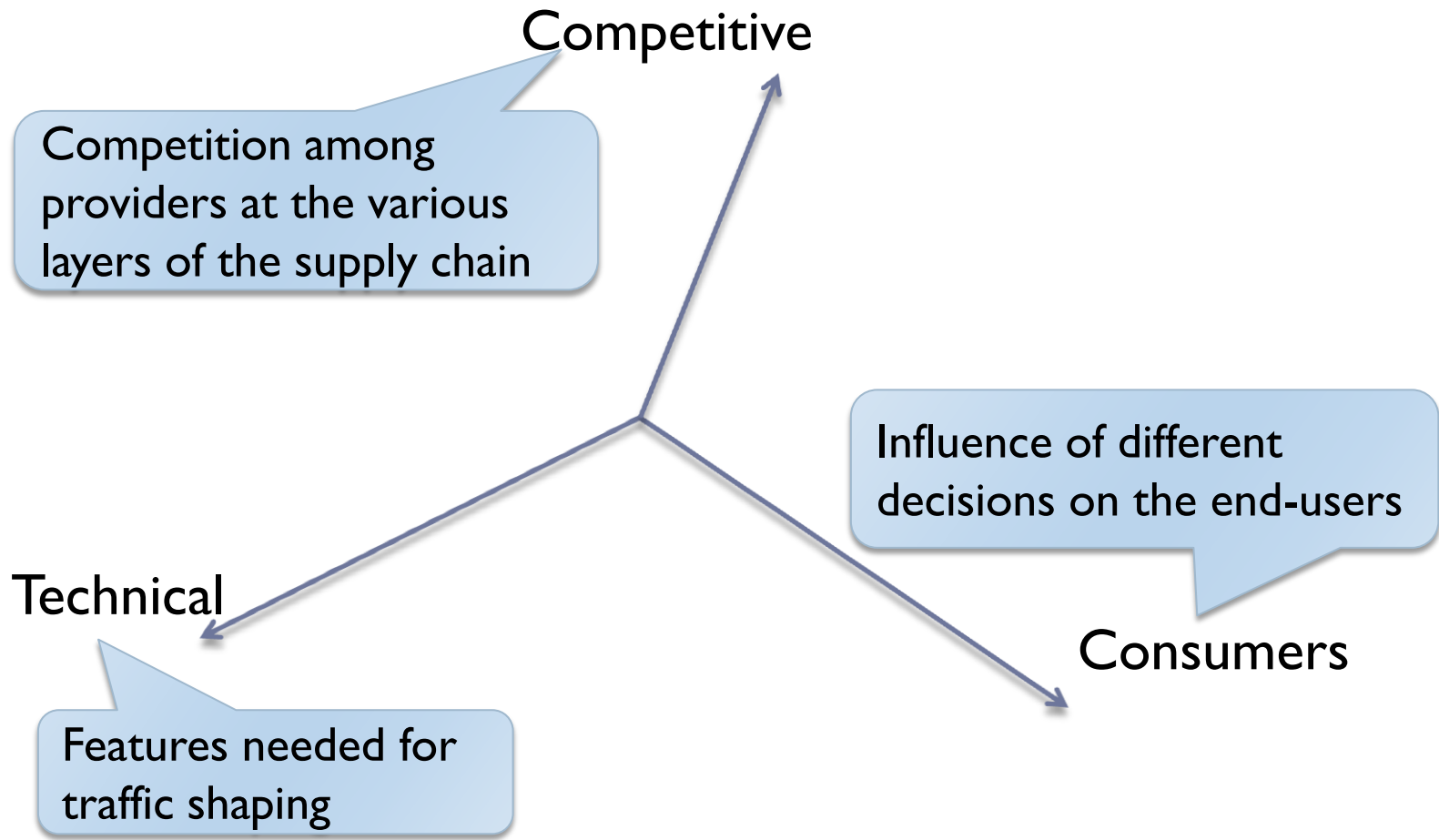

# 100s Reasons for and against it

---

## Stay neutral

- ▶ **The mighty ISP**
  - ▶ Booting out competitors
  - ▶ Says which services are bad
- ▶ **Big Brother watching you**
  - ▶ First DPI – what next?
- ▶ **Endanger Innovation**
  - ▶ Booting out start ups
- ▶ **“More bandwidth will solve everything”**

## Or choose the “color”

- ▶ **Different services – different needs**
  - ▶ Telemedicine vs. File-sharing
  - ▶ File transfer vs. gaming/VoIP
- ▶ **Different customers – different needs**
  - ▶ Commercial vs. private
  - ▶ Networks at home vs. in Research collaborations

# Welcome to the Reality

---

## Reality now

- ▶ Internet today
  - ▶ DSL at home: choose speed
  - ▶ CDN: Akamai, ...
- ▶ Géant services
  - ▶ Premium IP
  - ▶ E2E Links
- ▶ Research projects in ...
  - ▶ Bandwidth reservation
  - ▶ Content awareness

## EU Position

- ▶ “... *network neutrality is not a technical question to be answered by regulatory authorities*”,

Viviane Reding, 2008

- ▶ So far close to no misuse
- ▶ Interested in NGN deployment

# Old Master Says ...

---

*“Net Neutrality is NOT saying that one shouldn’t pay more money for high quality of service. We always have, and we always will.”*

**(Berners-Lee, 2006)**